

CHRISTIE

ICON Series

Standard All-access Barbecue

The ICON barbecue cabinet is a modern interpretation of our industry-defining Modular Series. The contemporary aesthetic incorporates current trends and legislative requirements around sustainability, inclusivity, and occupational health and safety.



KEY FEATURES:

- Disability Discrimination Act (DDA) compliant, enabling seated and standing users of all abilities to cook
- Sleek low-profile benchtop with large food preparation space
- Split doors with a raised waste container for ease of removal and cleaning
- Quick-release doors for service, cleaning or changing the swing direction
- All components and panels can be replaced on site
- Explicitly designed for use with our celebrated high-efficiency CC2 cooktops
- Corrosion resistant, low maintenance 304-grade stainless steel construction
- Flat-packed for easy site access and reduced freight costs
- Fast, simple assembly by any competent person

COLOUR OPTIONS:

Brushed
stainless steel

Monument
powder coat

Weathered Steel
powder coat

Off-the-shelf finishes with five day lead times: #4 Brushed stainless steel; Dulux Weathered steel or Monument powder coating. Click [HERE](#) to view more standard powder coating colour options (lead times apply).

Note: Custom colours are also available at extra cost.

OPTIONS:

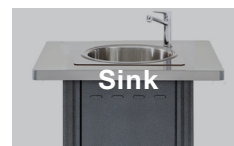
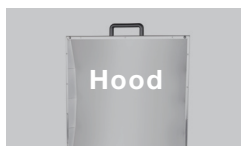

Christie ICON Series Standard Cabinet

Dimensions:

Width 945 mm
Depth 1000 mm
Height 860 mm

Weight: 70 kg

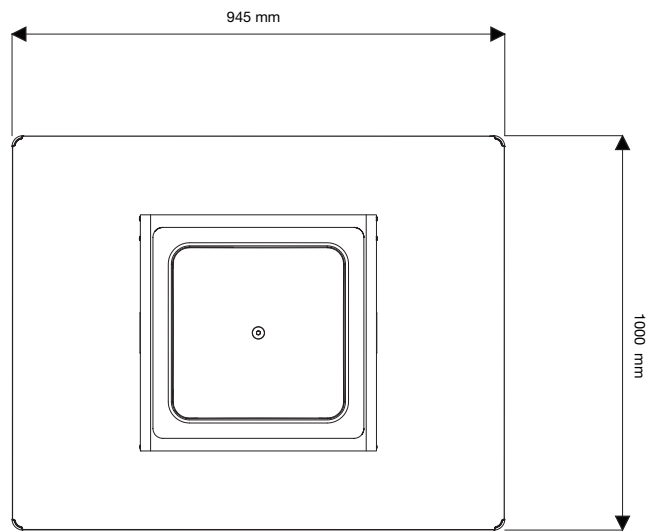
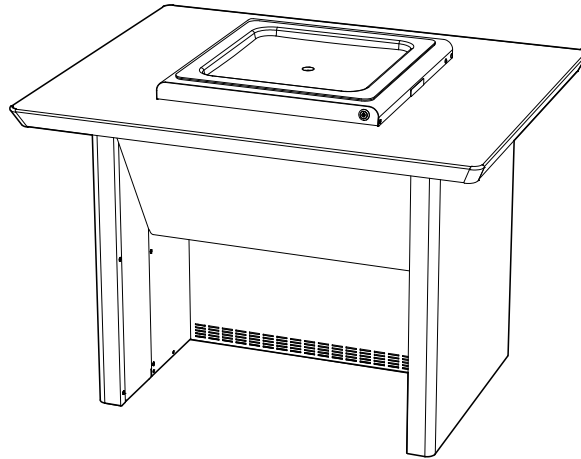

Top View

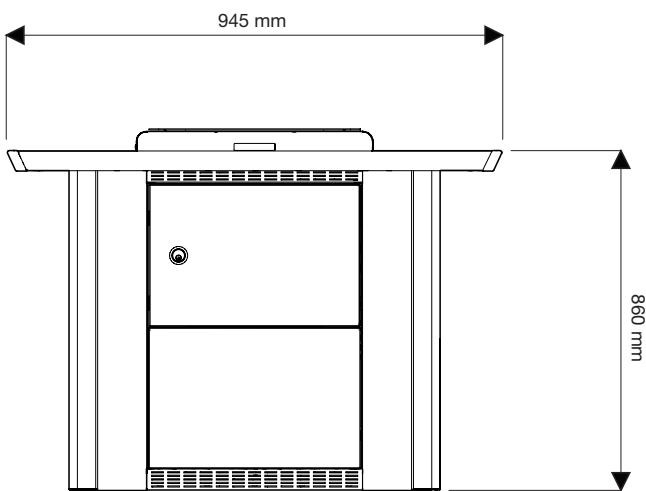

Rear View

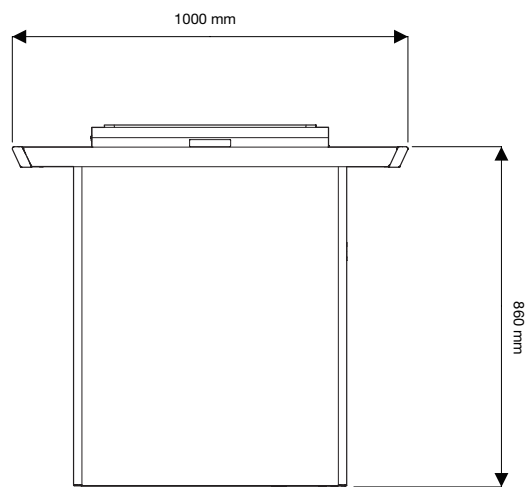

Side View