



Fracture Two-Tone Panel

FilaSorb™ 12 + FilaSorb™ 2

acoufelt
making quiet

Product Detail

Application Wall
Composition 100% polyester
Material FilaSorb™
Recycled content 60% min
Dimensions 1180 x 2780mm
 Custom size available upon request
Thickness 14mm +/- 10%
 12mm backing panel + 2mm skin

Guarantees

Warranty against defects 20 years*
Light fastness warranty 20 years*
 *conditions apply

QuickShip

QuickShip Standard (Made to Order)



Our standard made to order products have an approx. **2-3 week** lead time from payment and order confirmation.

Technical Data

Fire rating Pending results
Indoor air quality SCS-EC10.3-2014 v4.0 meeting standard CDPH/EHLB Standard Method v.1.2-2017, $\leq 0.5\text{mg}/\text{m}^3$
Color fastness ISO 105-B02, 6-7

Sustainability



Made from 60% min. recycled content



Recyclable at end-of-life

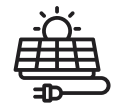

Generated using 40% solar energy



Phenol & formaldehyde free



Total VOC's less than $0.5\text{ mg}/\text{m}^3$ (3rd Party Verified)



Acoustic Performance

Test method ISO 354-2006
Results NRC 0.45 (no air gap)
 NRC 0.54 (12mm air gap)
 NRC 0.64 (20mm air gap)
 NRC 0.85 (200mm air gap)

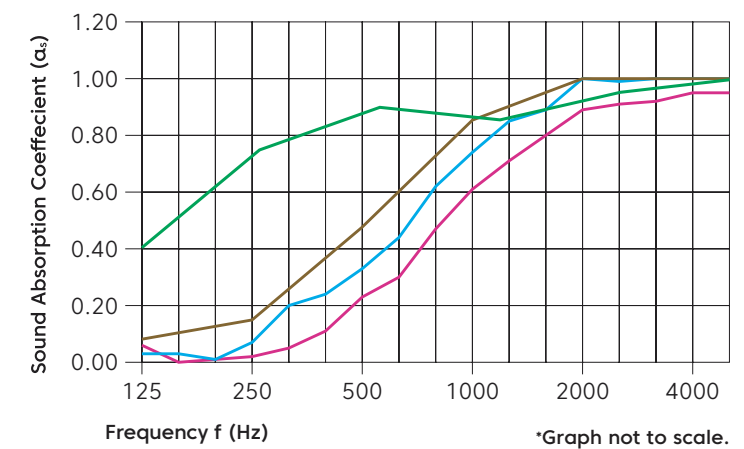

Frequency (Hz)	125	250	500	1000	2000	4000	NRC
α_s no air gap	0.06	0.02	0.23	0.61	0.89	0.95	0.45
α_s 12mm air gap	0.03	0.14	0.33	0.74	1.00	1.00	0.54
α_s 20mm air gap	0.05	0.16	0.48	0.85	1.00	1.00	0.64
α_s 200mm air gap	0.40	0.75	0.90	0.85	0.95	1.00	0.85

Designs

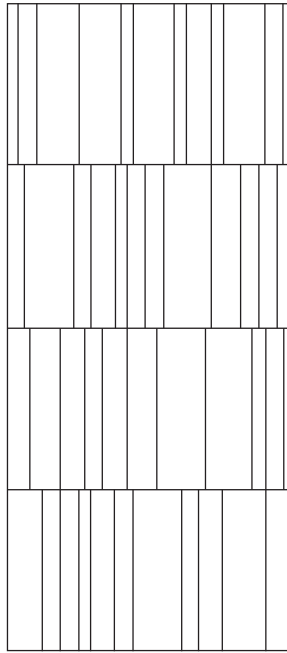

Barcode

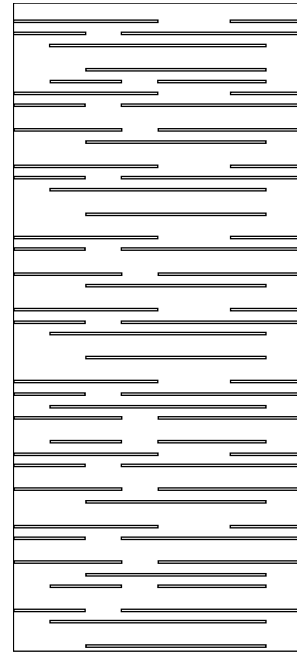

Dash

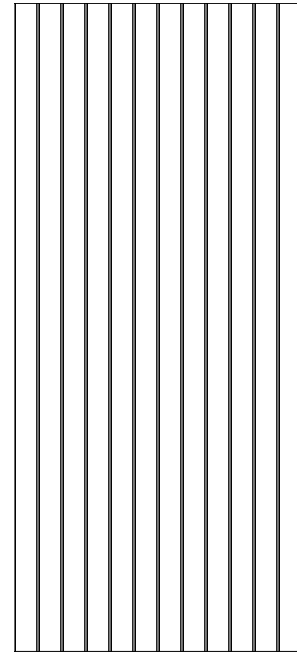

Fineline

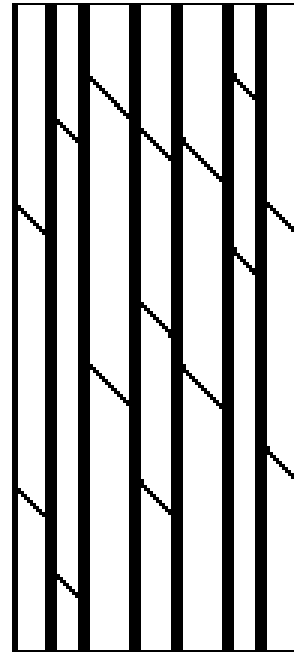

Optics

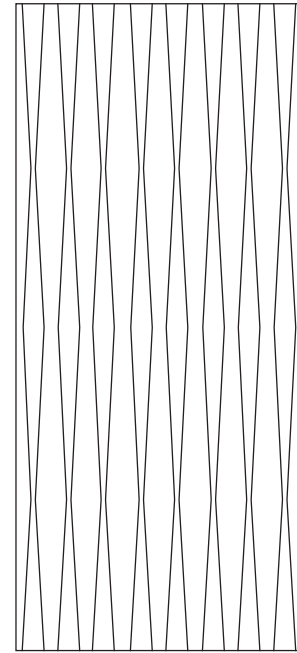

Parallax

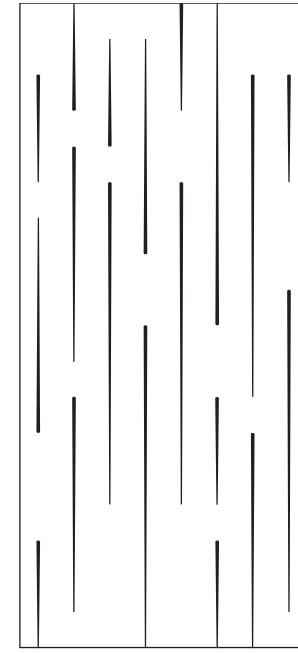

Raindrop

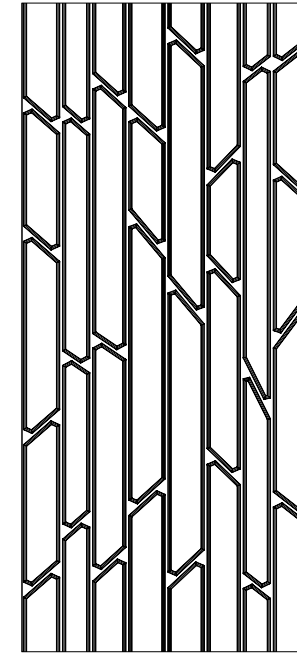

Shard

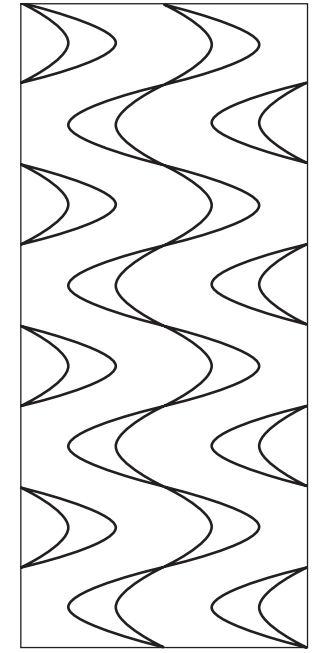

Smoke

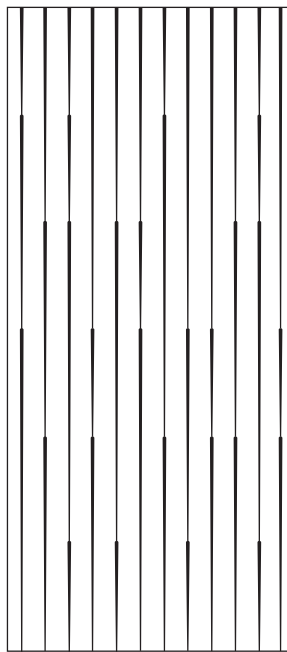

Thread

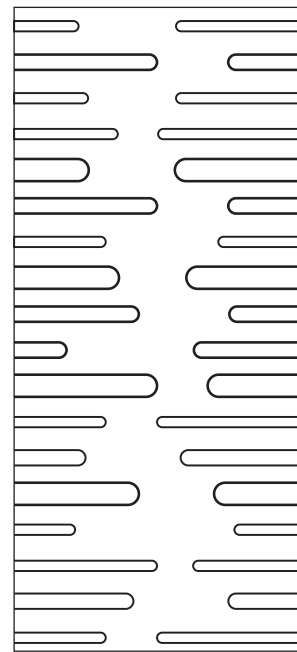

Vapor

Design

Elevation

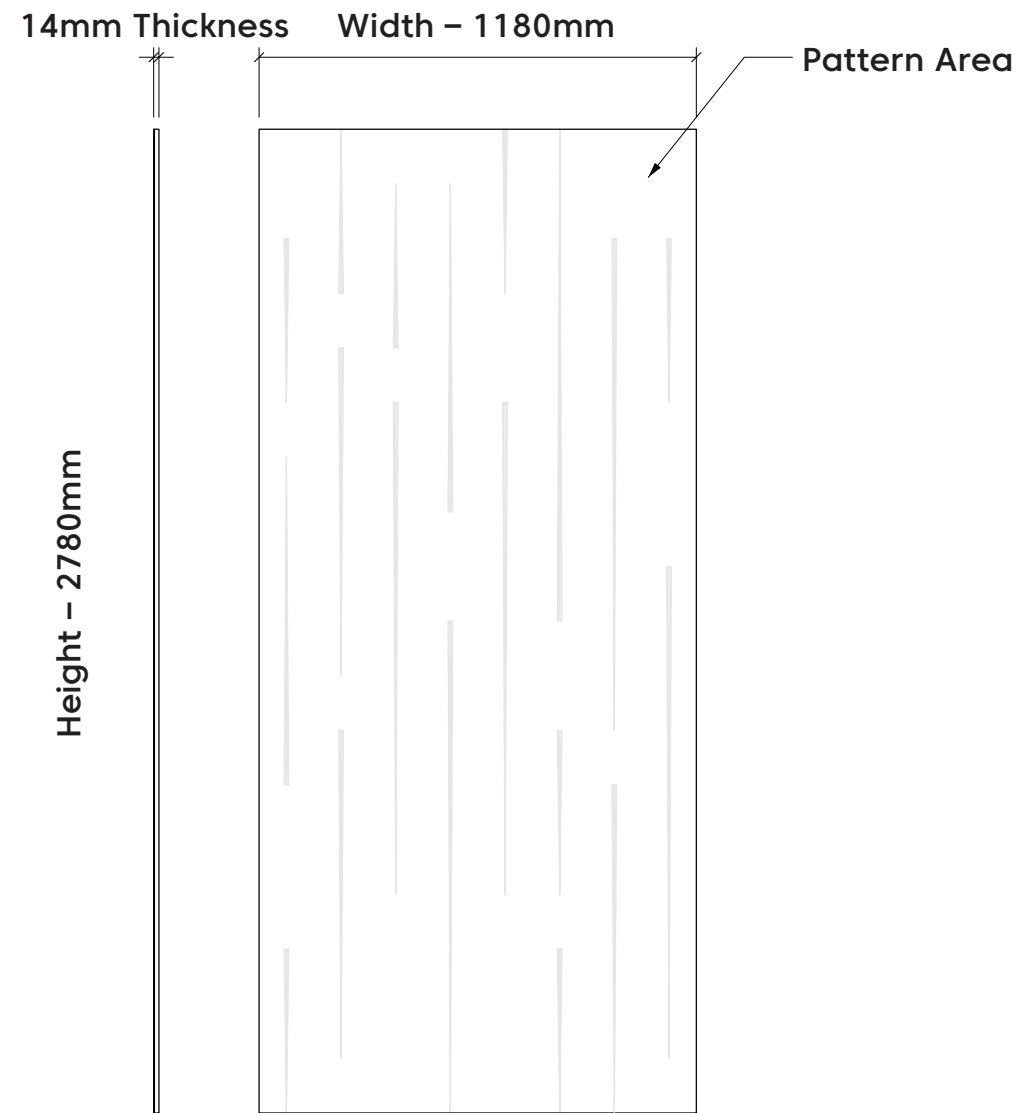

Perspective

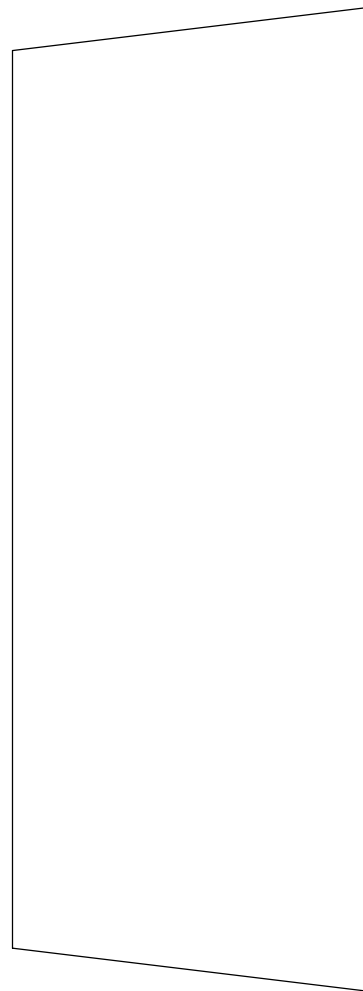

3D View

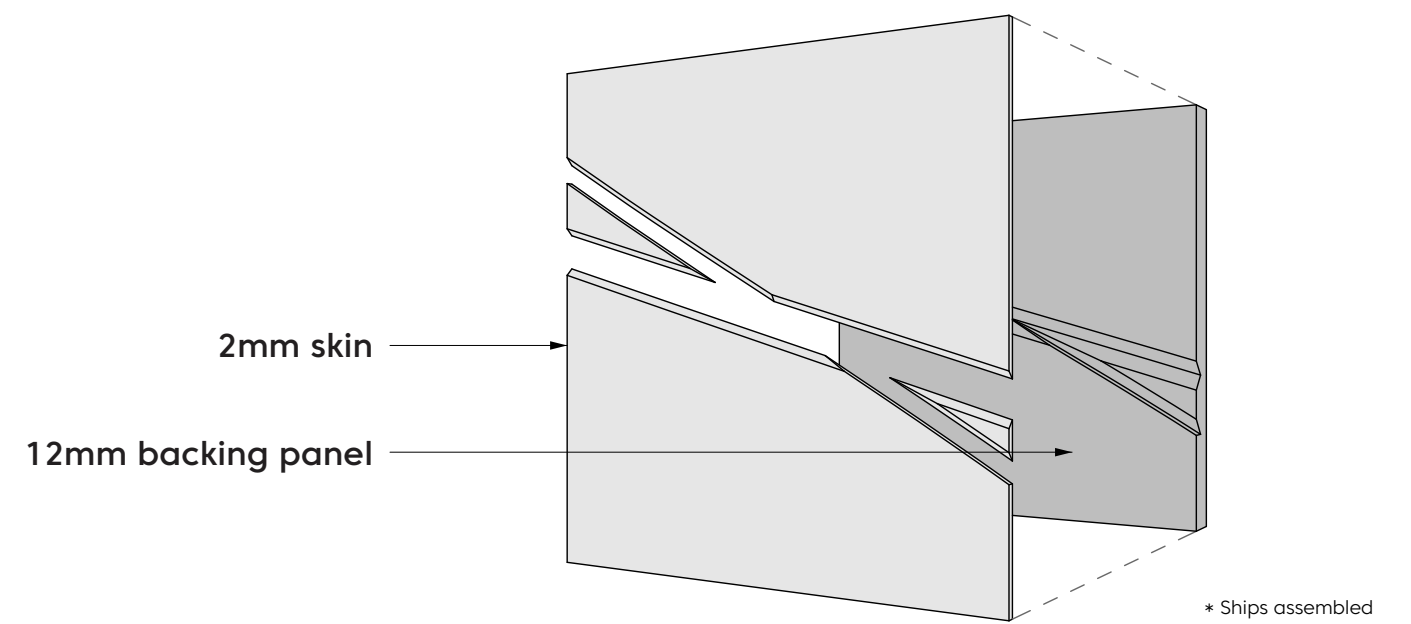

Barcode Pattern

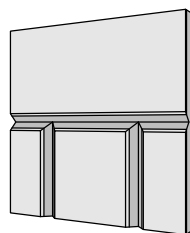
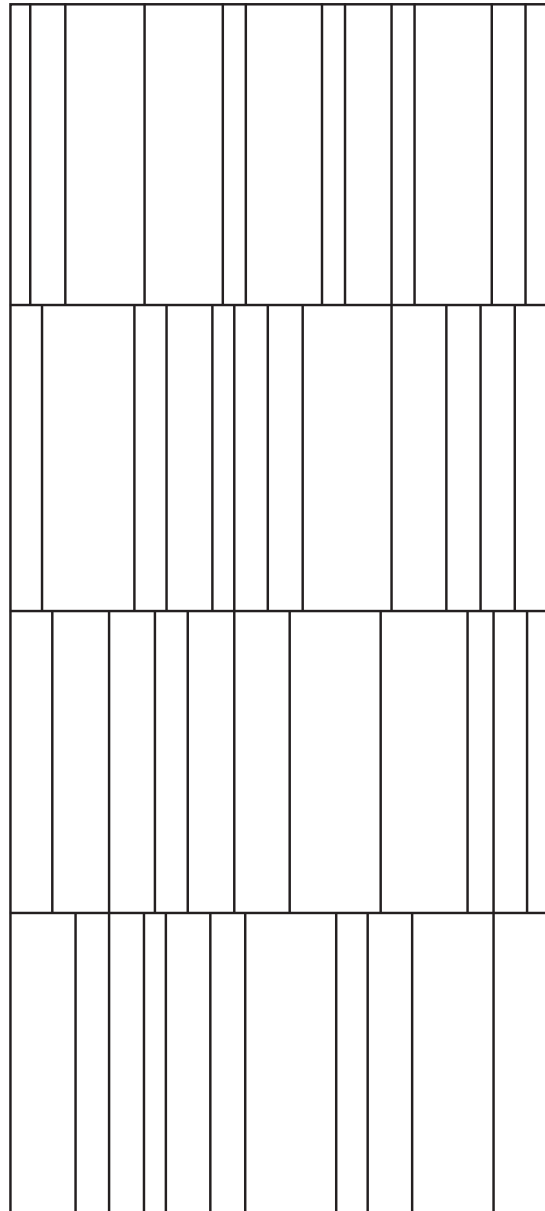

* Enlarged Detail

Recommended Layouts

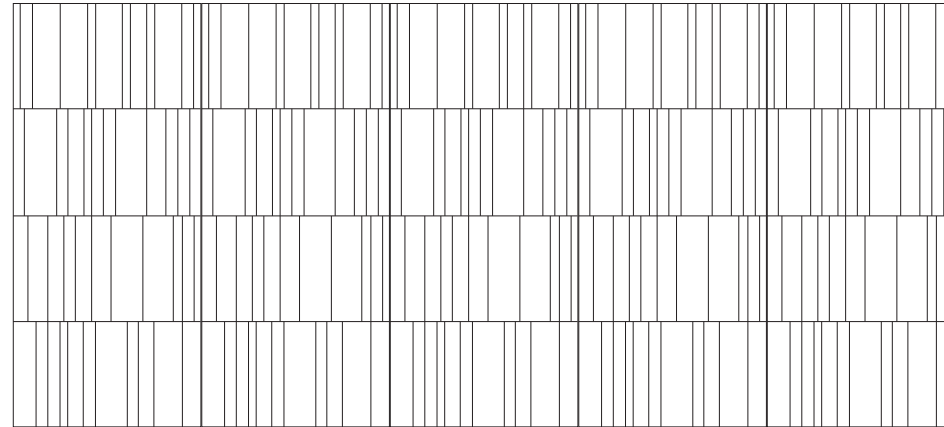

Layout 1

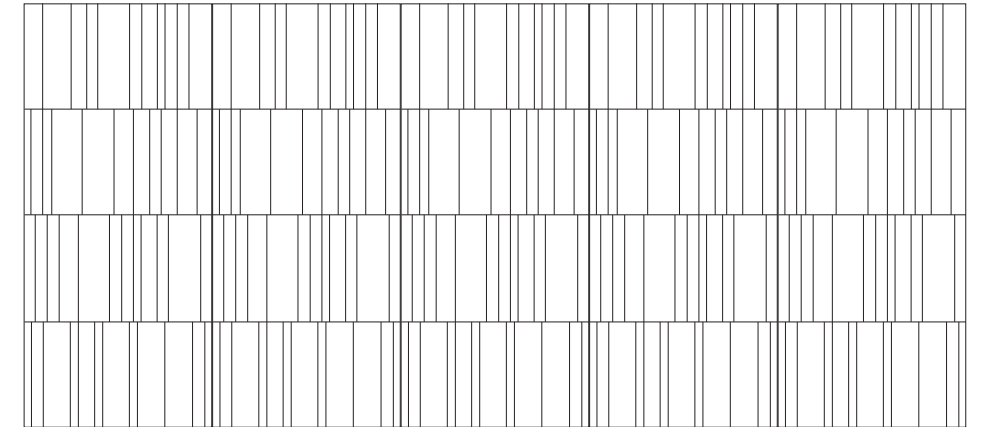

Layout 2

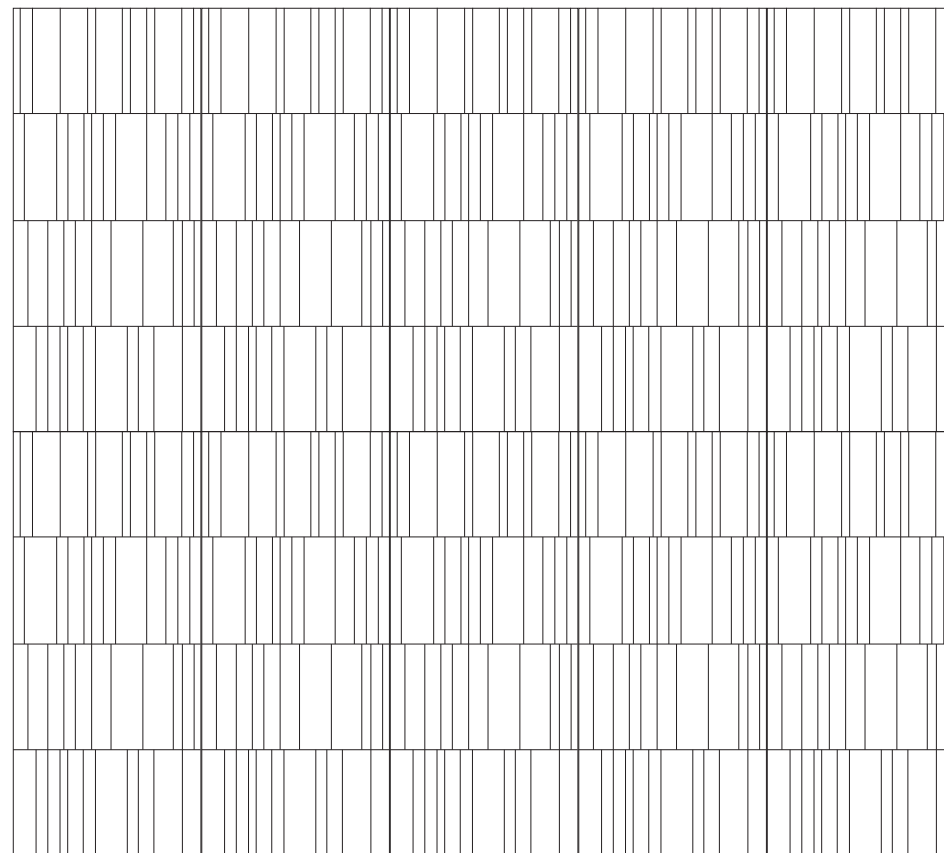

Layout 3

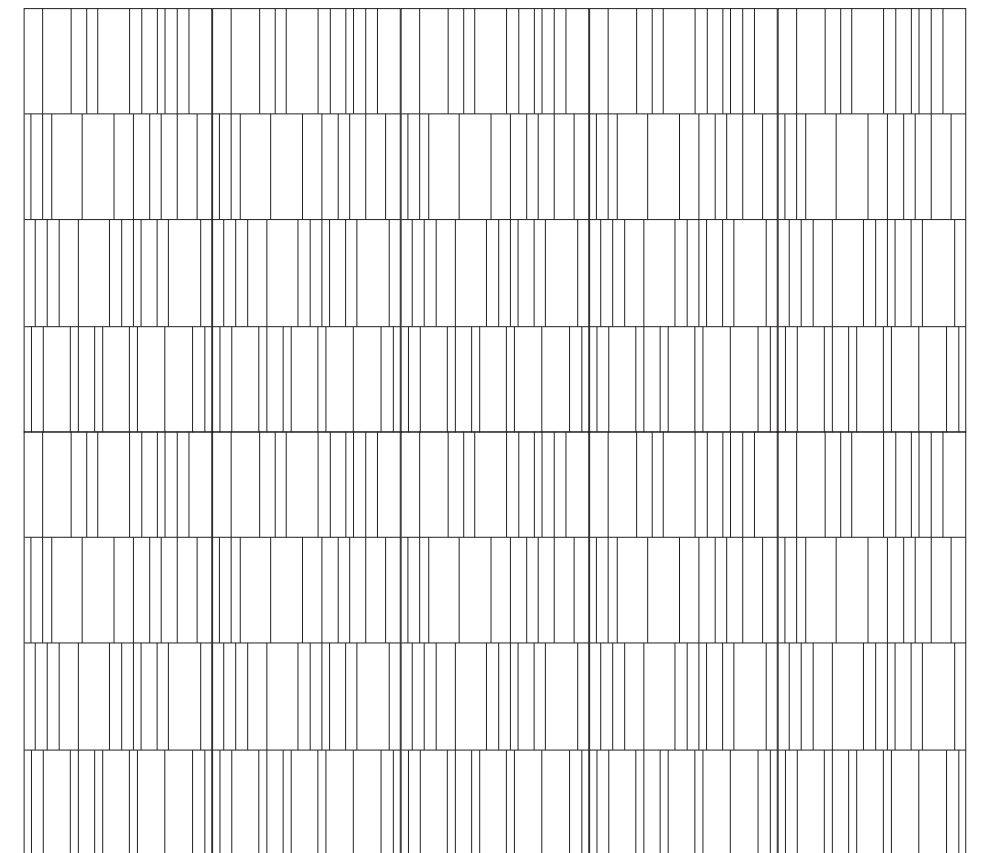

Layout 4

Dash Pattern

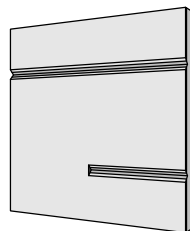
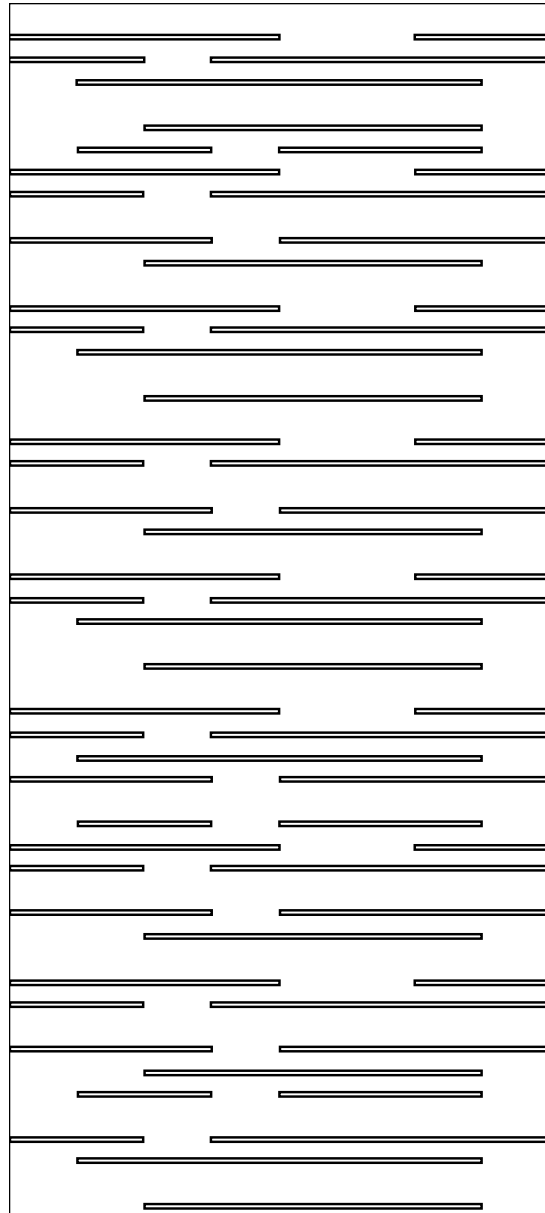

* Enlarged Detail

Recommended Layouts



Layout 1



Layout 2

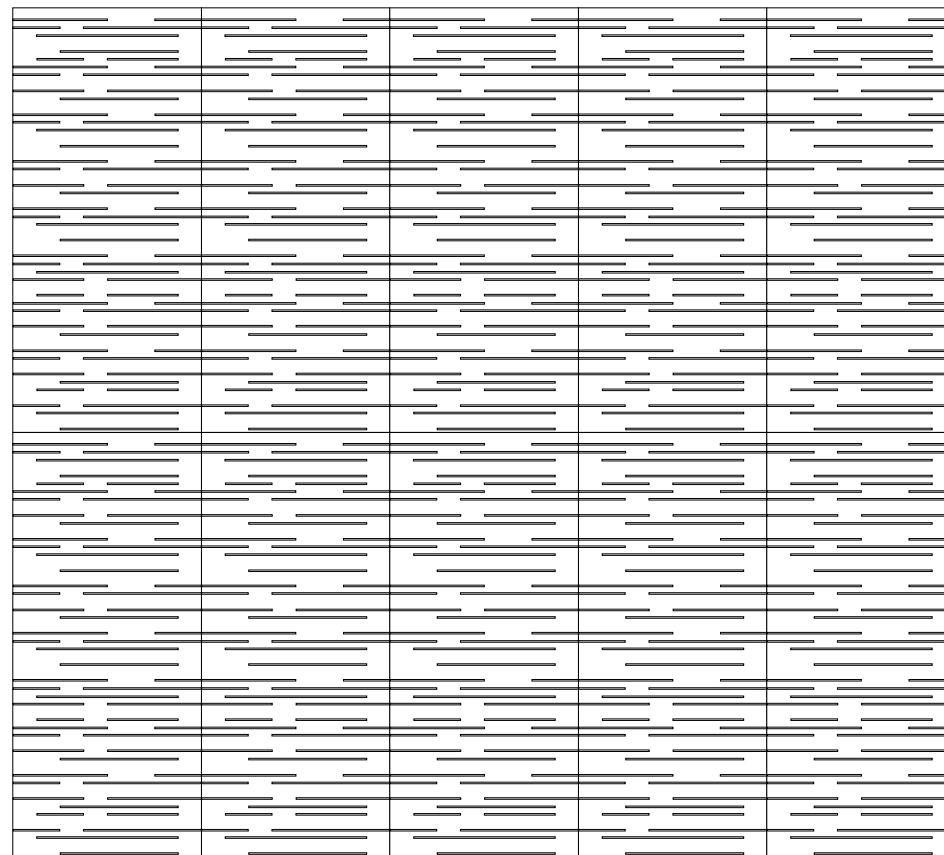

Layout 3

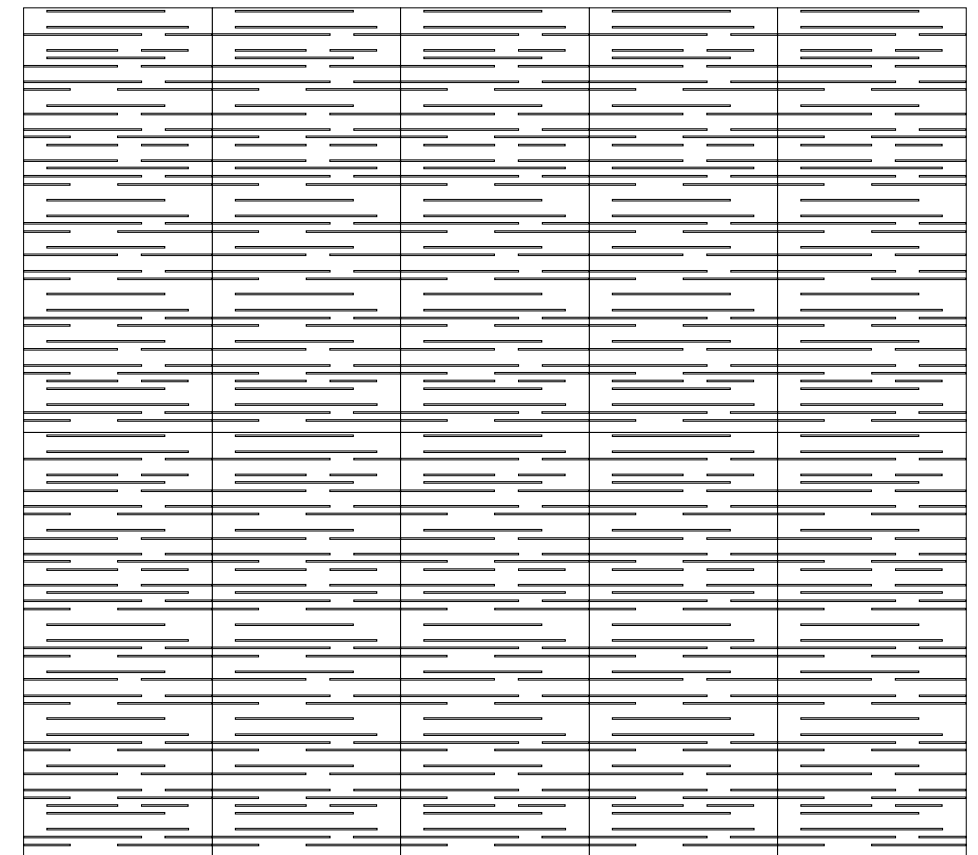

Layout 4

Fineline Pattern

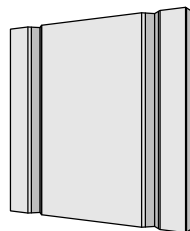
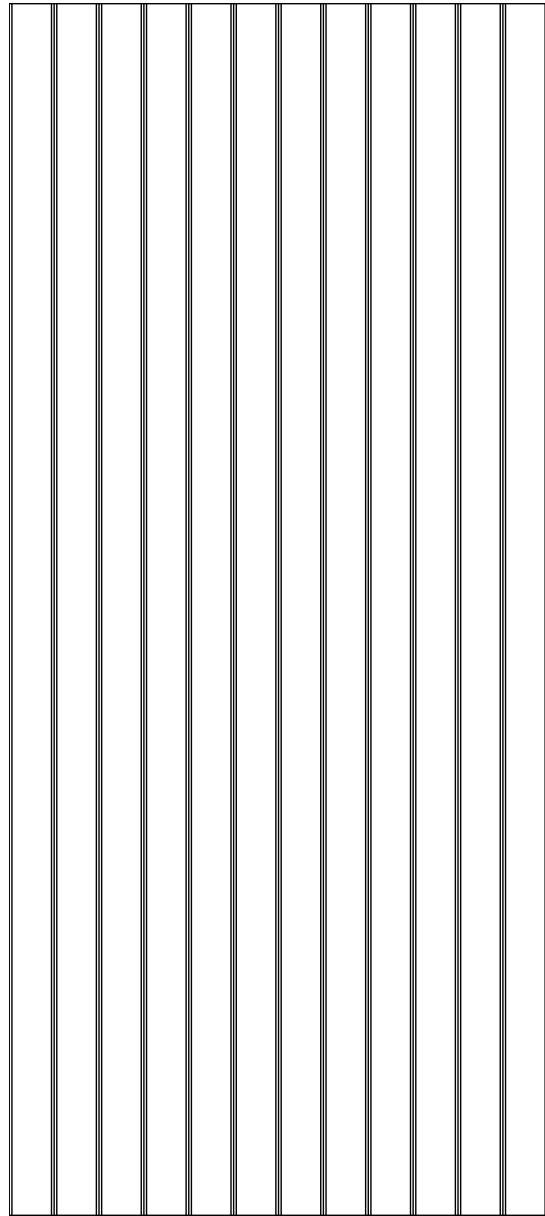

* Enlarged Detail

Recommended Layouts

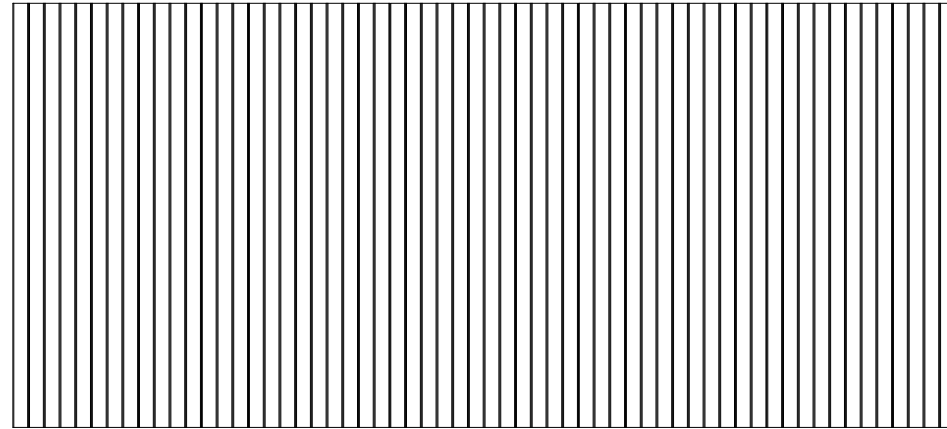

Layout 1

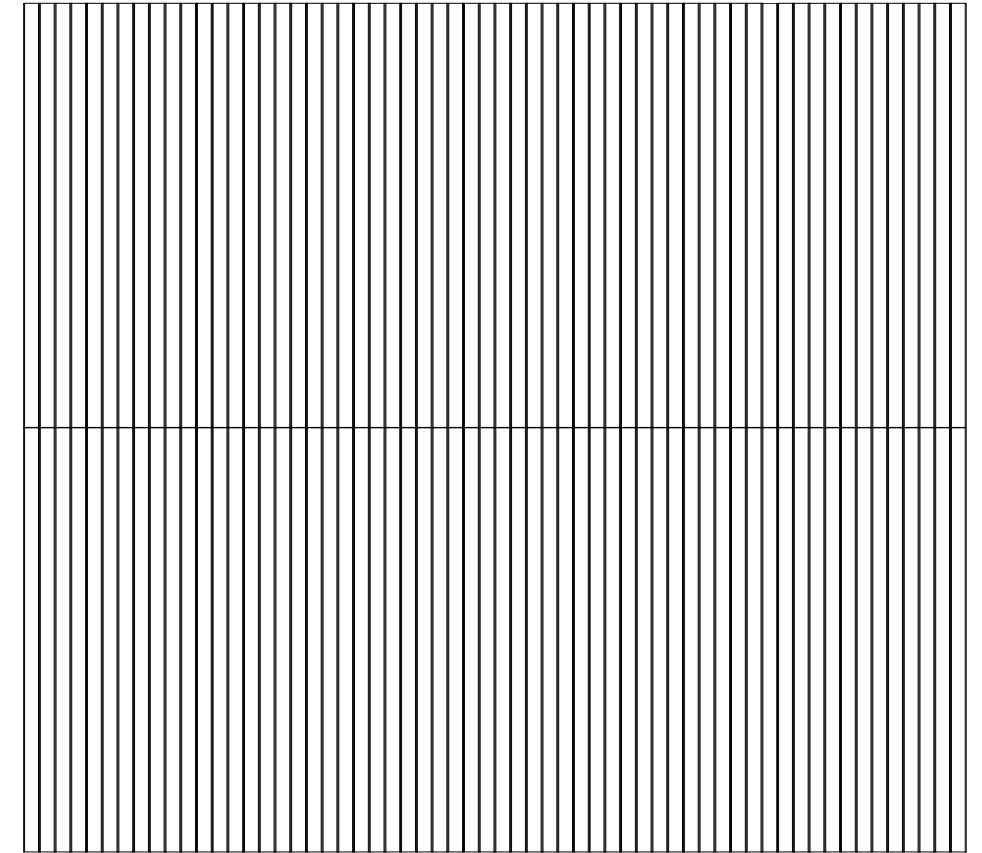

Layout 2

Optics Pattern

Recommended Layouts

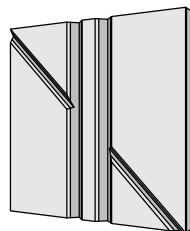
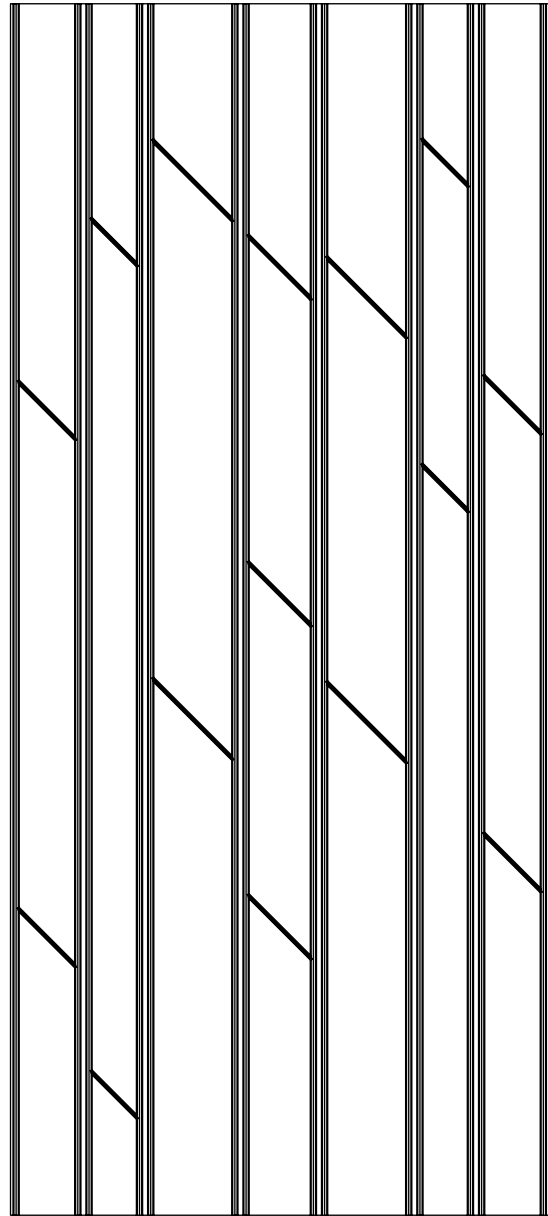

* Enlarged Detail

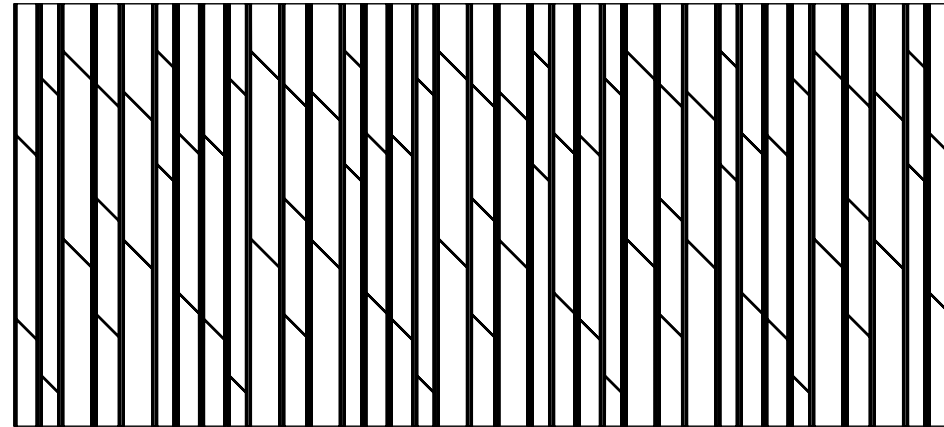

Layout 1

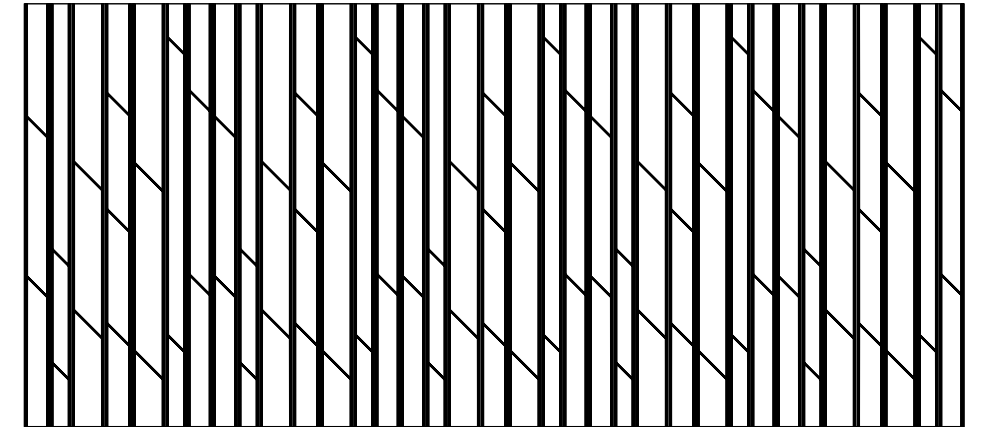

Layout 2

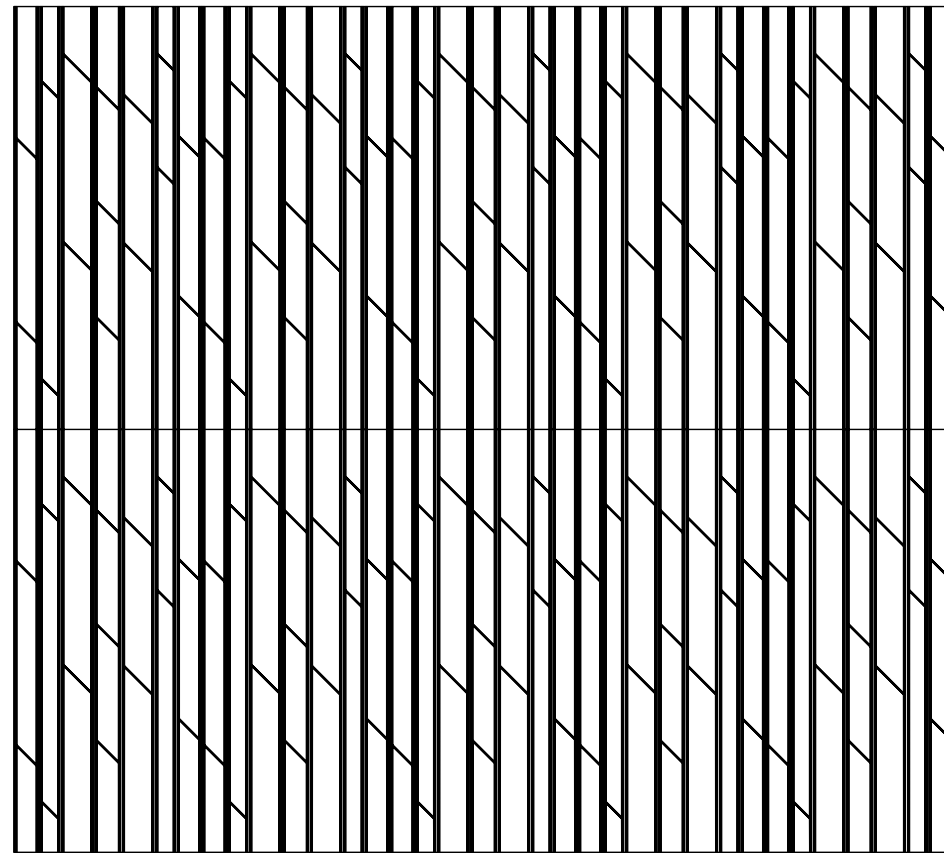

Layout 3

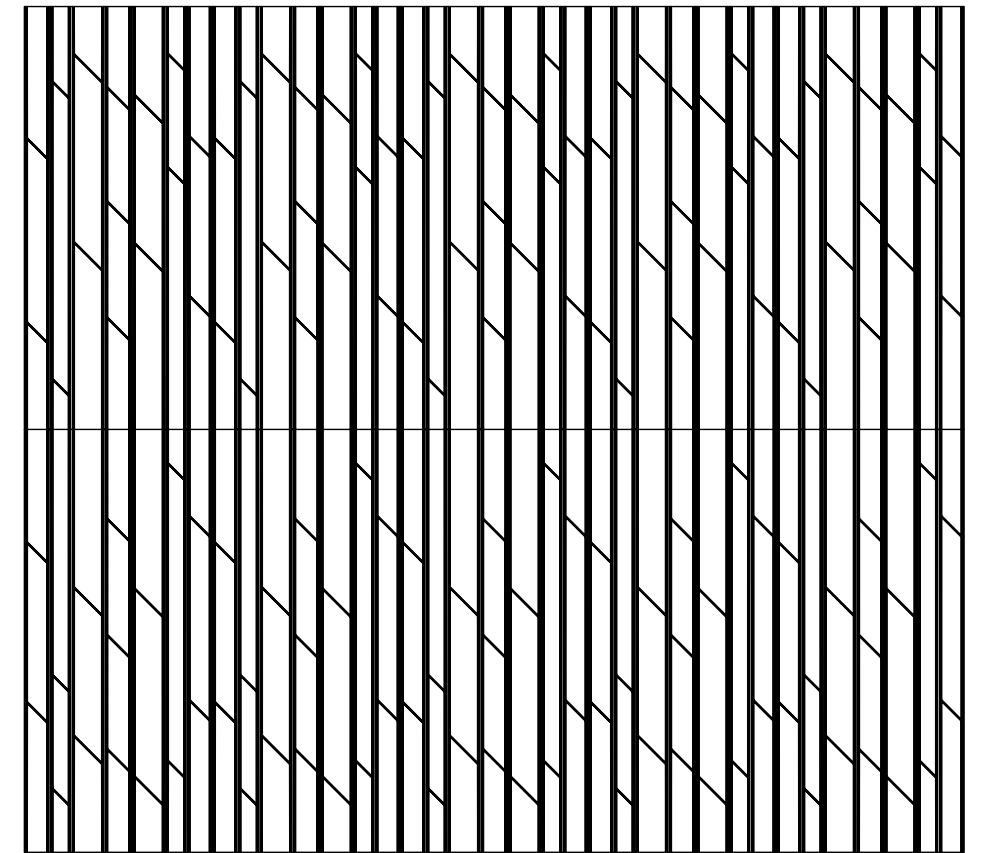

Layout 4

Parallax Pattern

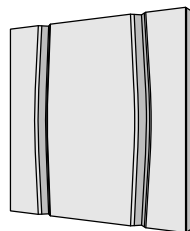
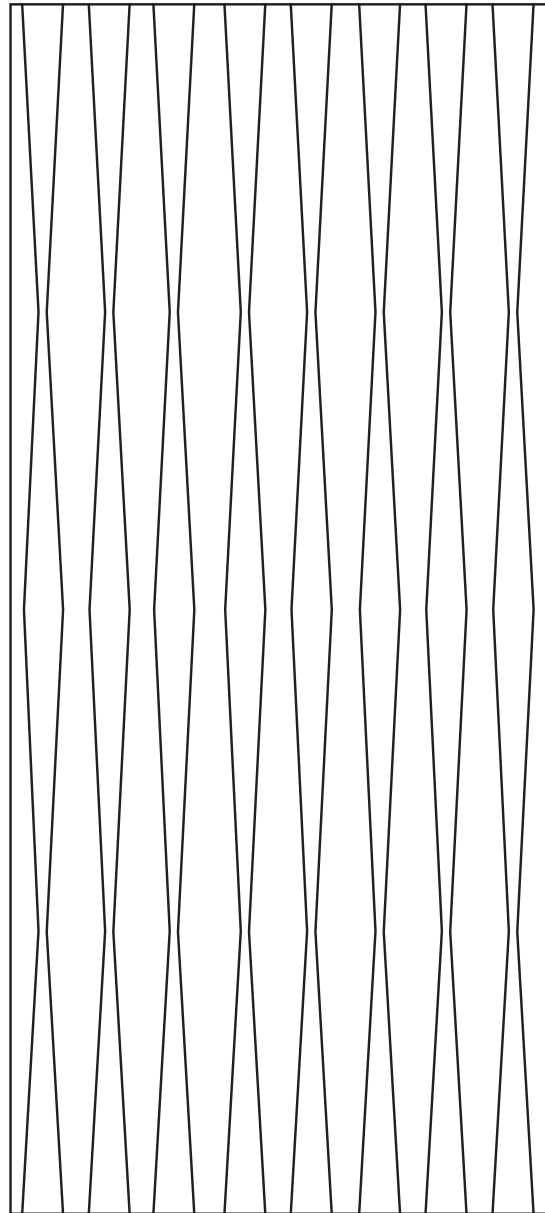

* Enlarged Detail

Recommended Layouts

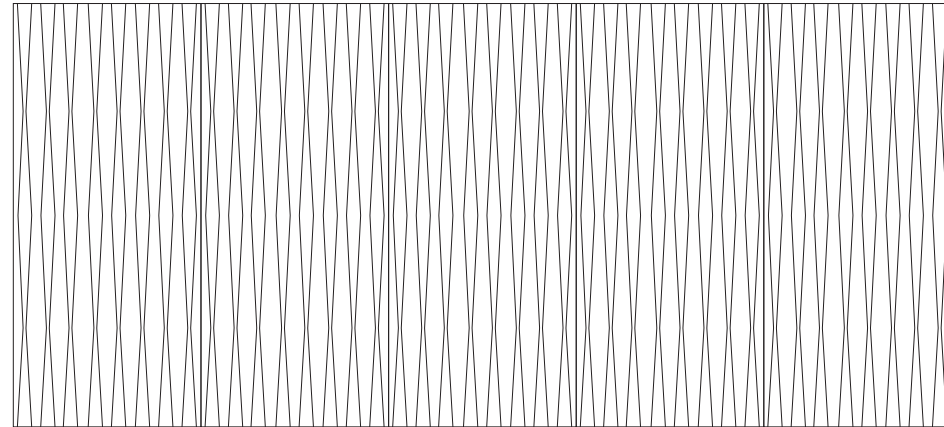

Layout 1

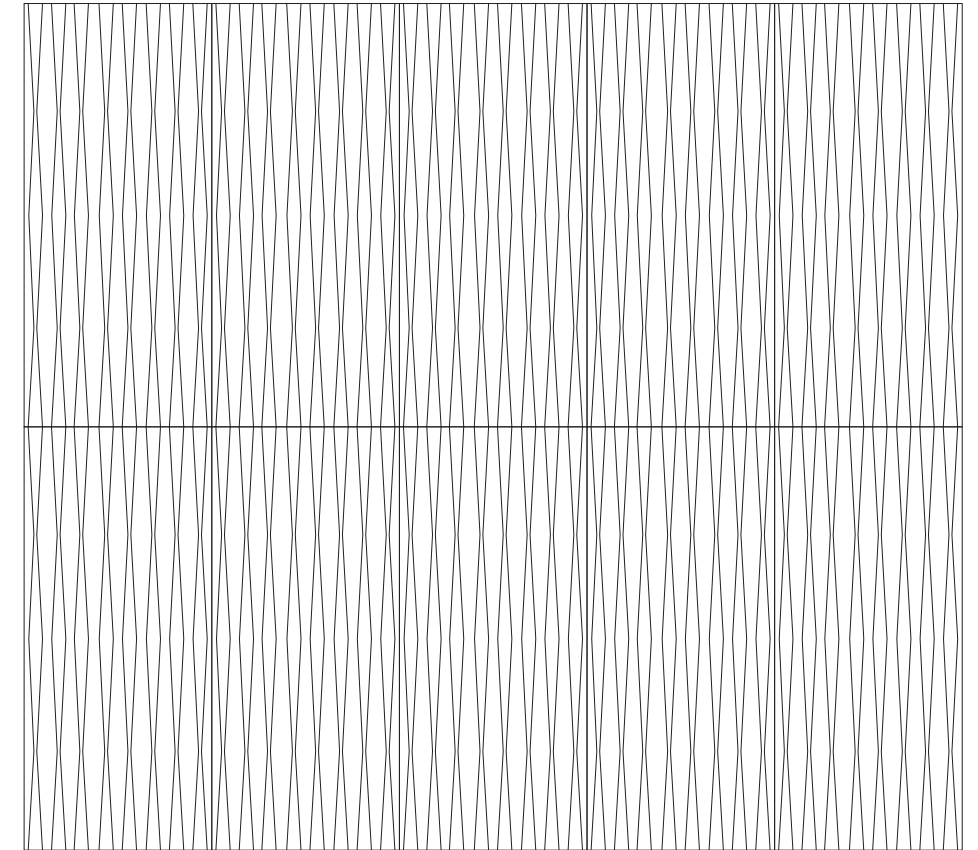

Layout 2

Raindrop Pattern

Recommended Layouts

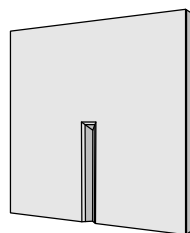
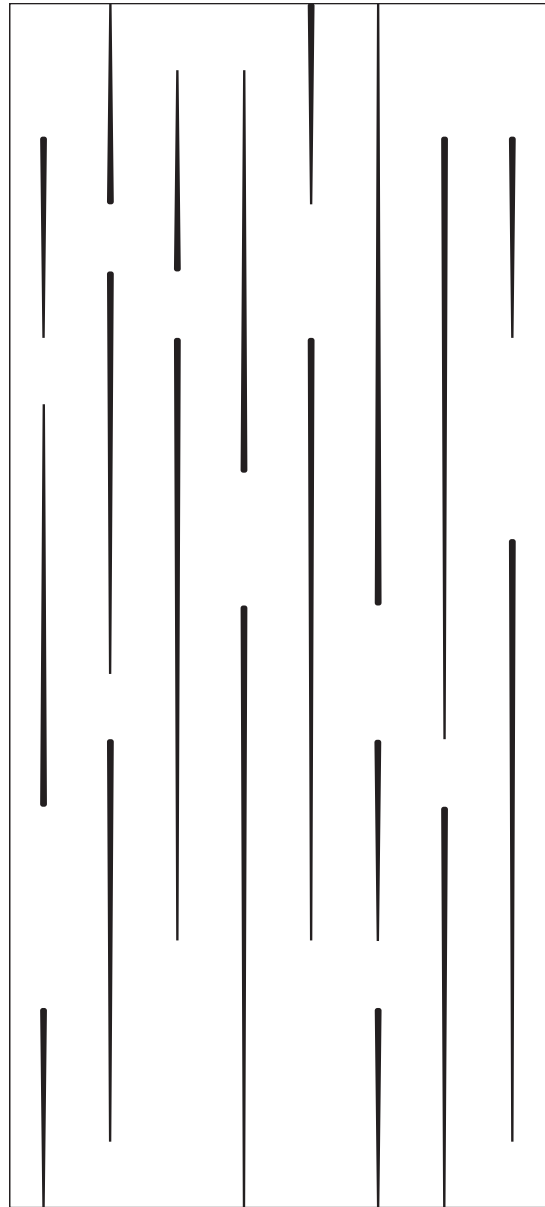

* Enlarged Detail

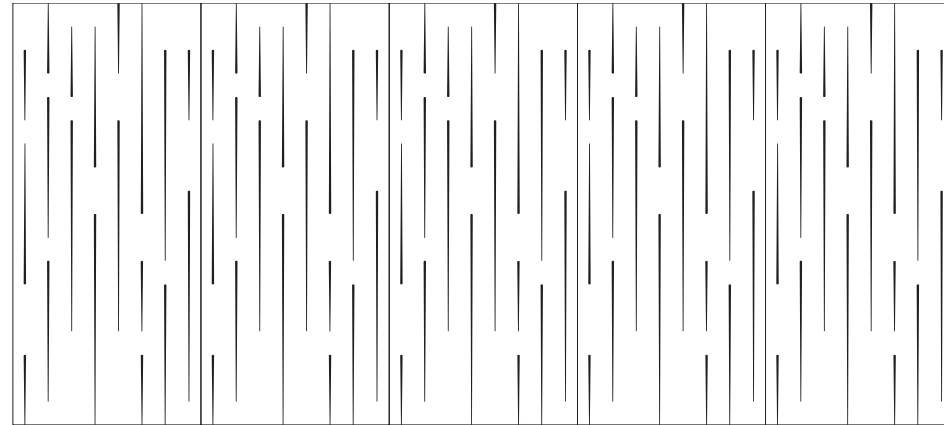

Layout 1

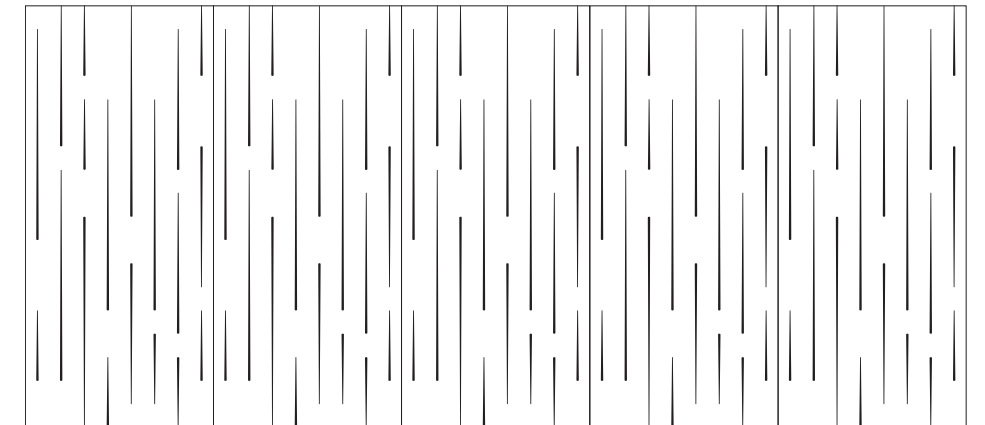

Layout 2

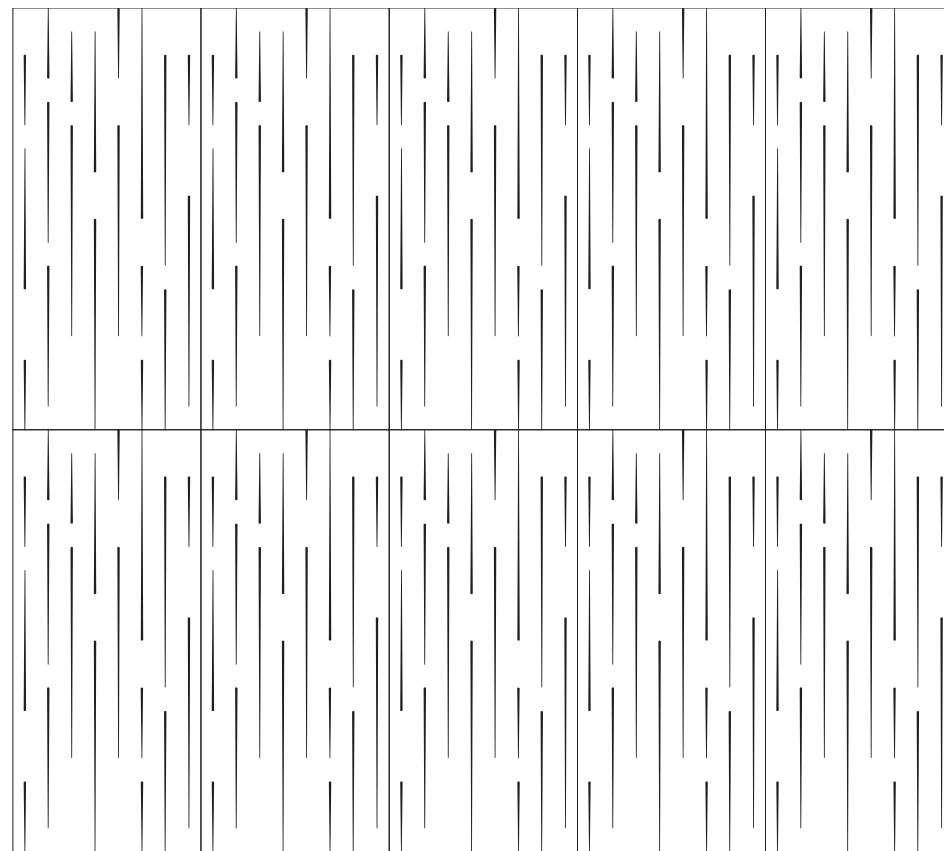

Layout 3

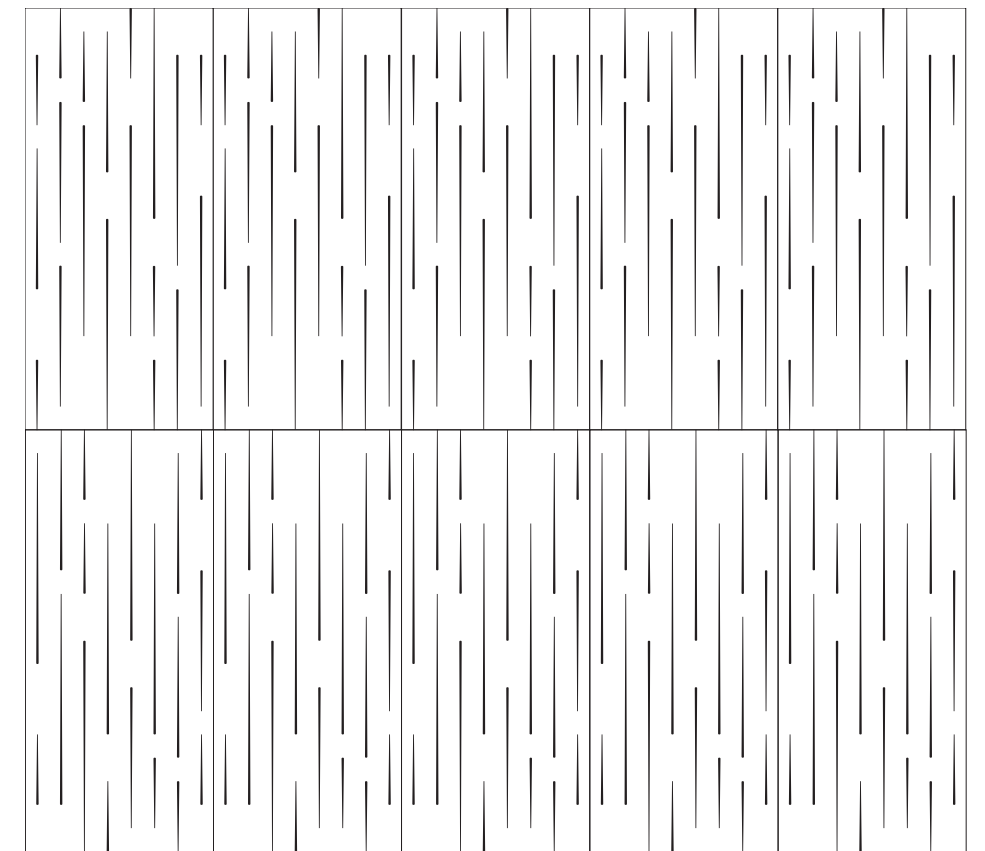

Layout 4

Shard Pattern

Recommended Layouts

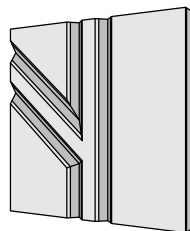
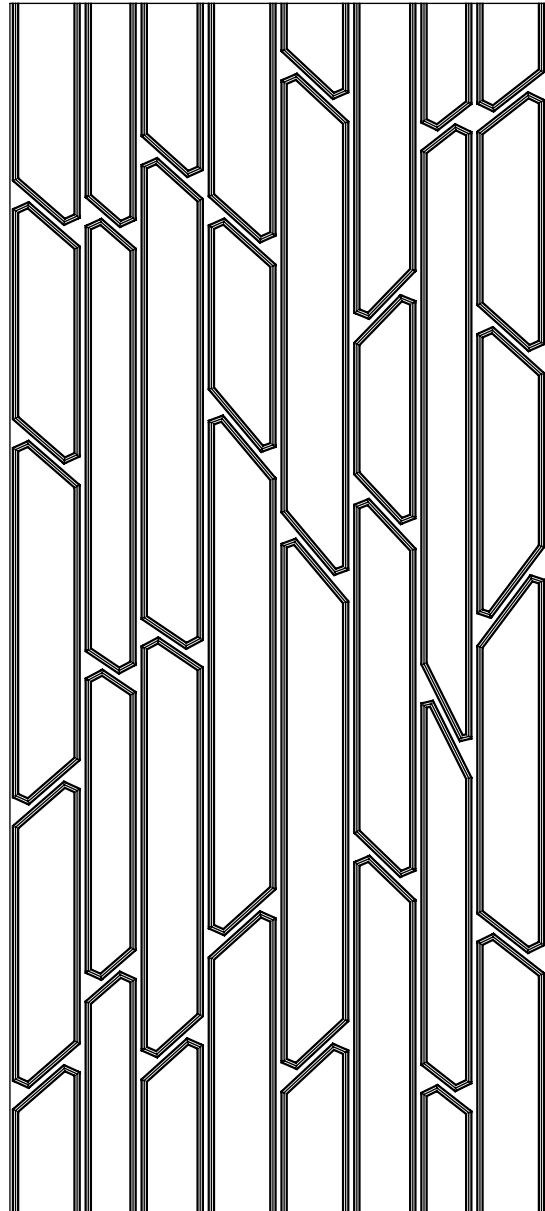

* Enlarged Detail

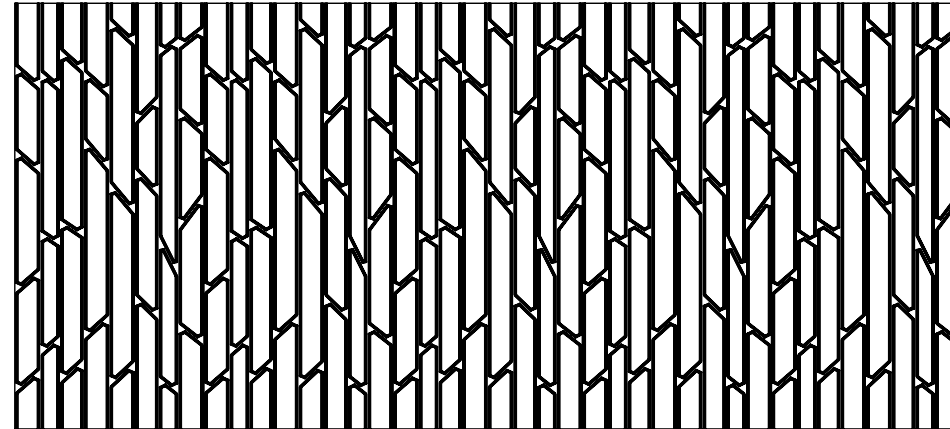

Layout 1

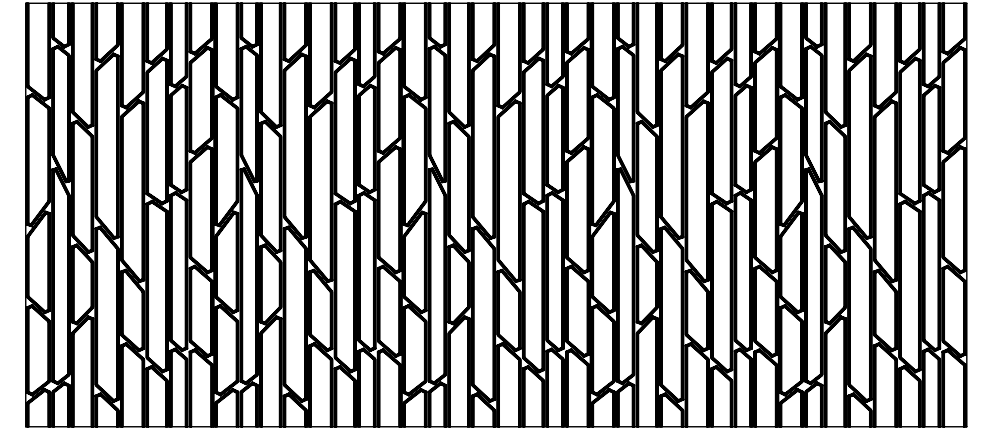

Layout 2

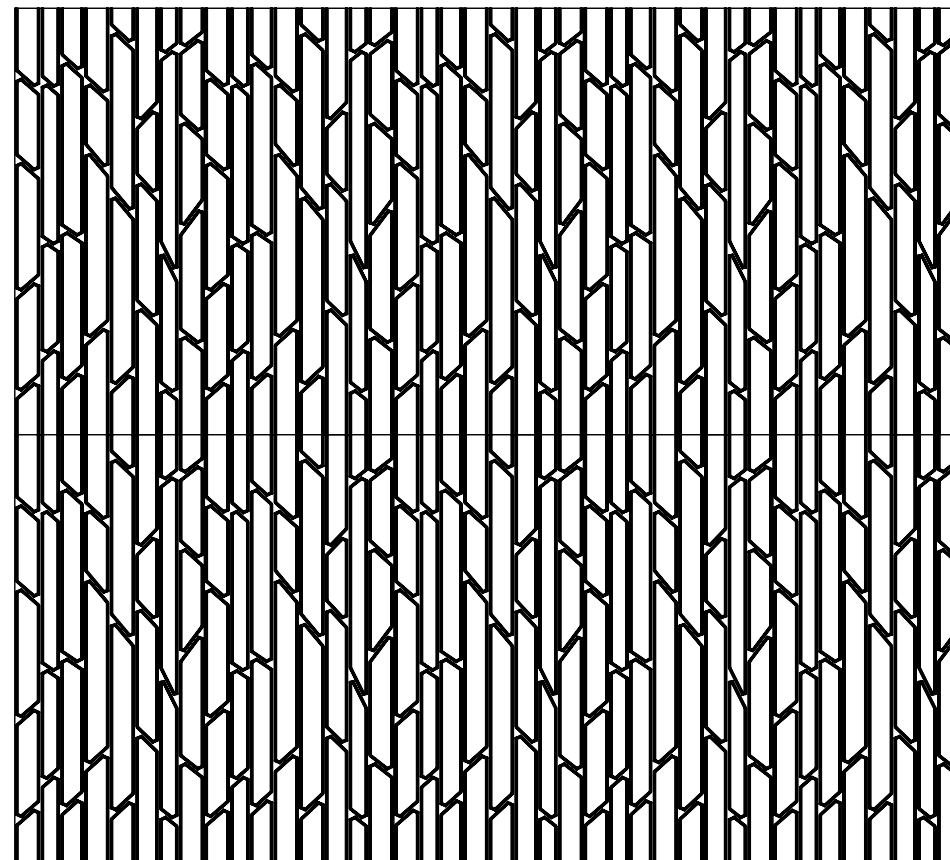

Layout 3

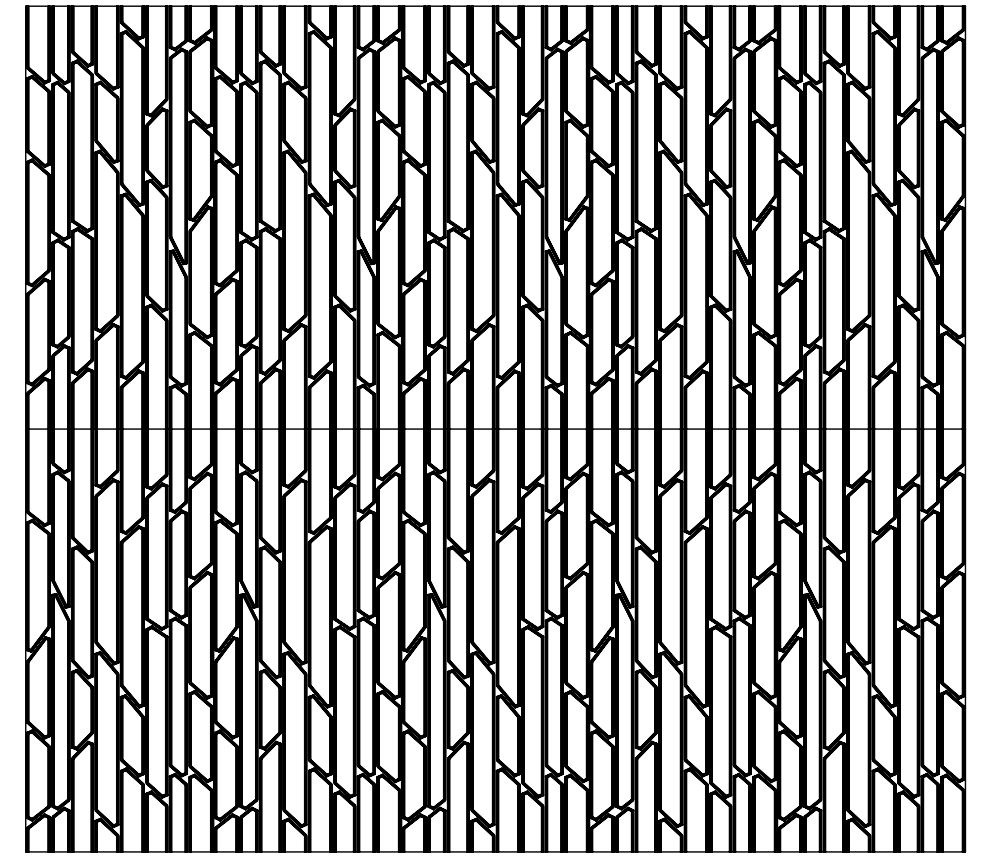

Layout 4

Smoke Pattern

Recommended Layouts

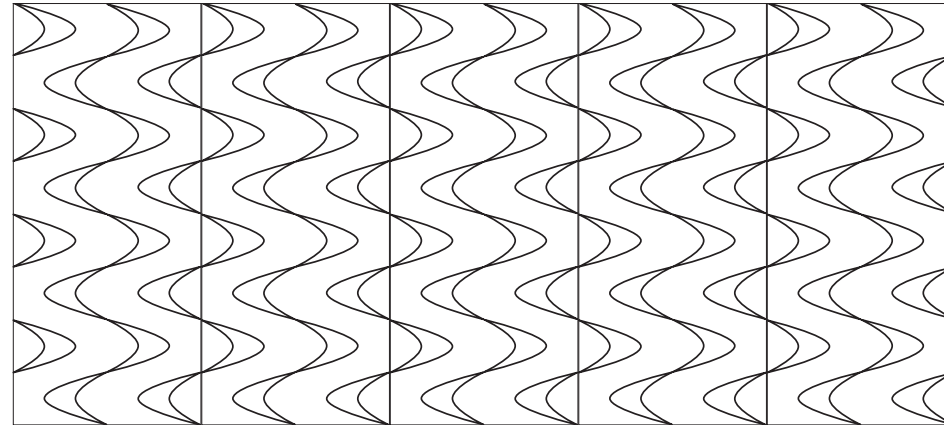
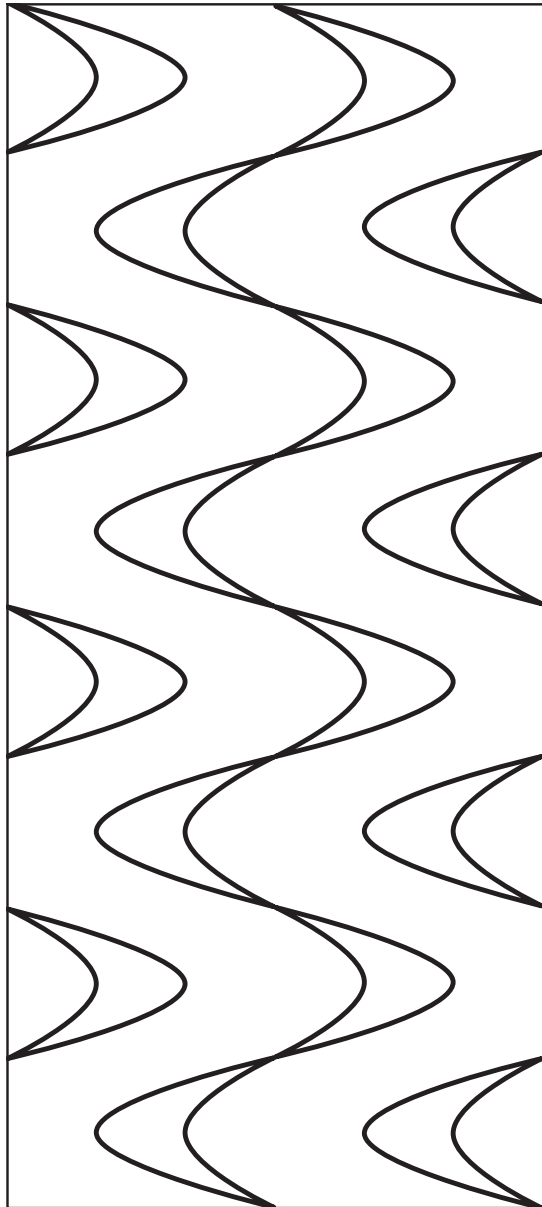

Layout 1

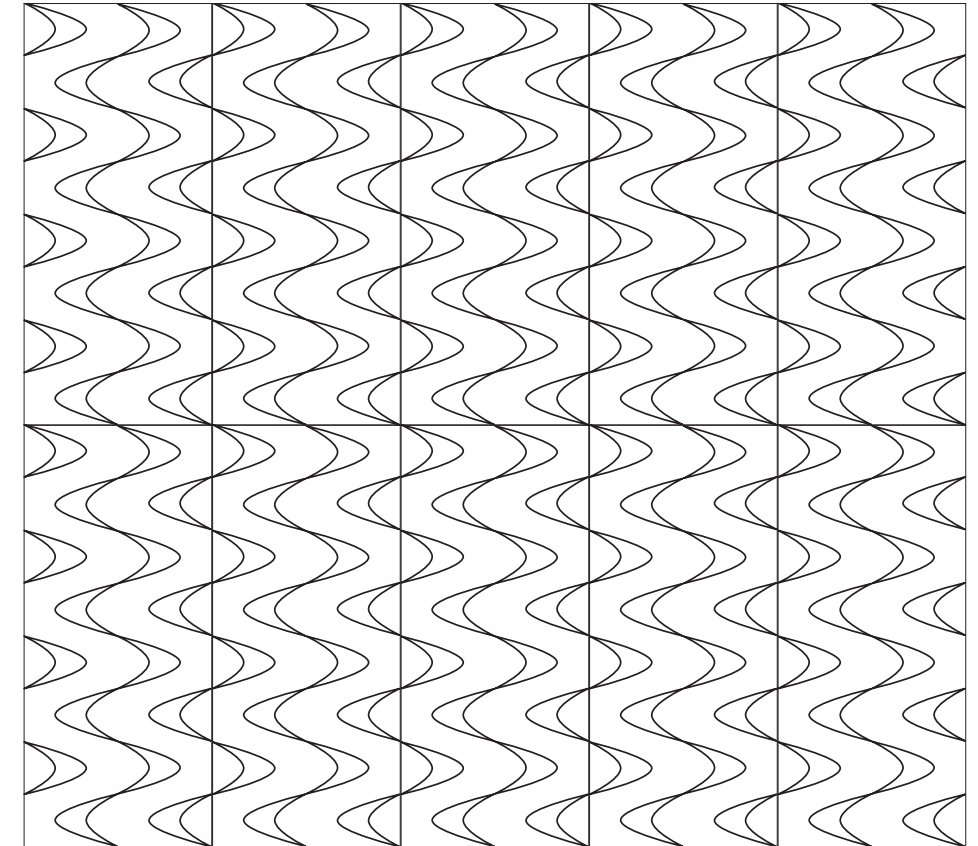

Layout 2

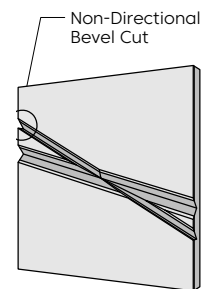

* Enlarged Detail

Disclaimer: Please ensure that all sheets are arranged in the same direction to avoid mismatching patterns. The central bevel is directional and must match all adjoining panels.

Thread Pattern

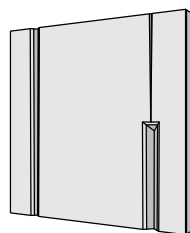
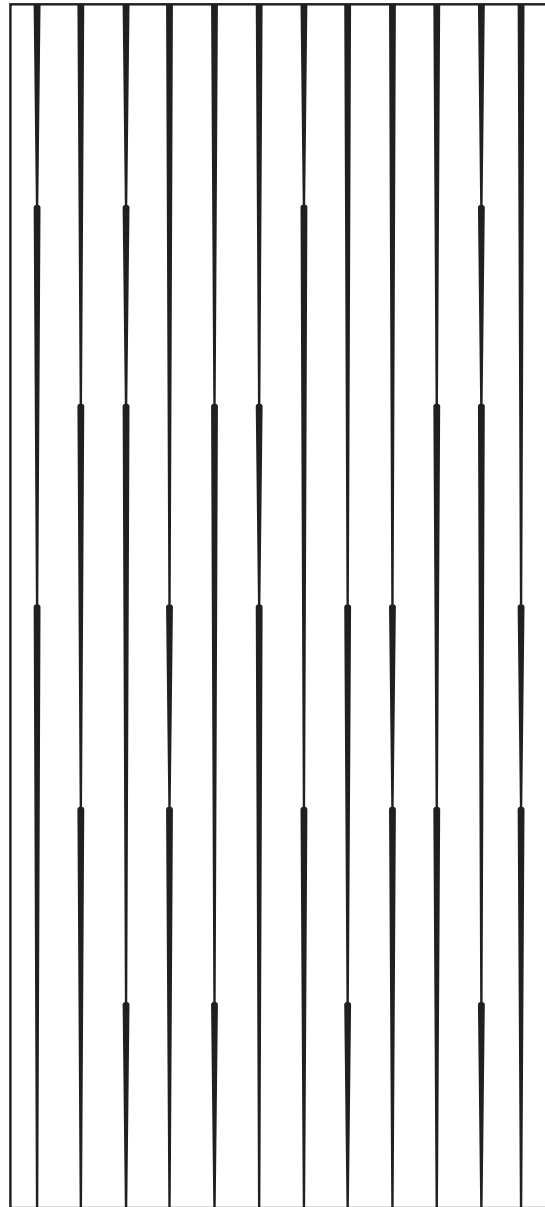

* Enlarged Detail

Recommended Layouts

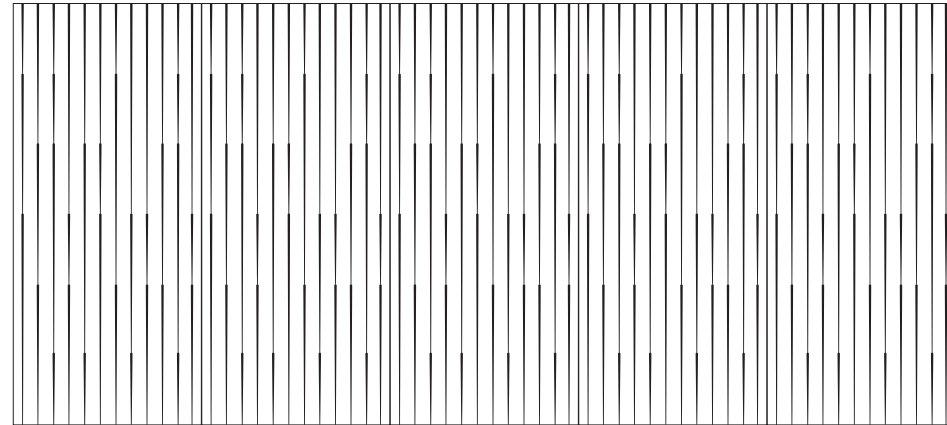

Layout 1

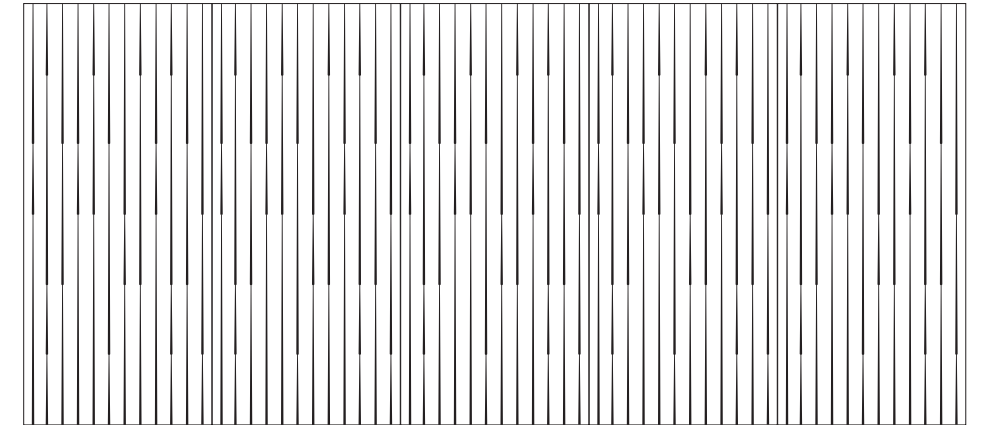

Layout 2

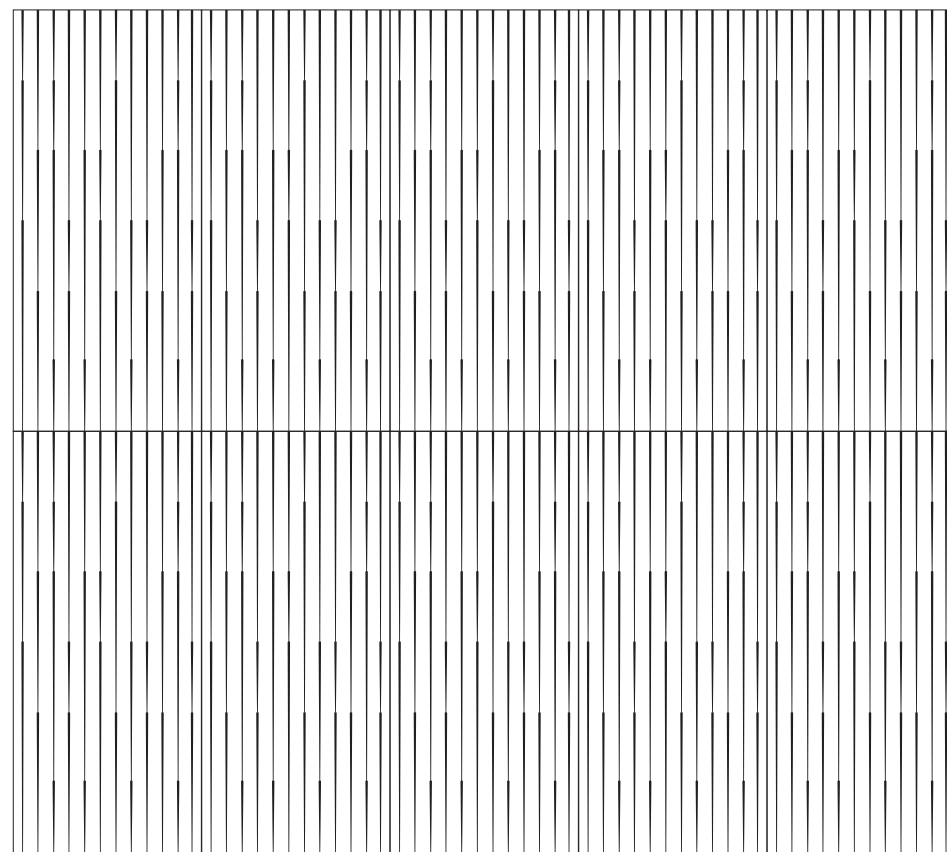

Layout 3

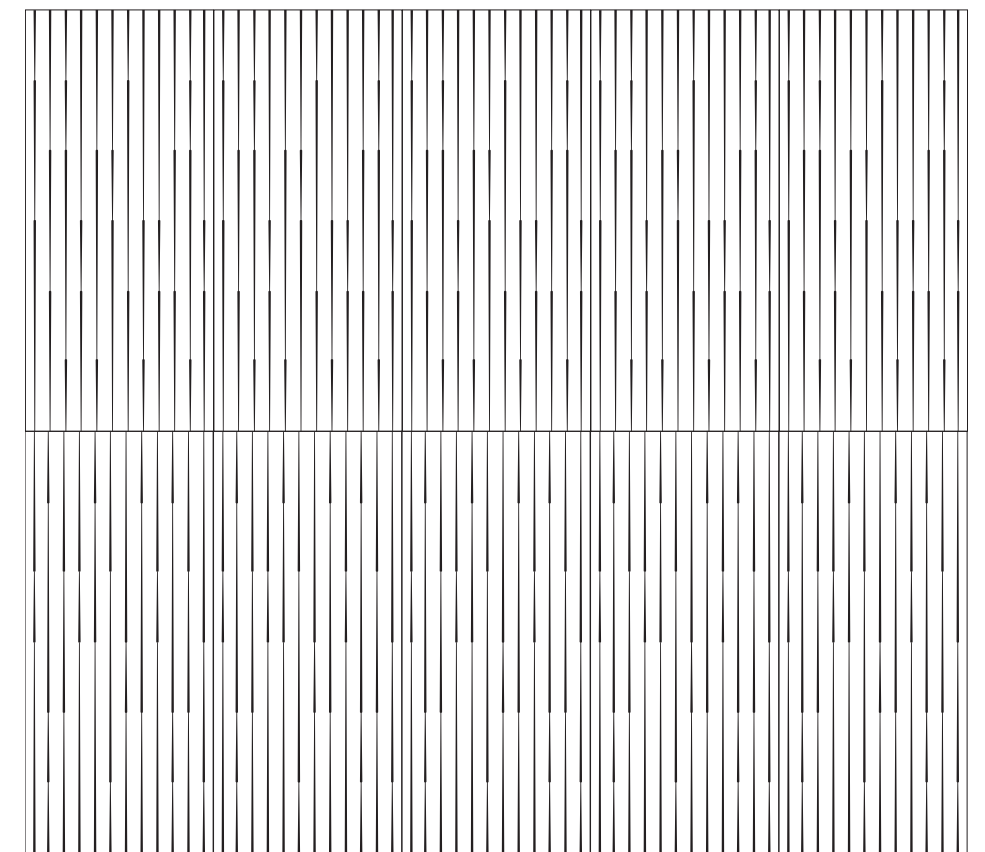

Layout 4

Vapor Pattern

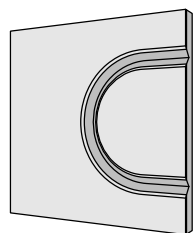
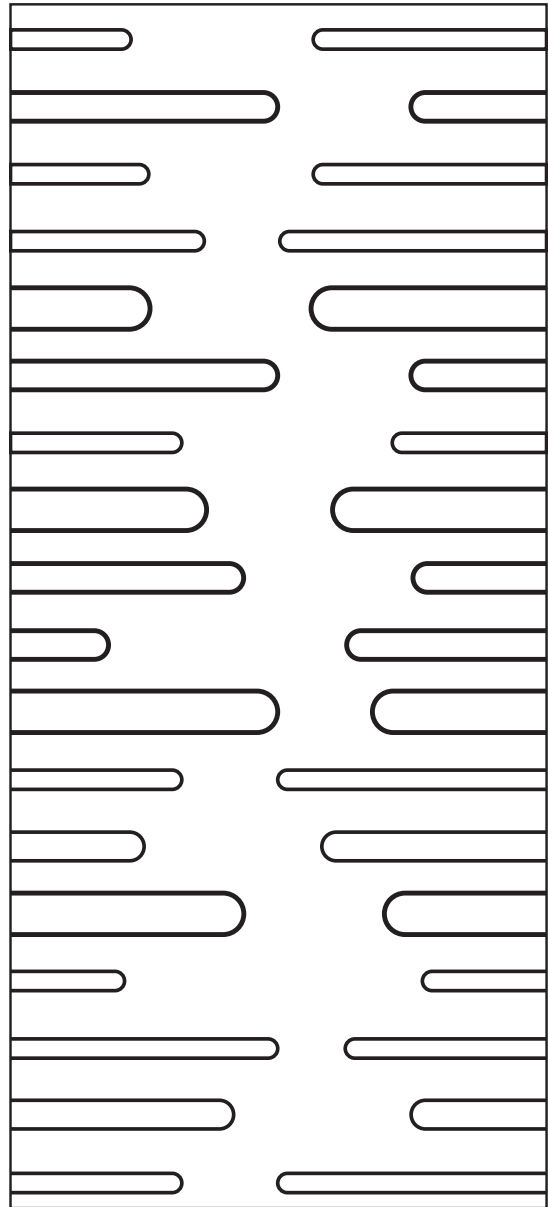

* Enlarged Detail

Recommended Layouts

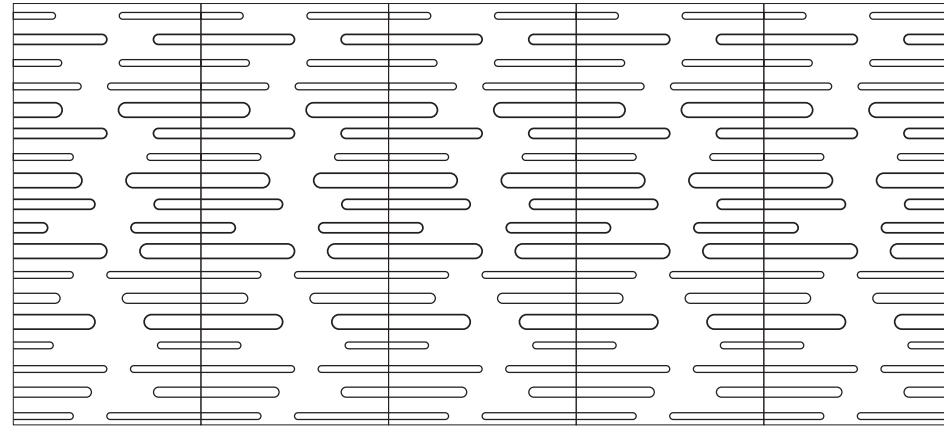

Layout 1

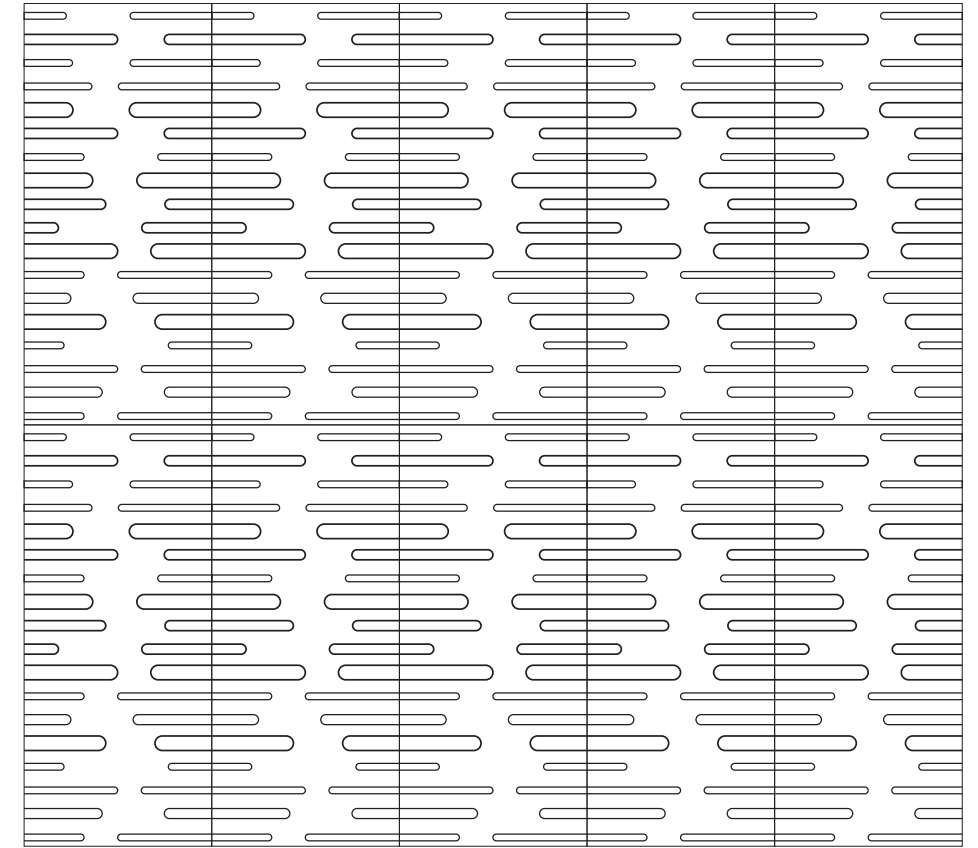

Layout 2

Colorways

Light Reflectance Values (LRV), are a measure of the percentage of visible and usable light that is reflected from a surface when illuminated by a light source.

										
Celery LRV - 43.64%	Flint LRV - 5.14%	Shiraz LRV - 3.99%	Quartz LRV - 36.85%	Peppercorn LRV - 8.50%	Currant LRV - 7.04%	Carrot LRV - 20.00%	Peach LRV - 29.00%	Flamingo LRV - 37.54%	Turmeric LRV - 29.59%	Popcorn LRV - 65.00%
										
Kale LRV - 4.50%	Oregano LRV - 8.80%	Thistle LRV - 13.00%	Wasabi LRV - 38.00%	Sencha LRV - 34.15%	Pistachio LRV - 30.00%	Midnight Blue LRV - 3.50%	Granite LRV - 6.40%	Denim LRV - 6.00%	Peacock LRV - 19.00%	Azur LRV - 18.00%
										
Marine LRV - 25.00%	Periwinkle LRV - 36.00%	Sea Salt LRV - 28.56%	Lilac LRV - 39.00%	Iris LRV - 10.50%	Berry LRV - 12.00%	Piano Black LRV - 3.00%	Charcoal LRV - 5.46%	Slate LRV - 12.50%	Grey LRV - 27.00%	Metal LRV - 35.00%
										
Platinum LRV - 42.00%	Walnut LRV - 12.14%	Umber LRV - 20.35%	Almond LRV - 53.64%	Ivory LRV - 40.00%	Pearl LRV - 54.00%	White LRV - 83.22%	Lipstick Red LRV - 12.50%	Butter LRV - 62.00%		

Color Scheme Examples

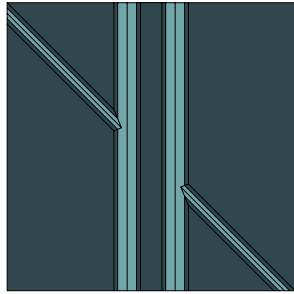

Demin (DE09)
+ Sea Salt (SE57)

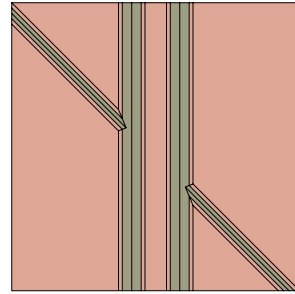

Flamingo (FL61)
+ Pistachio (PI25)

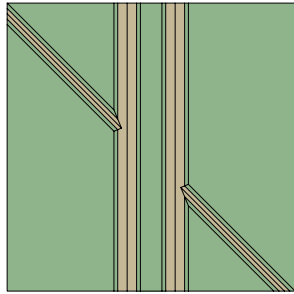

Sencha (SE58)
+ Ivory (IV11)

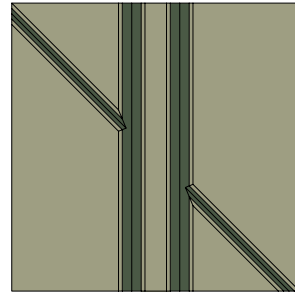

Pistachio (PI25)
+ Oregano (OR18)

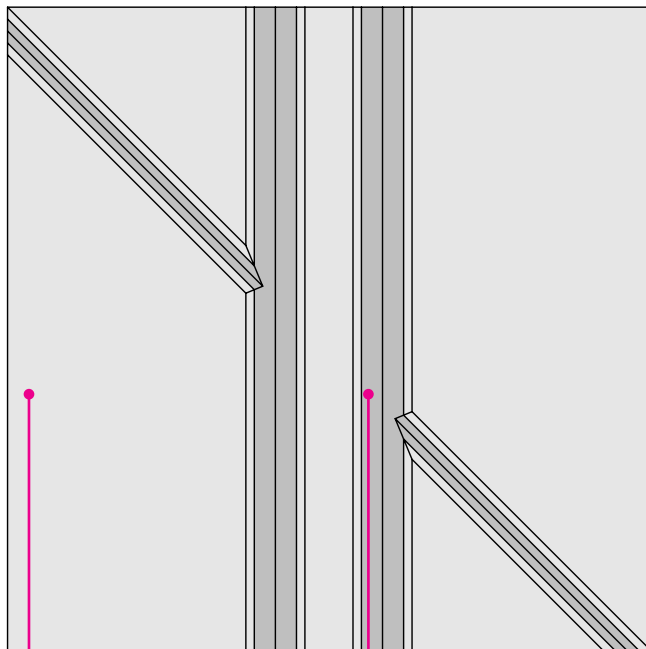

Backing panel color Skin color



Mounting Methods

Adhesive Backing

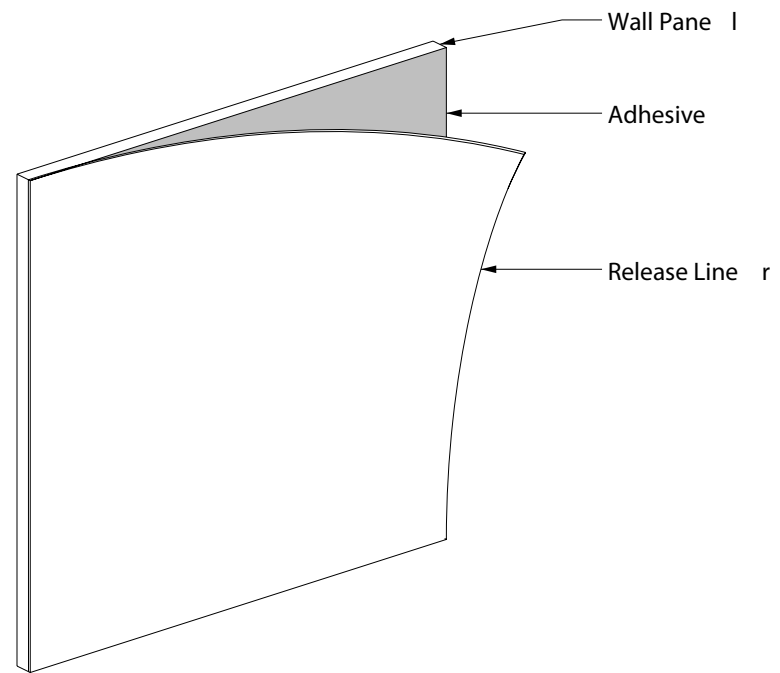

Constructive Adhesive

