

Bildspec Moove™ Acoustic Slider



The Bildspec Moove™ acoustic Slider has been designed, tested, and manufactured with the end user in mind. These sliding glass partitions will maximize your space, functionality and provide strong acoustic capabilities. Typically suited to areas that you wish to divide with a physical but not visual barrier and where medium sound control is a requirement. Well-suited for schools, offices, hospitals and more.

It is the only acoustic sliding door on the Australian market to incorporate different dampening pressures on the breaking system to suit the weight of the slider door. This means you can operate lighter sliders more easily but still have the safety of a strong baking system for heavier configurations.

Bildspec Moove™ builds on the success of our over 55 years' experience in the folding/sliding door industry, and like all our products is Australian designed and manufactured. Almost unlimited variations in track and panel configuration and finish options, together with our manufacturing flexibility, allow you to have the system that is right for your project.

General

The operable wall shall be specified as The Bildspec Moove, sliding acoustic walls shall be installed by an authorised representative of the manufacturer and shall be an aluminium-framed glass-panel partition system, operating in a sequential manner of top-supported, manually operated panels that can be linked together to form a sound retardant closure. Glass is supplied in accordance with the Australian Standard: AS1288 Glass selection in Buildings.

Panels

Bildspec's new Moove System also incorporates one of the smallest frames on the market to maximise light and the aesthetics of a glass system in its environment.

The Moove can achieve a maximum width of 3.6m for a single sliding door (3 panels) or 7.2m for a bi-parting slider (6 panels). Maximum achievable height is 3m. Maximum panel width of 1.5m facilitating wide, clear views.

The Rw 30 Slider Panel weight is 21kg per Square Metre with a 6.3mm laminated glass finish. Please enquire for other finishes.

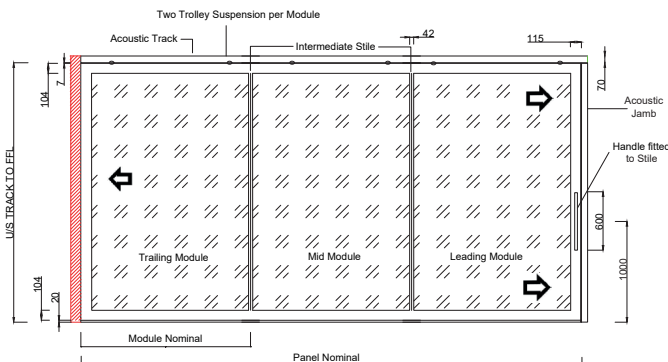

Standard Configuration

Glass		6.38mm Laminated 30 RW		8.5mm Hush Laminated 33 RW		10.38mm Laminated 34 RW	
Height		Up to 3m		Up to 3m		Up to 3m	
Maximum Width	Fully Framed (1 module)	Up to 1.2m wide	Max 3m ² area	Up to 1.5m wide	3m high	Up to 1.5m wide	3m high
	Framed modules	Up to 2.4m wide	Max 6m ² area	Up to 2.4m wide	3m high	Up to 2.4m wide	3m high
	Framed (3 modules)	Up to 3.6m wide	Max 9m ² area	Up to 3.6m wide	3m high	Up to 3.6m wide	3m high

Maximum 3 modules to a panel

All of Bildspec sliders meets DDA opening force requirements

Acoustic Performance

With rigorous acoustic testing at the new, large format facility at UTS in Sydney, we were able to achieve certified results of Rw30, Rw33, and Rw34 acoustic performance – enough to meet most acoustic specifications. The weights of these system are as follows:

Rw30 – 21 kg Per Sqm

Rw33 – 25kg Per Sqm

Rw34 - 29kg Per Sqm

Top Track

These sliding partition glass doors offer effortless movement without any floor tracks. This slider includes a special track and trolley system uniquely designed for this product, which translates into a system that is not only quiet, but glides effortlessly across its opening. The Moove panels slide in a sequential movement, with overlapping vertical stiles, and interlocking top and bottom. No bottom track required. An opening force of 20 Nm or less is required to operate the first panel.

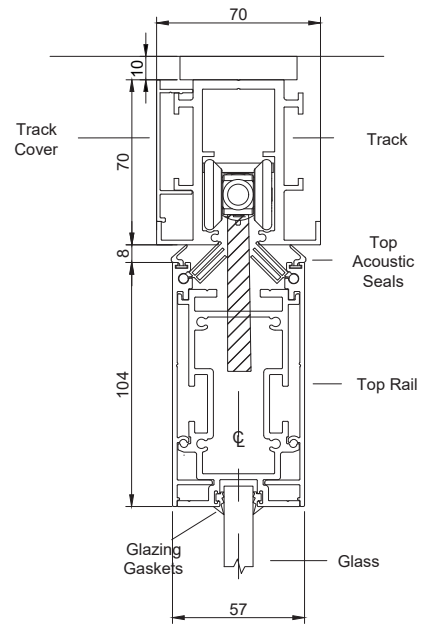

Closure System

The lead panel soft close for slam reduction A.S.S (Anti Slam System), reduced maintenance, and reduced closing force. Rigorously tested and reduces operational noise.

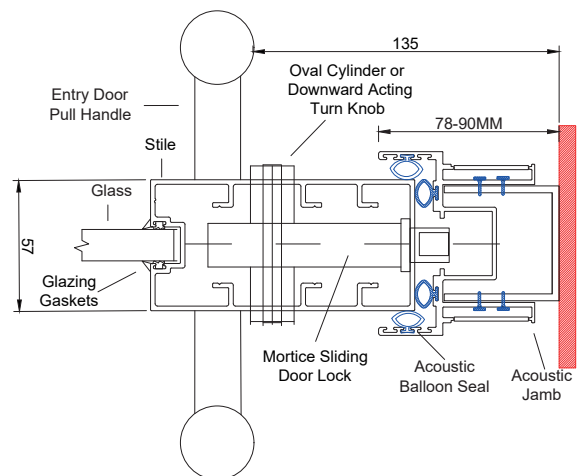

Panel Materials / Surfaces

Frame finishes are either natural anodised or powder coated as required. Panel infill materials offered in laminated glass plus many other infill possibilities to enhance visibility and style, while balancing visual privacy needs.

Safe Load Certification

Bildspec, in conjunction with a testing lab, performed a variety of pull tests on their complete systems to ascertain the maximum failure load of their track and trolley systems when installed.

Using a 200kN testing machine, we loaded the systems up at 5mm/min to produce analytical graphs for our consulting engineers to calculate the SWL for our complete installed system.

The engineers calculated the SWL using factors of safety and in conjunction with AS/NZS 1170.0 - 2002/ Amdt 2011 Structural Design Actions - Part: 0 general principles, and AS/NZS 1170.1 - 2002/ Amdt 2011 Structural Design Actions - Part: 1, permanent, imposed, and other actions.

Bildspec completed this certification to make sure our systems were fit for purpose and will perform correctly every day of the year.

Stacking / Configuration

Available in single, dual, or bi-parting configurations. Doors can run wall to wall, storage cavity to storage cavity, and wall overlap.

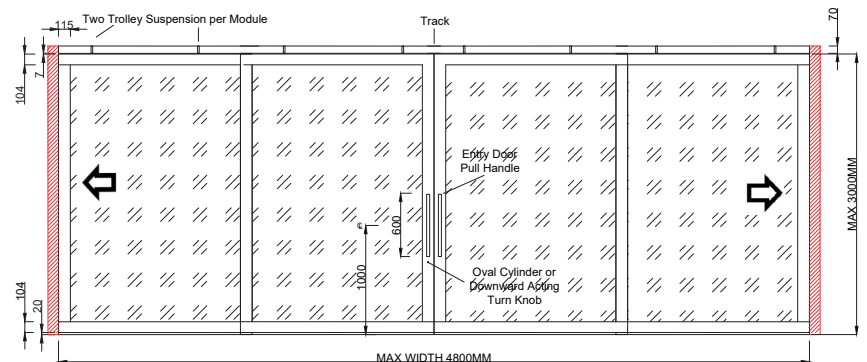
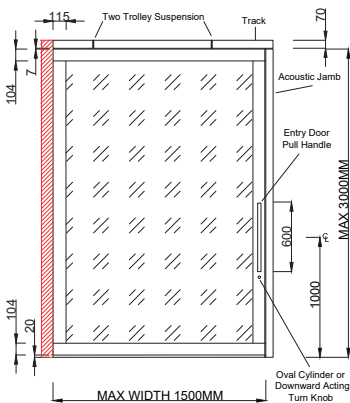
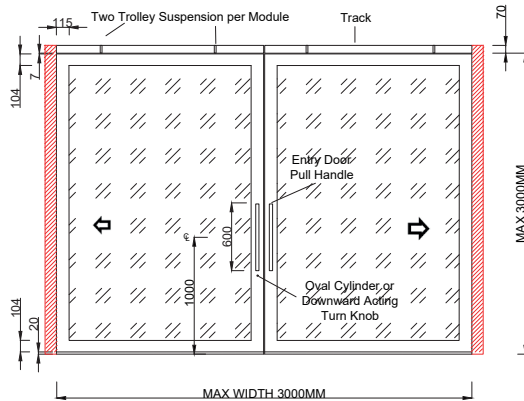
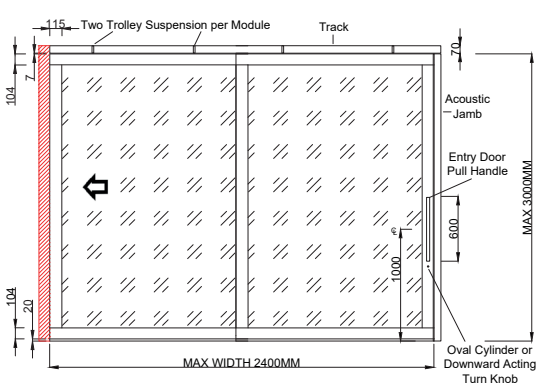

Hardware Options

Include D-handles, flush-pull and snib lever action and locking.

Locking options including Flush/Latch, Lever/Latch, or Foot bolt. Locking provided at waist level to assist with security and ease of use. Bildspec can offer BCA-compliant options for accessibility, using a lever activated snib cylinder.

Warranty

Bildspec operable walls shall be warranted against defect in materials and work for 12 months from installation.

Typical Applications

Typically suited to areas that you wish to divide with a physical but not visual barrier and where medium sound control is a requirement. These sliding glass partitions will maximize your space, functionality and provide effective acoustic performance. Well-suited for schools, offices, hospitals and more.

Benefits

- Creating flexible, adaptable spaces
- Creating attractive, open-plan environments
- Reduces noise transmission and reverberation
- DDA-compliant
- Easy to use

What Sets BILDSPEC Apart

We are proud to be your first choice for operable walls. When you work with our company, you can expect nothing less than the following:

- We deliver on time
- High quality at great value
- Average of 8 years industry experience per employee
- We are customer service focused
- We offer technical expertise
- We provide fit-for-purpose acoustic solutions to the built environment with the end users experience front of mind
- We enjoy our work.
- Safety First – with everything we do



Sydney

V5, 391 Park Road, Regents Park
1300 967 672

Brisbane/Gold Coast

1300 967 672
QBCC Lic: 15392521
1300 838 259

ACT

1300 967 672

Melbourne

1300 967 672

South Australia

1300 967 672