



SOLIDAL® PMP
Perforated Metal Pressed Screens
U2-125 Details

INDEX:

U2-125

U2-125 Vertical Joint Detail	1
U2-125 External Corner Detail	2
U2-125 Internal Corner Detail	3
Module Perforation Detail	4

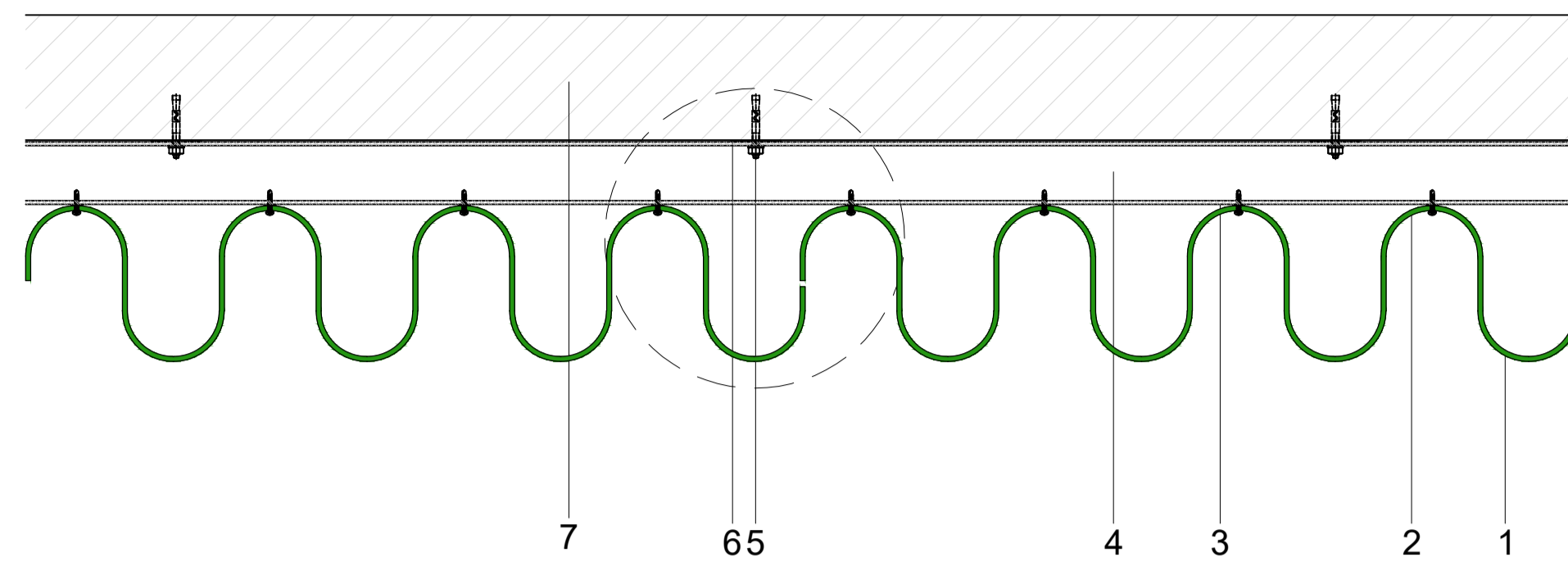

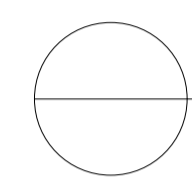
PMP U2-125 Vertical Joint
 1 : 1

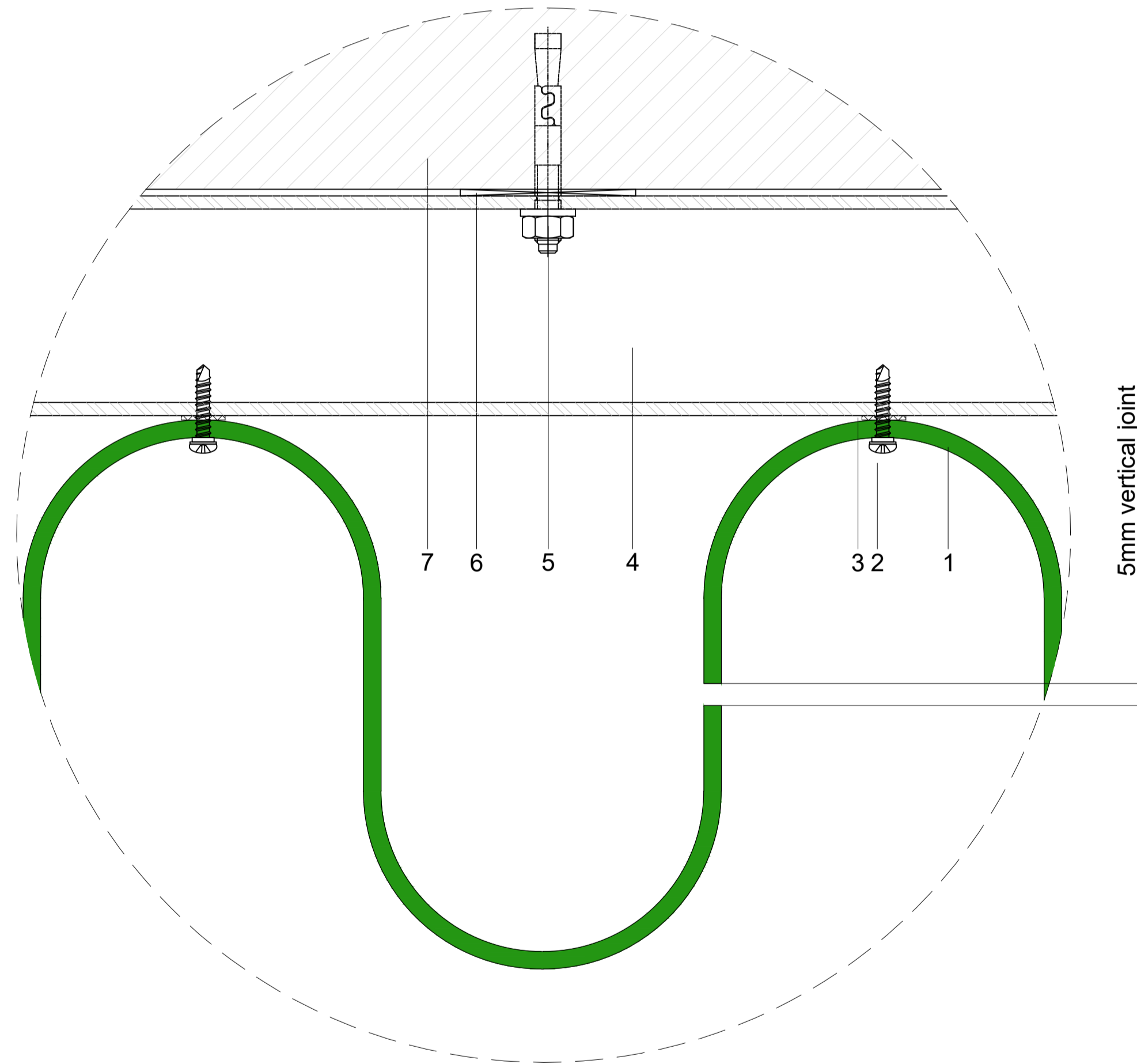

SOLIDAL® PMP U2-125
 Perforated Metal Pressed
 Vertical Joint - Typical Detail

- 1 SOLIDAL® PMP T2® | T3® | T4®
- 2 S/S Metal Tek screw w/ EPDM Gasket
- 3 Isolation Barrier
- 4 Powder Coated RHS Support Frame
- 5 Anchor Bolt
- 6 Packing as required
- 7 Building Structure

PMP U2-125 Vertical Joint Detail
 1 : 5

NOTE:
All design related drawings and concepts are property of SOLIDAL®.
Protected under Copyright Law.

PAGE:
1

DWG NAME:
SOLIDAL® PMP U2-125
Vertical Joint Detail

SCALE:
1:1 & 1:5 @ A1
DATE:
21 / JUN / 2023

PMP
SOLIDAL®

SOLIDAL® PMP U2-125
Perforated Metal Pressed
External Corner 90° Detail

- 1 SOLIDAL® PMP T2®|T3®|T4®
- 2 S/S Metal Tek screw w/ EPDM Gasket
- 3 Isolation Barrier
- 4 Powder Coated RHS Support Frame
- 5 Anchor Bolt
- 6 Packing as required
- 7 Building Structure
- 8 SOLIDAL® PMP EC (External Corner) Module

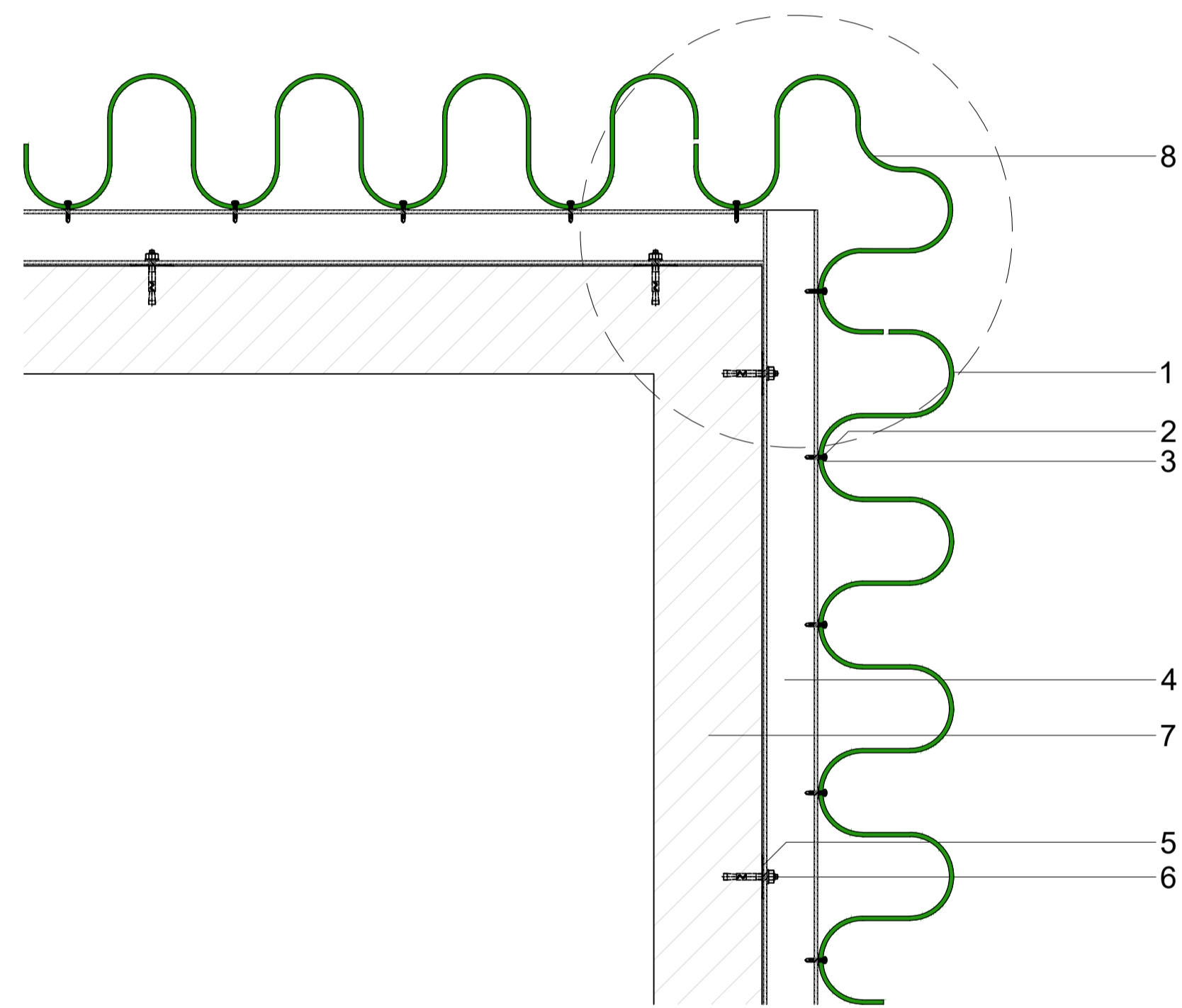

○ PMP U2-125 External Corner 90°
1:1

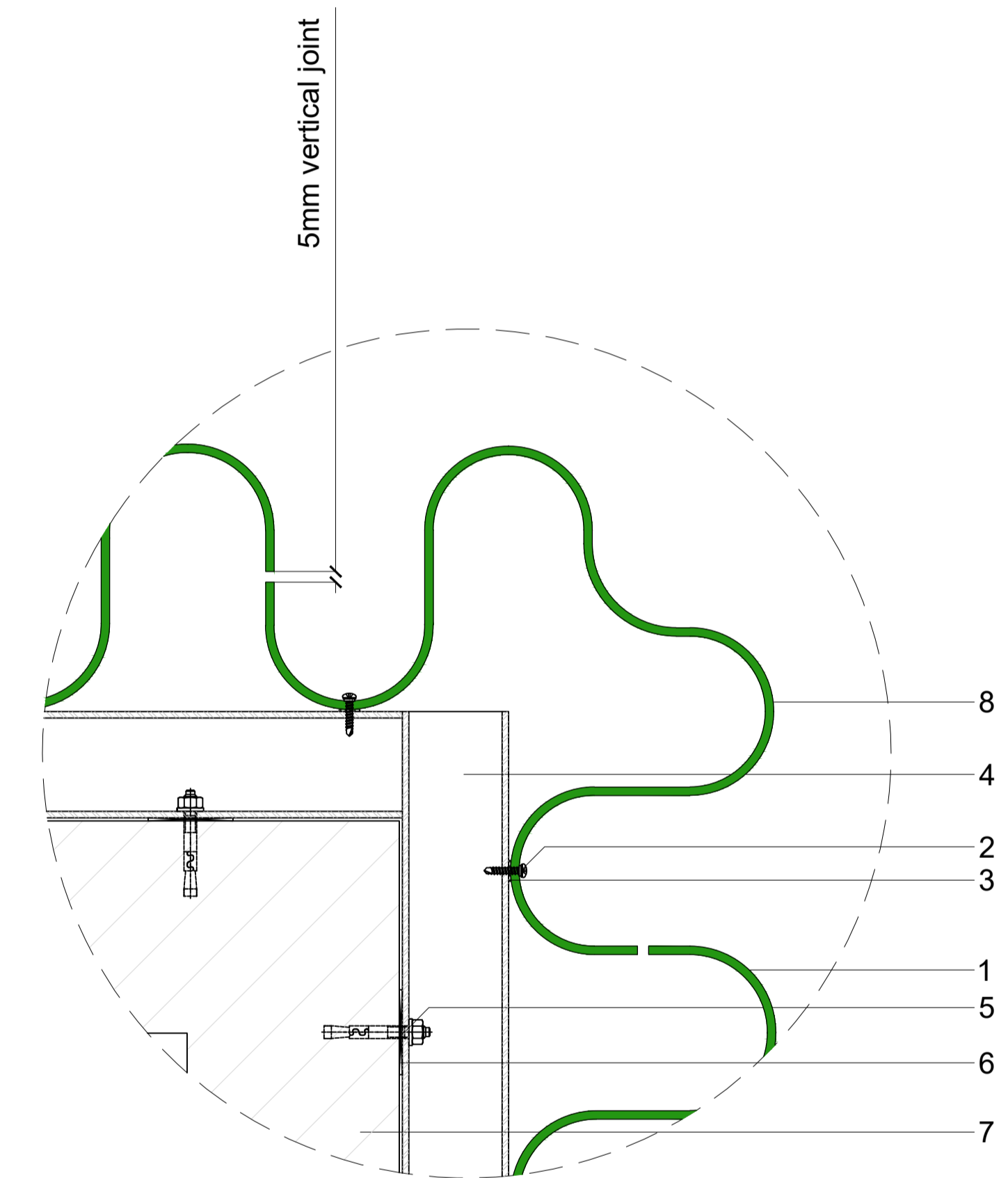

○ PMP U2-125 External Corner 90° Standard Detail
1:2

NOTE:
All design related drawings and concepts are property of SOLIDAL®.
Protected under Copyright Law.

PAGE:
2

DWG NAME:
SOLIDAL® PMP U2-125
External Corner 90° Details

SCALE:
1:1 & 1:2 @ A1
DATE:
21 / JUN / 2023

PMP
SOLIDAL®

SOLIDAL® PMP U2-125
 Perforated Metal Pressed
 Internal Corner 90° Detail

- 1 SOLIDAL® PMP T2®|T3®|T4®
- 2 S/S Metal Tek screw w/ EPDM Gasket
- 3 Isolation Barrier
- 4 Powder Coated RHS Support Frame
- 5 Anchor Bolt
- 6 Packing as required
- 7 Building Structure
- 8 SOLIDAL® PMP EC (External Corner) Module

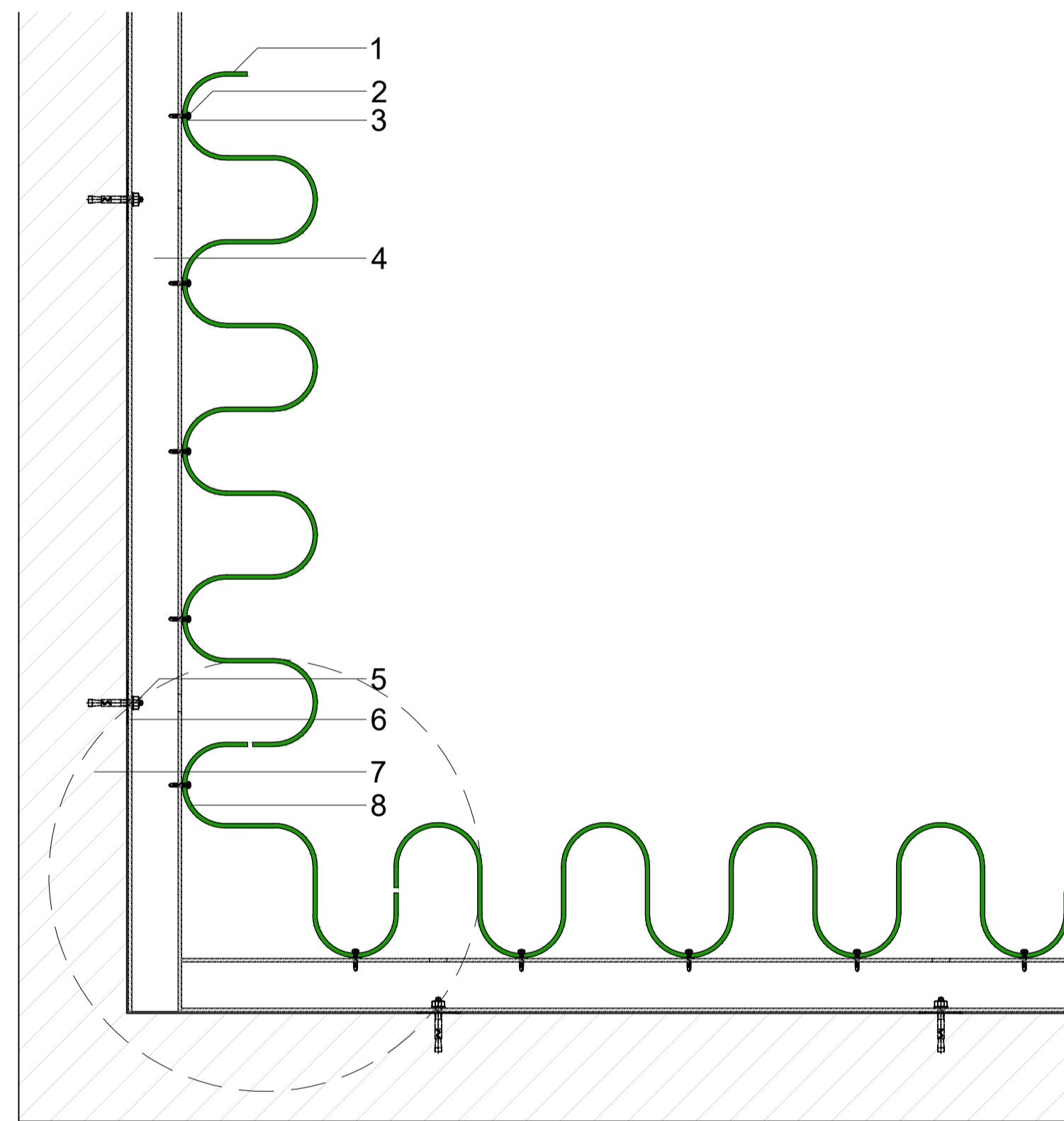

○ PMP U2-125 Internal Corner 90°
 1:1

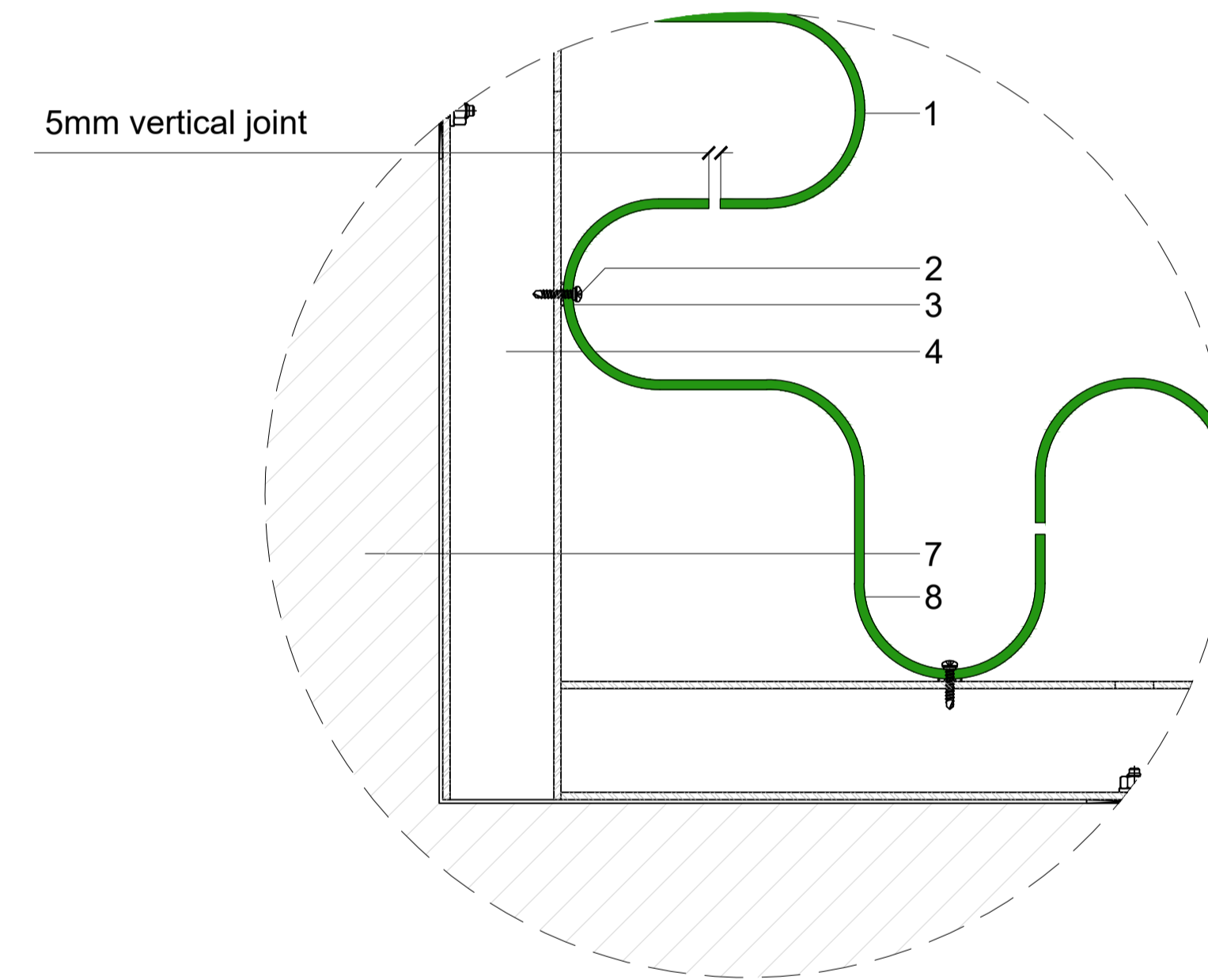

○ PMP U2-125 Internal Corner 90° Standard Detail
 1:2

NOTE: All design related drawings and concepts are property of SOLIDAL®. Protected under Copyright Law.	PAGE: <div style="font-size: 2em; font-weight: bold; text-align: center;">3</div>	DWG NAME: SOLIDAL® PMP U2-125 Internal Corner Details	SCALE: 1:1 & 1:2 @ A1	<div style="font-size: 1.5em; font-weight: bold;">PMP</div> <div style="font-size: 1.5em; font-weight: bold;">SOLIDAL®</div>
			DATE: 21 / JUN / 2023	

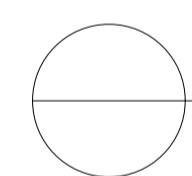
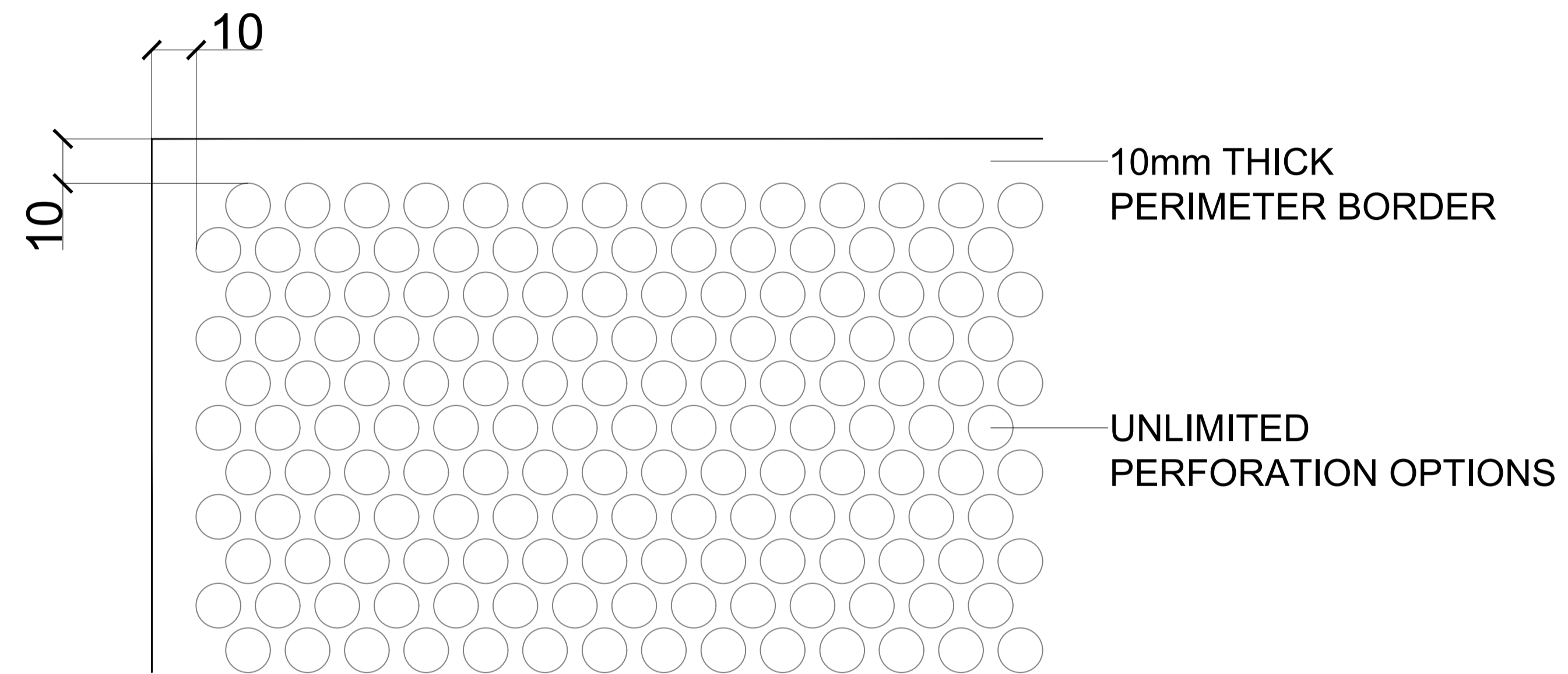

1:5

MODULE PERFORATION
BORDER DETAILS

NOTE:

All design related drawings and concepts are property of SOLIDAL®.
Protected under Copyright Law.

PAGE:

4

DWG NAME:

Module Perforation Details

SCALE:

1:5 @ A1

DATE:

21 / JUN / 2023

PMP

SOLIDAL®

SOLIDAL[®]

HEAD OFFICE

10/450 Elizabeth Street,
Surry Hills, Sydney,
NSW, Australia 2010

1300 252 325
info@solidal.com

solidal.com

DISCLAIMER:

All design related drawings and concepts are property of SOLIDAL[®].
Protected under Copyright Law.

SOLIDAL[®] PMP[®] is designed as a rainscreen cladding system.

Separation barrier to be used between dissimilar metals.

For SOLIDAL[®] Custom PMP[®] Modules, please discuss with SOLIDAL[®] representative.



SOLIDAL® PMP
Perforated Metal Pressed Screens
U2-175 Details

INDEX:

U2-175

U2-175 Vertical Joint Detail	1
U2-175 External Corner Detail	2
U2-175 Internal Corner Detail	3
Module Perforation Detail	4

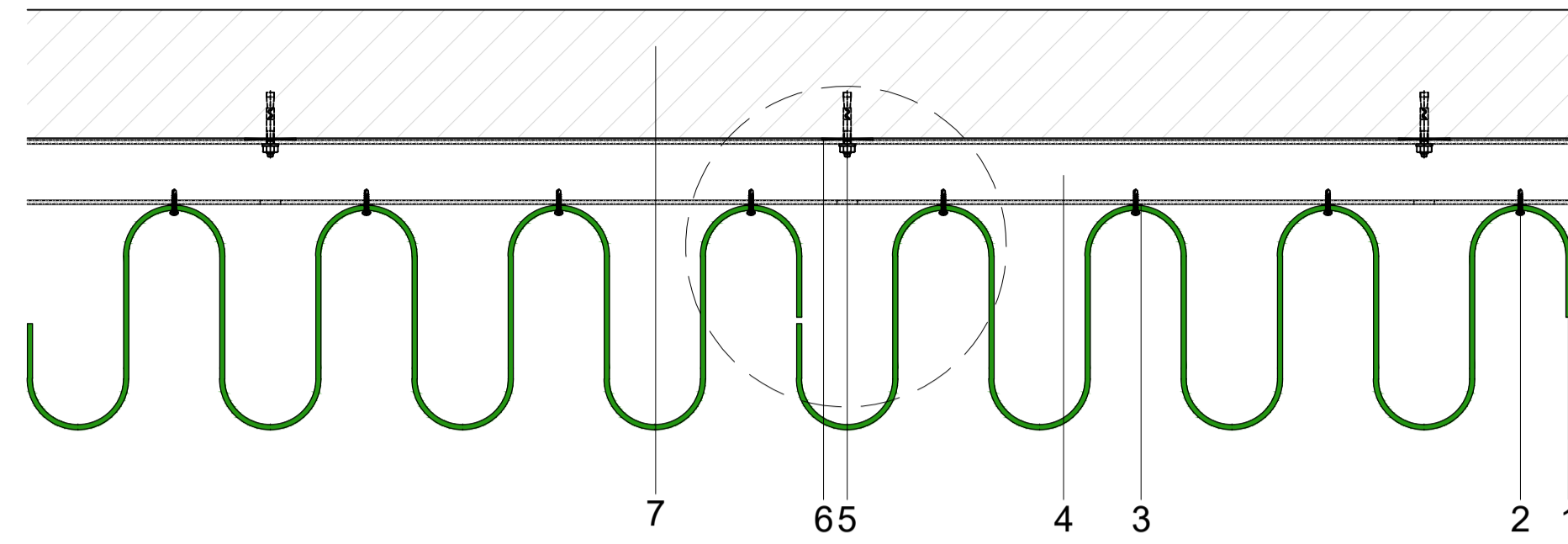

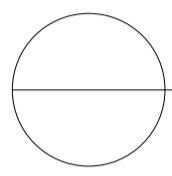
PMP U2-175 Vertical Joint
 1:1

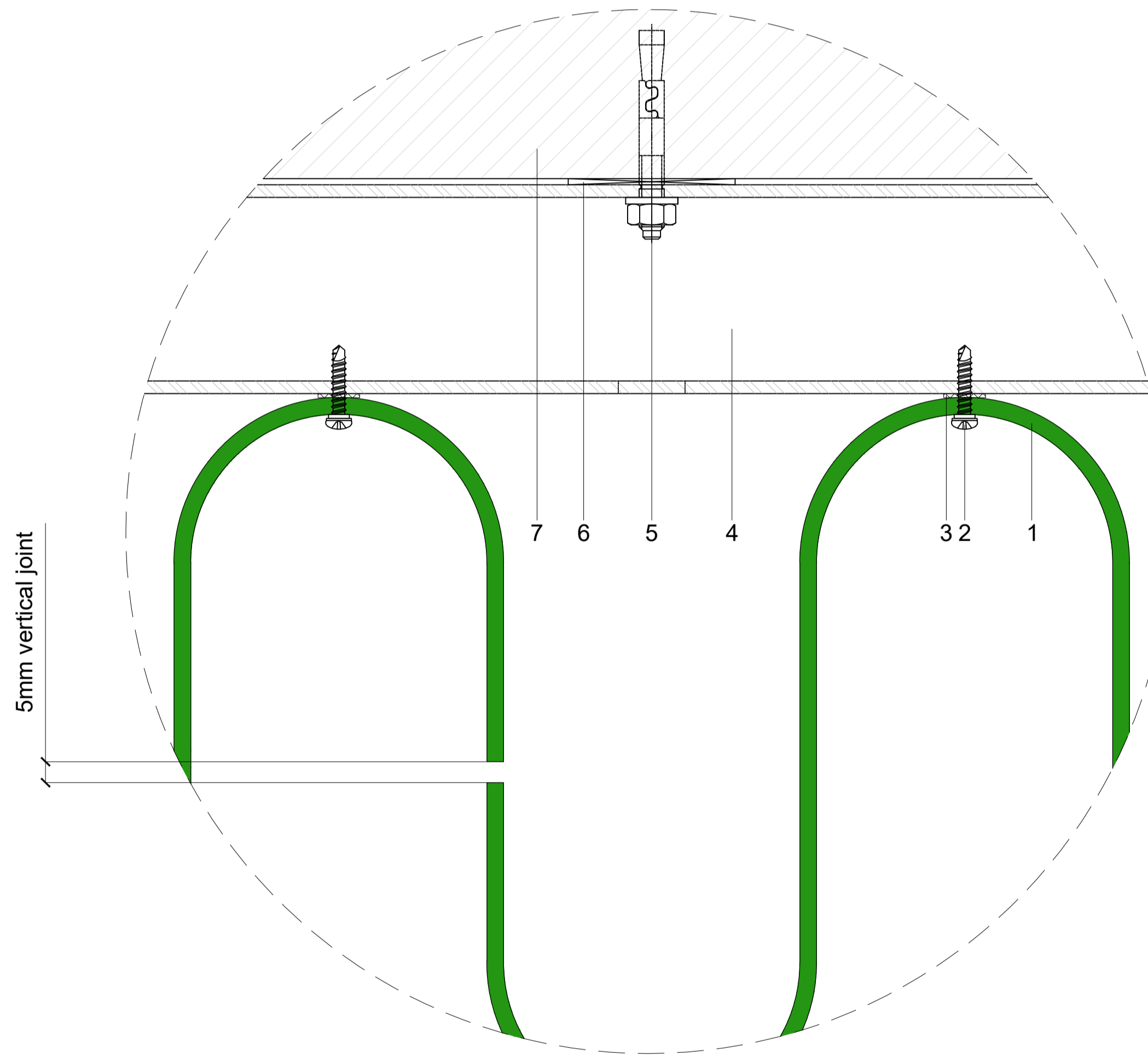

PMP U2-175 Vertical Joint Detail
 1:5

SOLIDAL® PMP U2-175
 Perforated Metal Pressed
 Vertical Joint - Typical Detail

- 1 SOLIDAL® PMP T2®|T3®|T4®
- 2 S/S Metal Tek screw w/ EPDM Gasket
- 3 Isolation Barrier
- 4 Powder Coated RHS Support Frame
- 5 Anchor Bolt
- 6 Packing as required
- 7 Building Structure

NOTE:

All design related drawings and concepts are property of SOLIDAL®.
Protected under Copyright Law.

PAGE:

1

DWG NAME:

SOLIDAL® PMP U2-175
Vertical Joint Detail

SCALE:

1:1 & 1:5 @ A1

DATE:

21 / JUN / 2023

PMP
SOLIDAL®

SOLIDAL® PMP U2-175
 Perforated Metal Pressed
 External Corner 90° Detail

- 1 SOLIDAL® PMP T2® | T3® | T4®
- 2 S/S Metal Tek screw w/ EPDM Gasket
- 3 Isolation Barrier
- 4 Powder Coated RHS Support Frame
- 5 Anchor Bolt
- 6 Packing as required
- 7 Building Structure
- 8 SOLIDAL® PMP EC (External Corner) Module

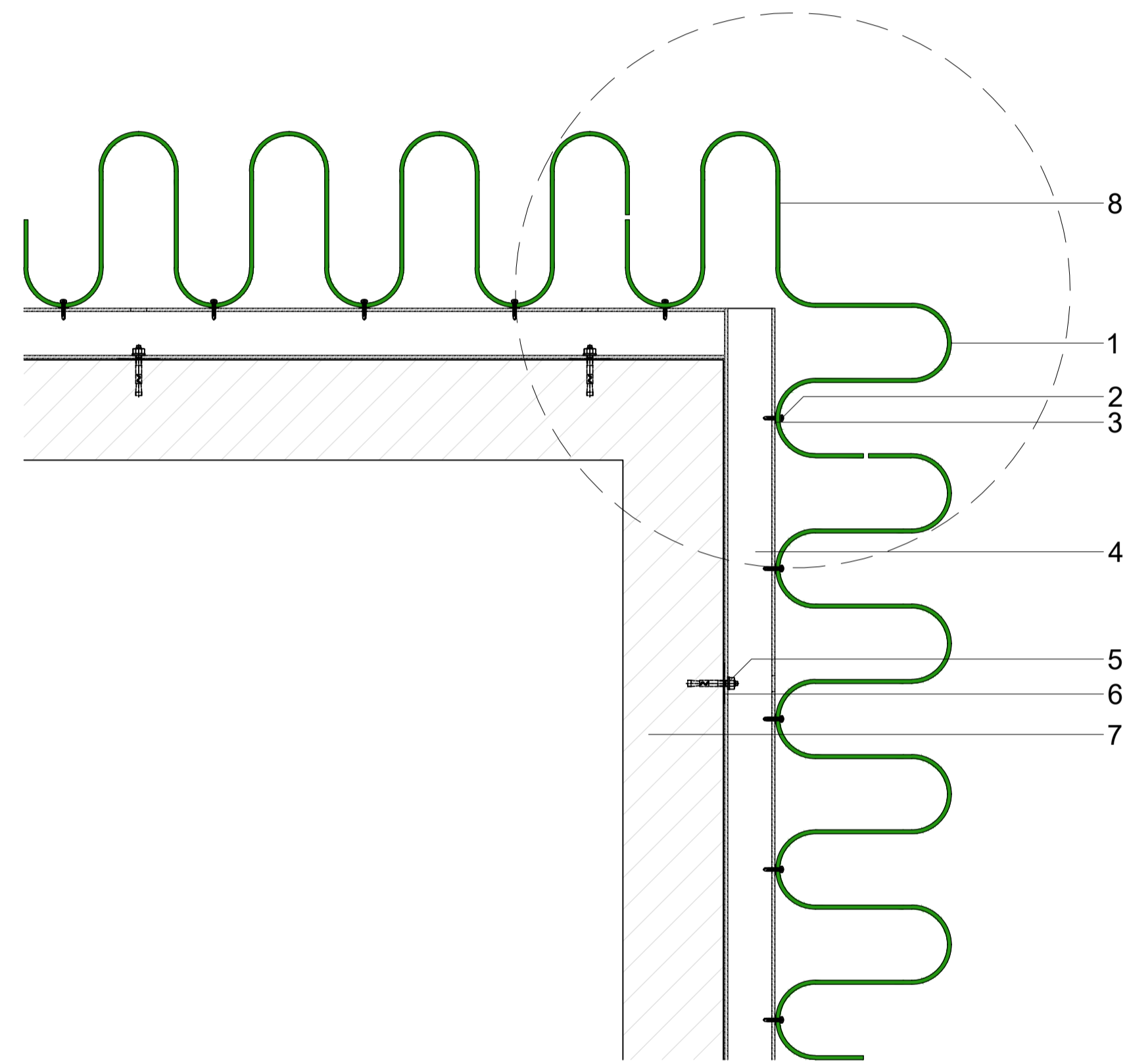

○ PMP U2-175 External Corner 90°
 1 : 1

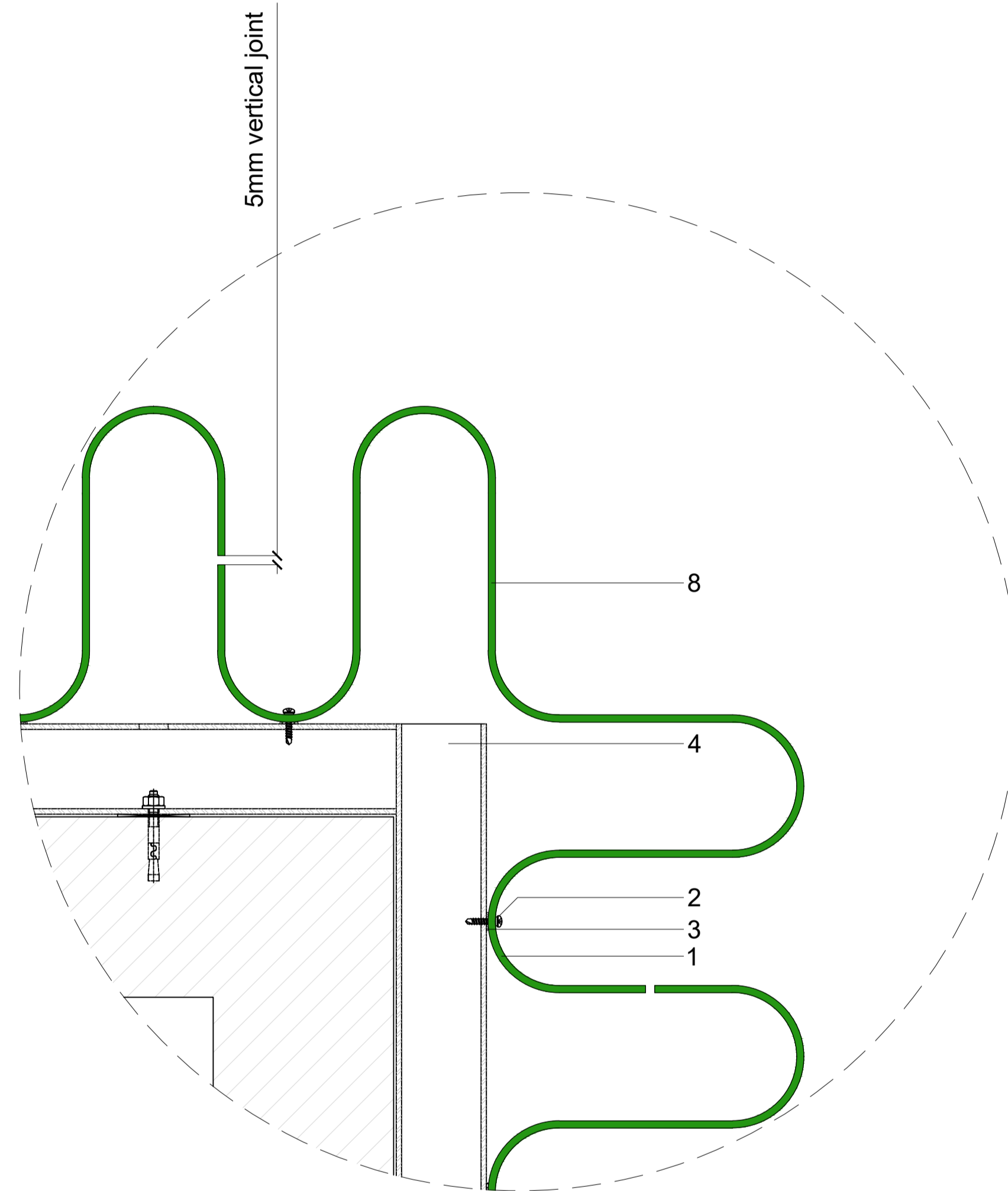

○ PMP U2-175 External Corner 90° Standard Detail
 1 : 2

NOTE:
 All design related drawings and concepts are property of SOLIDAL®.
 Protected under Copyright Law.

PAGE:
 2

DWG NAME:
 SOLIDAL® PMP U2-175
 External Corner 90° Details

SCALE:
 1:1 & 1:2 @ A1
DATE:
 21 / JUN / 2023

PMP
SOLIDAL®

SOLIDAL® PMP U2-175
 Perforated Metal Pressed
 Internal Corner 90° Detail

- 1 SOLIDAL® PMP T2®|T3®|T4®
- 2 S/S Metal Tek screw w/ EPDM Gasket
- 3 Isolation Barrier
- 4 Powder Coated RHS Support Frame
- 5 Anchor Bolt
- 6 Packing as required
- 7 Building Structure
- 8 SOLIDAL® PMP EC (External Corner) Module

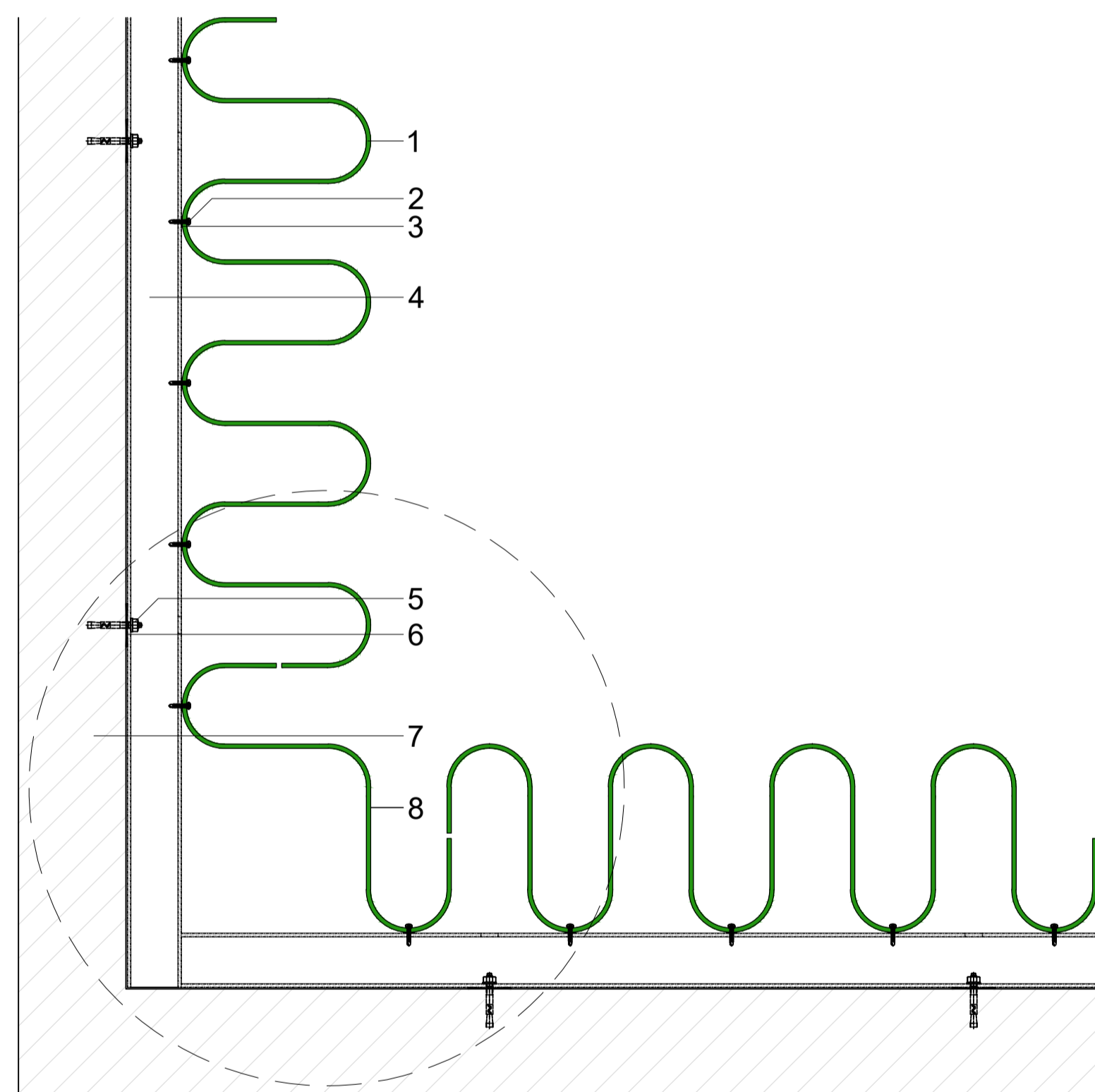

○ PMP U2-175 Internal Corner 90°
 1:1

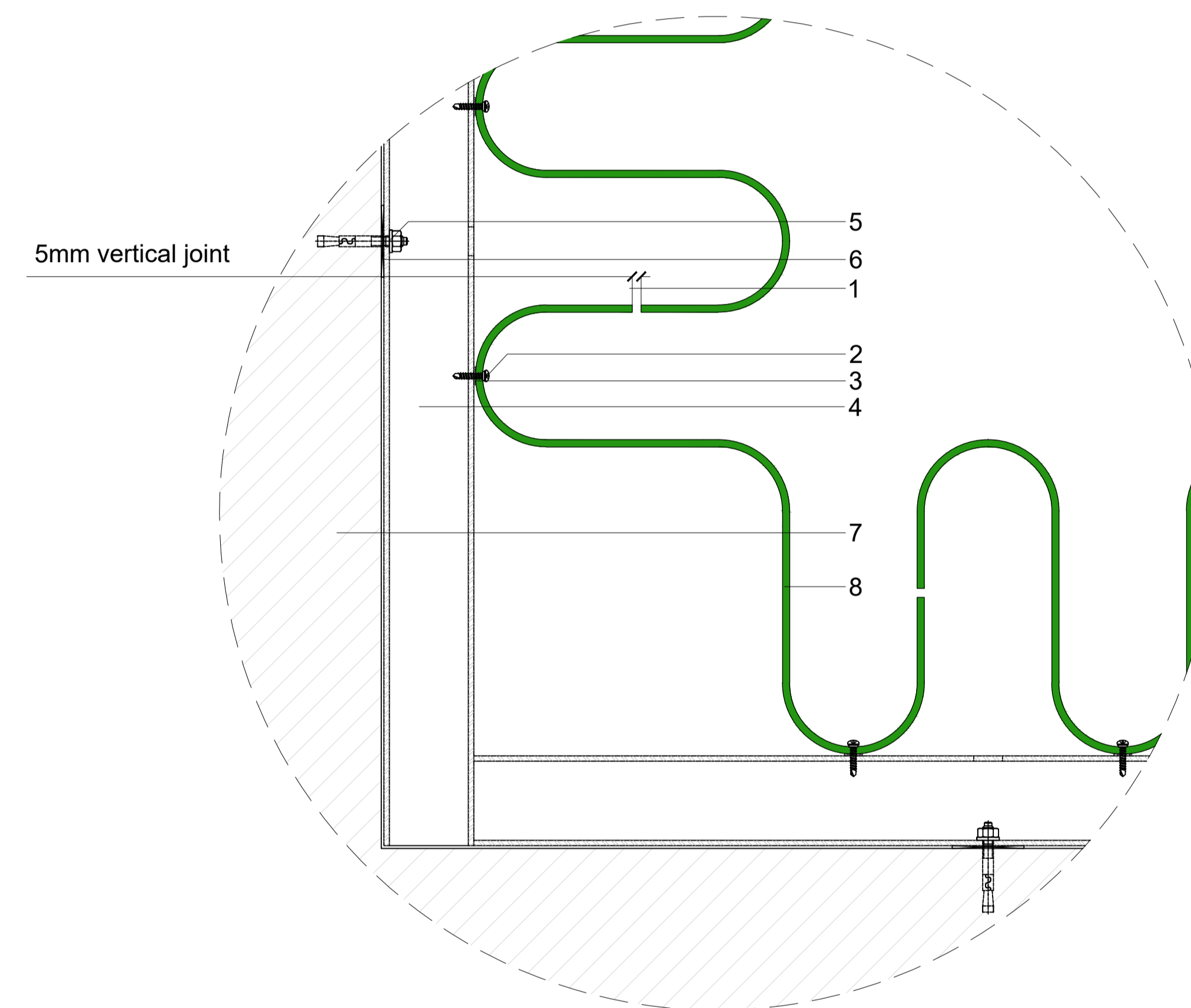

○ PMP U2-175 Internal Corner 90° Standard Detail
 1:2

NOTE:
 All design related drawings and concepts are property of SOLIDAL®.
 Protected under Copyright Law.

PAGE:
3

DWG NAME:
 SOLIDAL® PMP U2-175
 Internal Corner Details

SCALE:
 1:1 & 1:2 @ A1
DATE:
 21 / JUN / 2023

PMP
SOLIDAL®

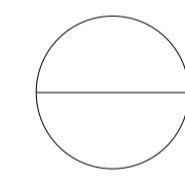
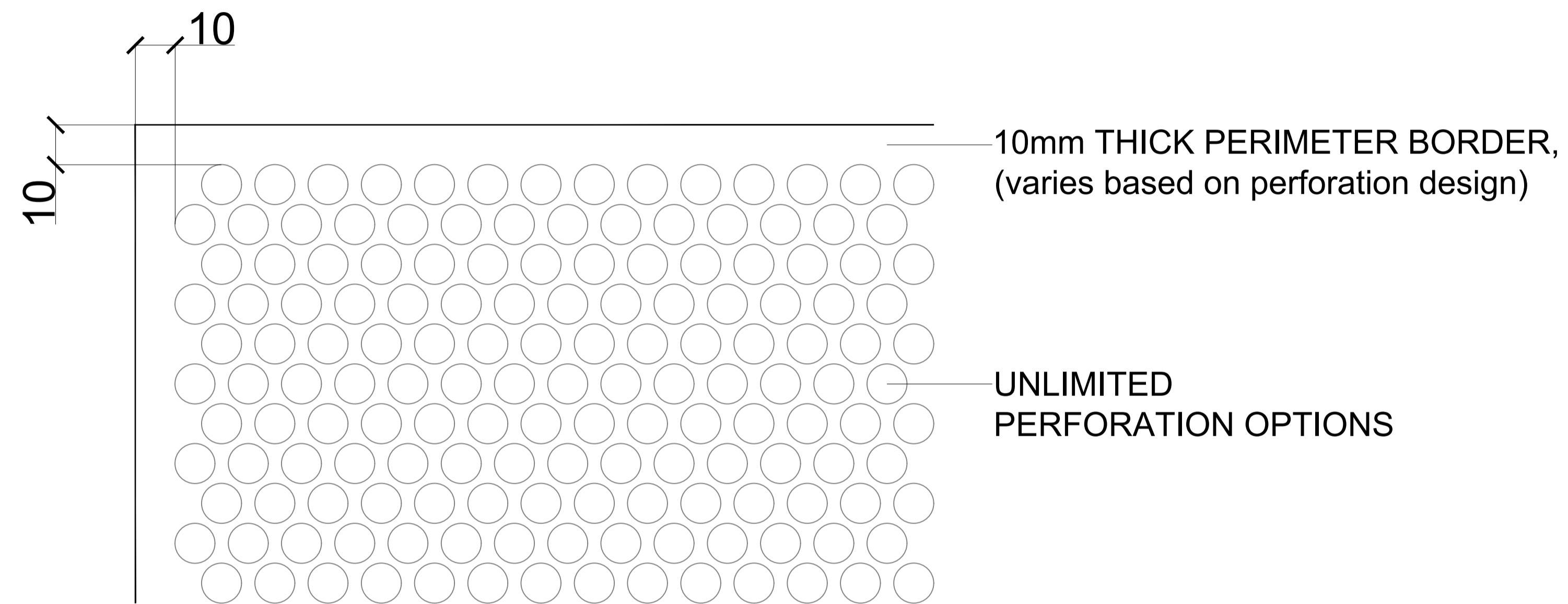

1:5

MODULE PERFORATION
BORDER DETAILS

NOTE:

All design related drawings and concepts are property of SOLIDAL®.
Protected under Copyright Law.

PAGE:

4

DWG NAME:

Module Perforation Details

SCALE:

1:5 @ A1

DATE:

21 / JUN / 2023

PMP

SOLIDAL®

SOLIDAL[®]

HEAD OFFICE

10/450 Elizabeth Street,
Surry Hills, Sydney,
NSW, Australia 2010

1300 252 325
info@solidal.com

solidal.com

DISCLAIMER:

All design related drawings and concepts are property of SOLIDAL[®].
Protected under Copyright Law.

SOLIDAL[®] PMP[®] is designed as a rainscreen cladding system.

Separation barrier to be used between dissimilar metals.

For SOLIDAL[®] Custom PMP[®] Modules, please discuss with SOLIDAL[®] representative.