

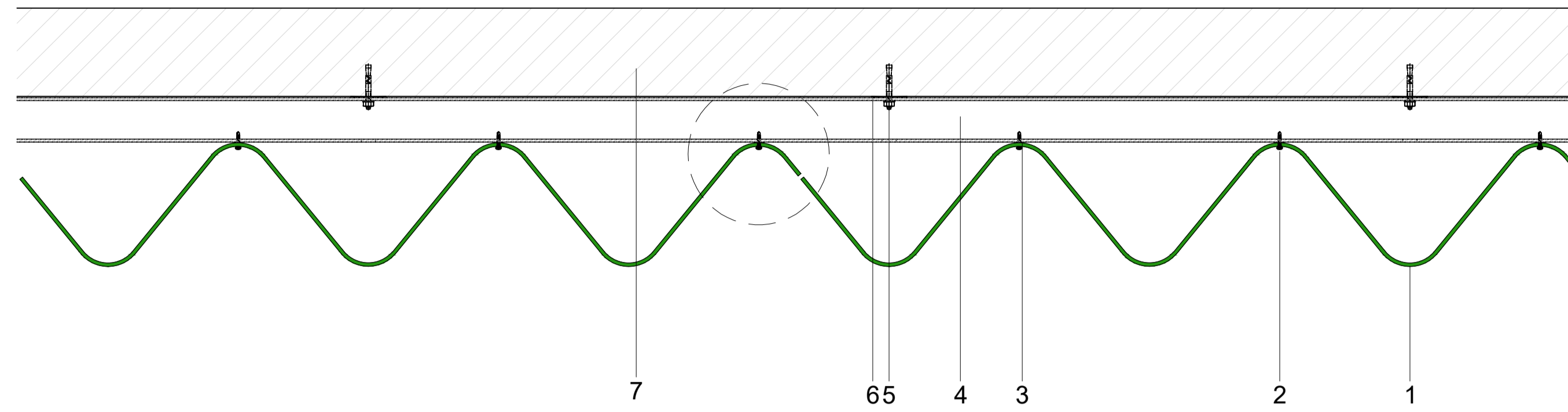

SOLIDAL® PMP
Perforated Metal Pressed Screens
V2 Details

INDEX:

V2	
V2 Vertical Joint Detail	1
V2 External Corner Detail	2
V2 Internal Corner Detail	3
Module Perforation Detail	4



○ PMP V2 Vertical Joint
1:1

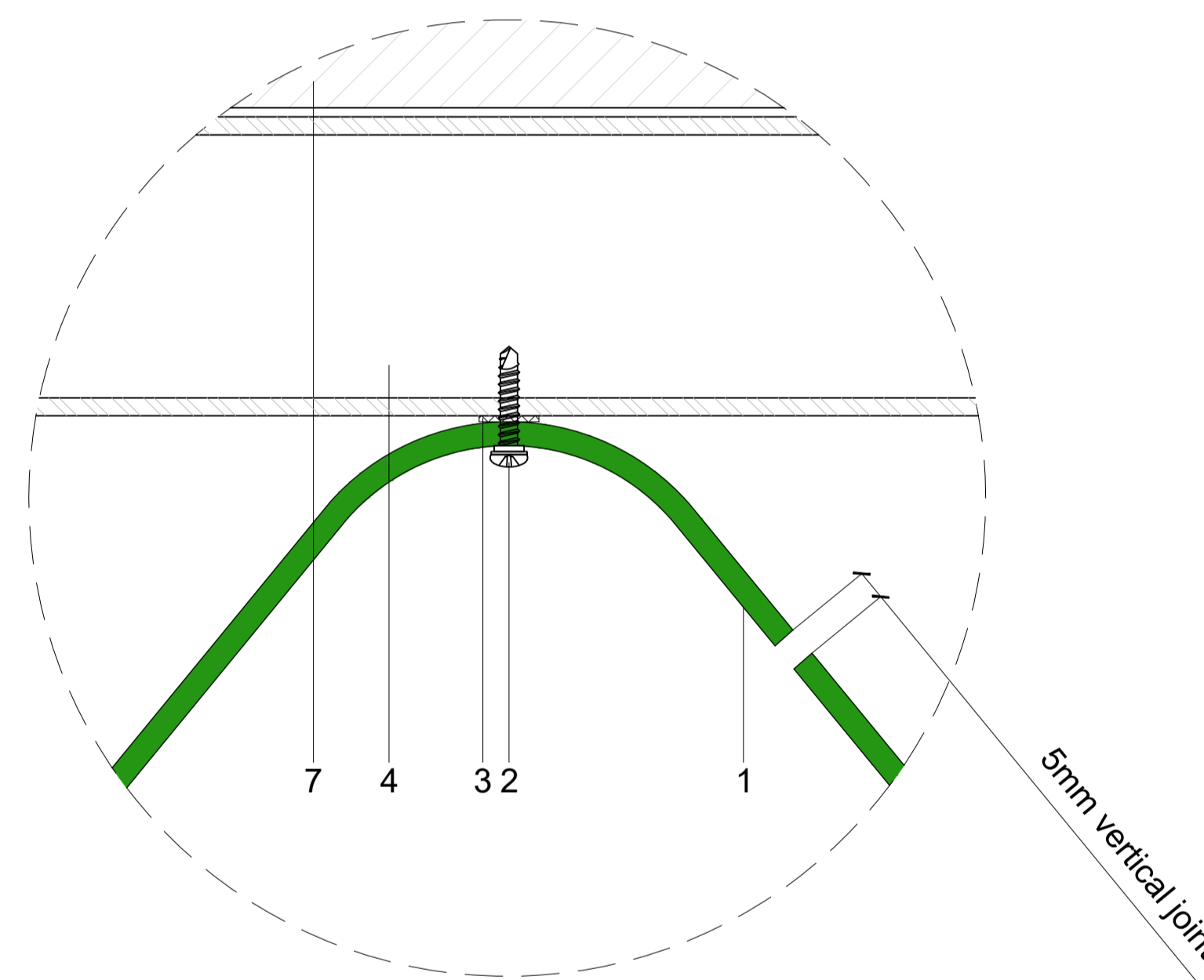

SOLIDAL® PMP V2
Perforated Metal Pressed
Vertical Joint - Typical Detail

- 1 SOLIDAL® PMP T2® | T3® | T4®
- 2 S/S Metal Tek screw w/ EPDM Gasket
- 3 Isolation Barrier
- 4 Powder Coated RHS Support Frame
- 5 Anchor Bolt
- 6 Packing as required
- 7 Building Structure

○ PMP V2 Vertical Joint Detail
1:5

NOTE:
All design related drawings and concepts are property of SOLIDAL®.
Protected under Copyright Law.

PAGE:
1

DWG NAME:
SOLIDAL® PMP V2
Vertical Joint Detail

SCALE:
1:1 & 1:5 @ A1
DATE:
21 / JUN / 2023

PMP
SOLIDAL®

SOLIDAL® PMP V2
Perforated Metal Pressed
External Corner 90° Detail

- 1 SOLIDAL® PMP T2®|T3®|T4®
- 2 S/S Metal Tek screw w/ EPDM Gasket
- 3 Isolation Barrier
- 4 Powder Coated RHS Support Frame
- 5 Anchor Bolt
- 6 Packing as required
- 7 Building Structure
- 8 SOLIDAL® PMP EC (External Corner) Module

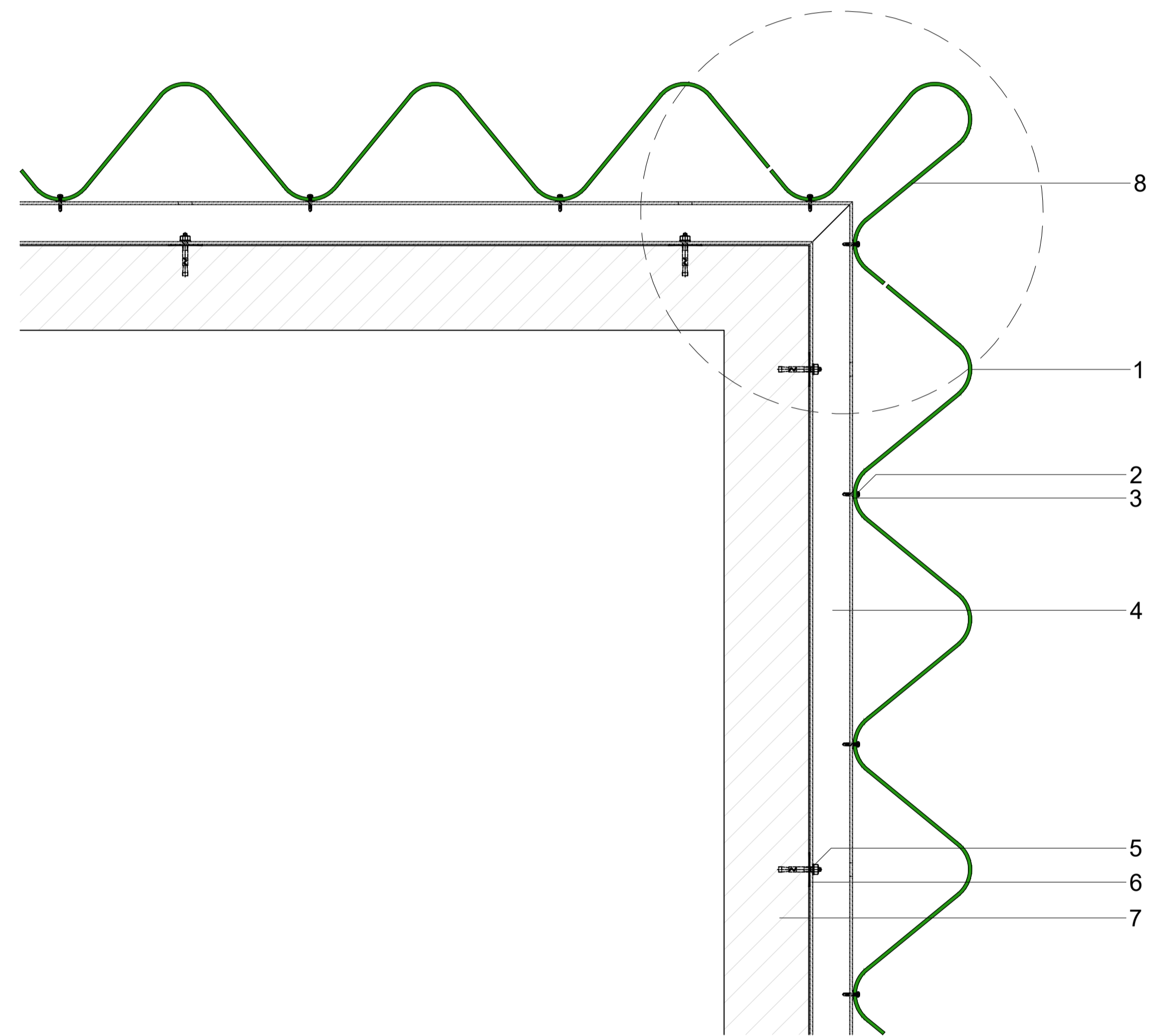

○ PMP V2 External Corner 90°
1 : 1

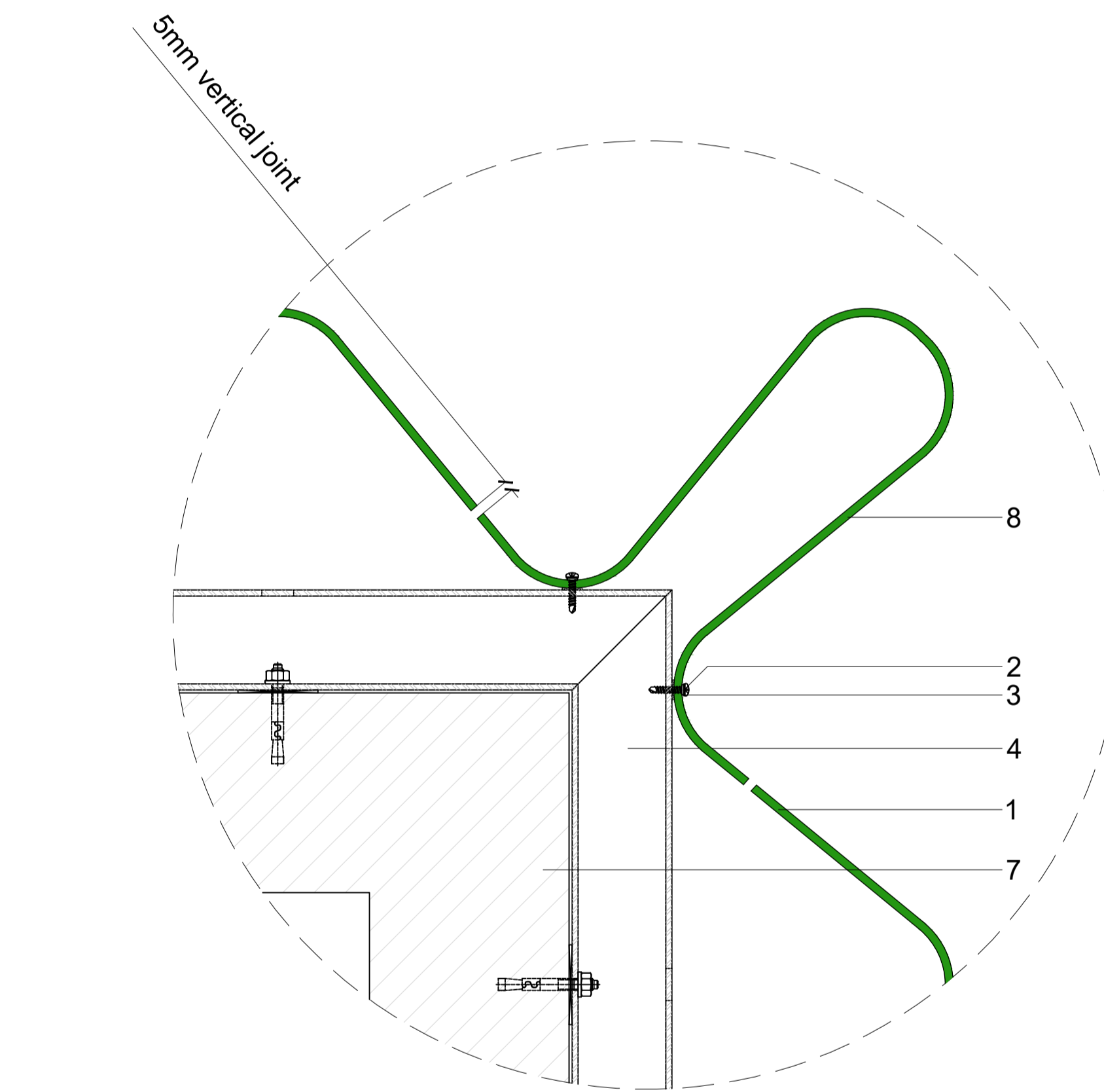

○ PMP V2 External Corner 90° Optional Detail
1 : 2

NOTE:
All design related drawings and concepts are property of SOLIDAL®.
Protected under Copyright Law.

PAGE:
2

DWG NAME:
SOLIDAL® PMP V2
External Corner 90° Details

SCALE:
1:1 & 1:2 @ A1
DATE:
21 / JUN / 2023

PMP
SOLIDAL®

SOLIDAL® PMP V2
Perforated Metal Pressed
Internal Corner 90° Detail

- 1 SOLIDAL® PMP T2® | T3® | T4®
 - 2 S/S Metal Tek screw w/ EPDM Gasket
 - 3 Isolation Barrier
 - 4 Powder Coated RHS Support Frame
 - 5 Anchor Bolt
 - 6 Packing as required
 - 7 Building Structure
 - 8 SOLIDAL® PMP IC (Internal Corner) Module
- Refer to SOLIDAL® Accessories Brochure

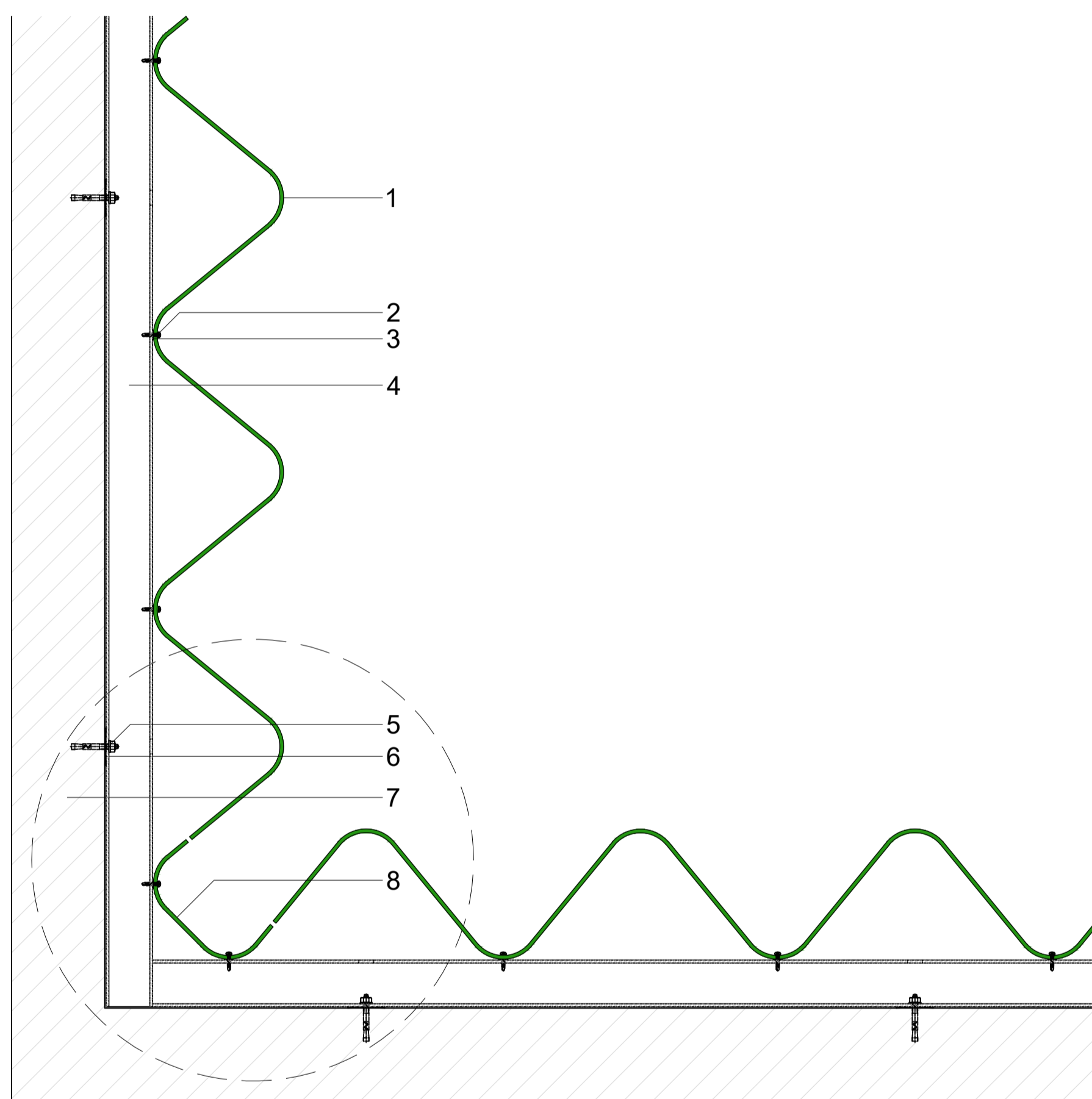

○ PMP V2 Internal Corner 90°
1:1

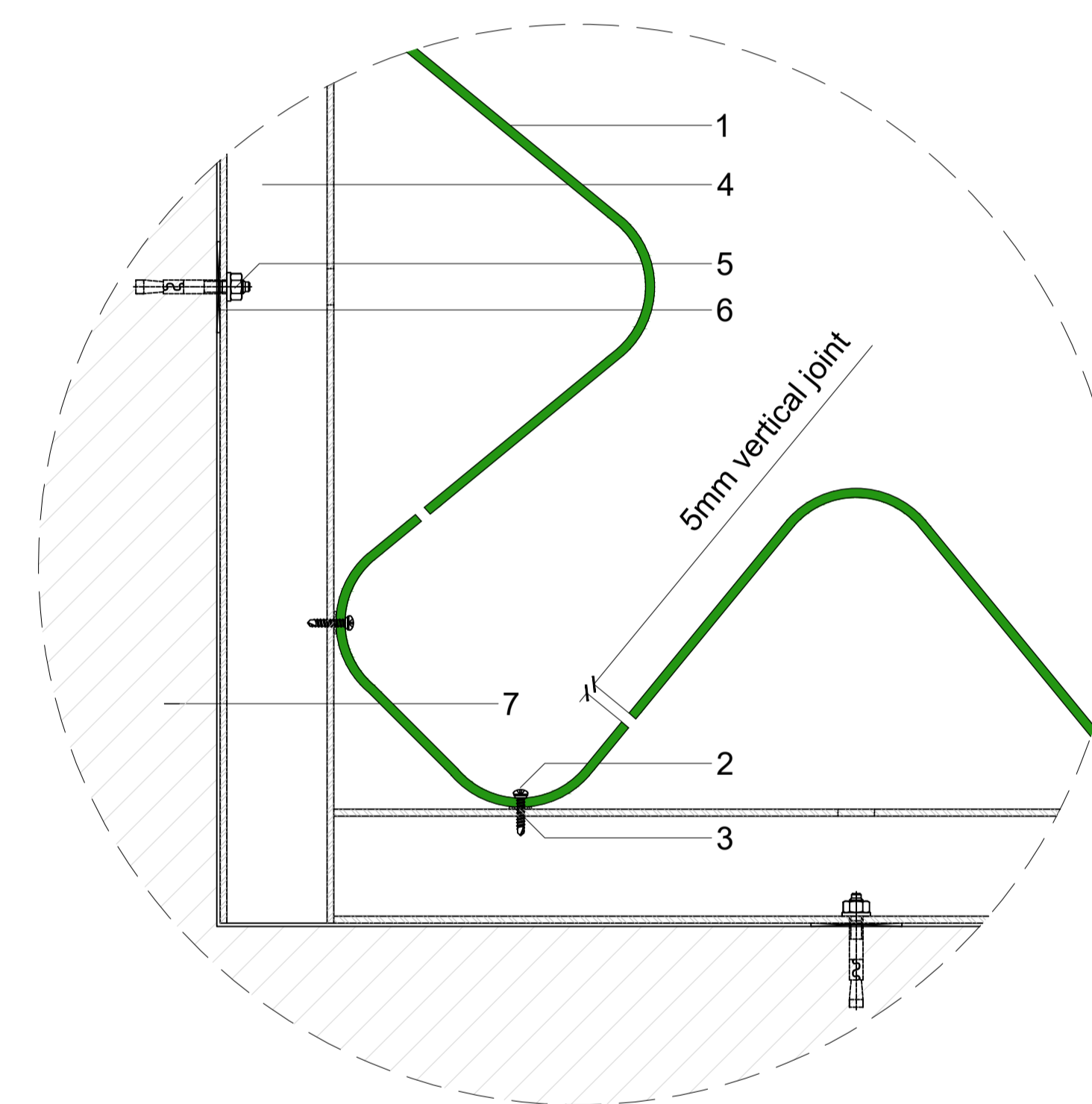

○ PMP V2 Internal Corner 90° Optional Detail
1:2

NOTE:
All design related drawings and concepts are property of SOLIDAL®.
Protected under Copyright Law.

PAGE:
3

DWG NAME:
SOLIDAL® PMP V2
Internal Corner Details

SCALE:
1:1 & 1:2 @ A1
DATE:
21 / JUN / 2023

PMP
SOLIDAL®

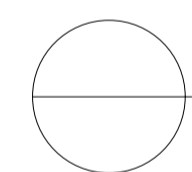
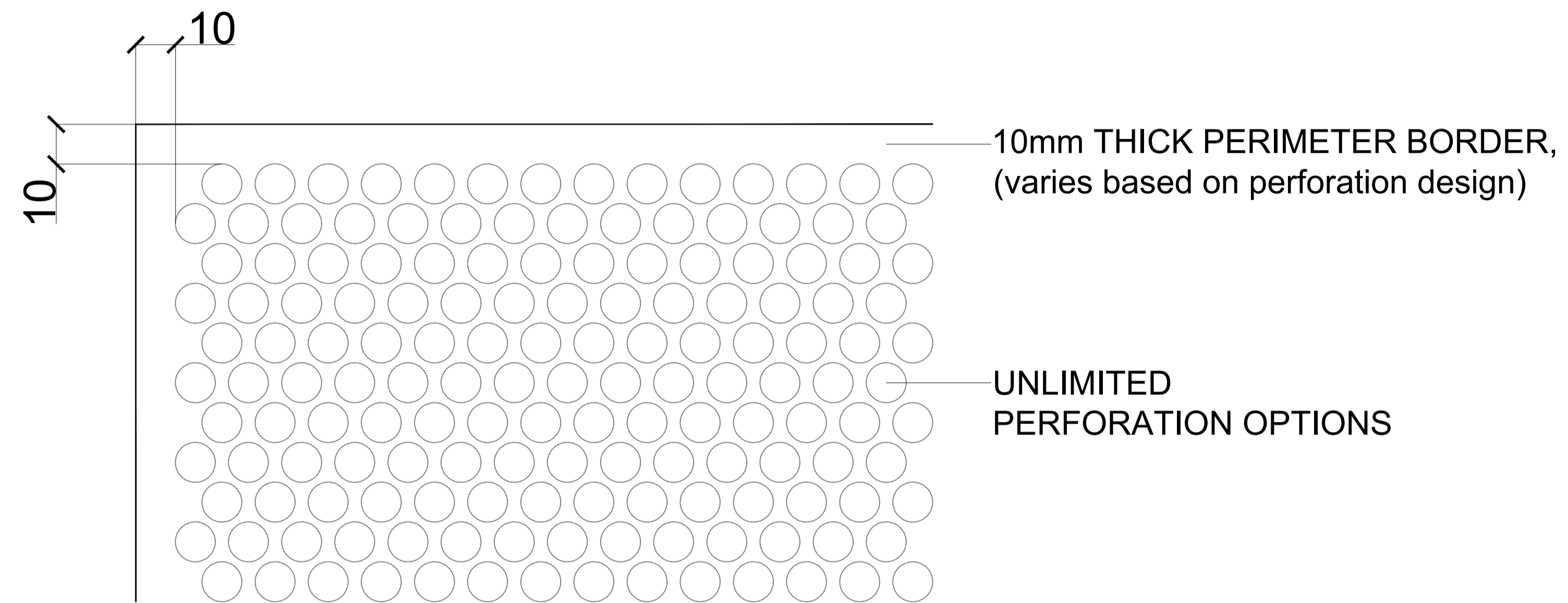

1:5

**MODULE PERFORATION
BORDER DETAILS**

NOTE: All design related drawings and concepts are property of SOLIDAL®. Protected under Copyright Law.	PAGE: <div style="font-size: 2em; font-weight: bold; text-align: center;">4</div>	DWG NAME: Module Perforation Details	SCALE: 1:5 @ A1	PMP SOLIDAL®
			DATE: 21 / JUN / 2023	

SOLIDAL[®]

HEAD OFFICE

10/450 Elizabeth Street,
Surry Hills, Sydney,
NSW, Australia 2010

1300 252 325
info@solidal.com

solidal.com

DISCLAIMER:

All design related drawings and concepts are property of SOLIDAL[®].
Protected under Copyright Law.

SOLIDAL[®] PMP[®] is designed as a rainscreen cladding system.

Separation barrier to be used between dissimilar metals.

For SOLIDAL[®] Custom PMP[®] Modules, please discuss with SOLIDAL[®] representative.