

SOLIDAL[®]
TEGO[®] Oblique

SOLIDAL[®] **TEGO**[®]
Light and Shade Modular Series
TEGO[®] Concave Details

INDEX:

Abutment Detail	1
Parapet Capping	2
Base Wall	3
Base Wall	4
Horizontal Joint	5
Vertical Joint	6
External Corner	7
Soffit Detail	8
Soffit Detail	9
Internal Corner	10
Window Details	11
Window Details	12
Window Details	13
Window Details	14

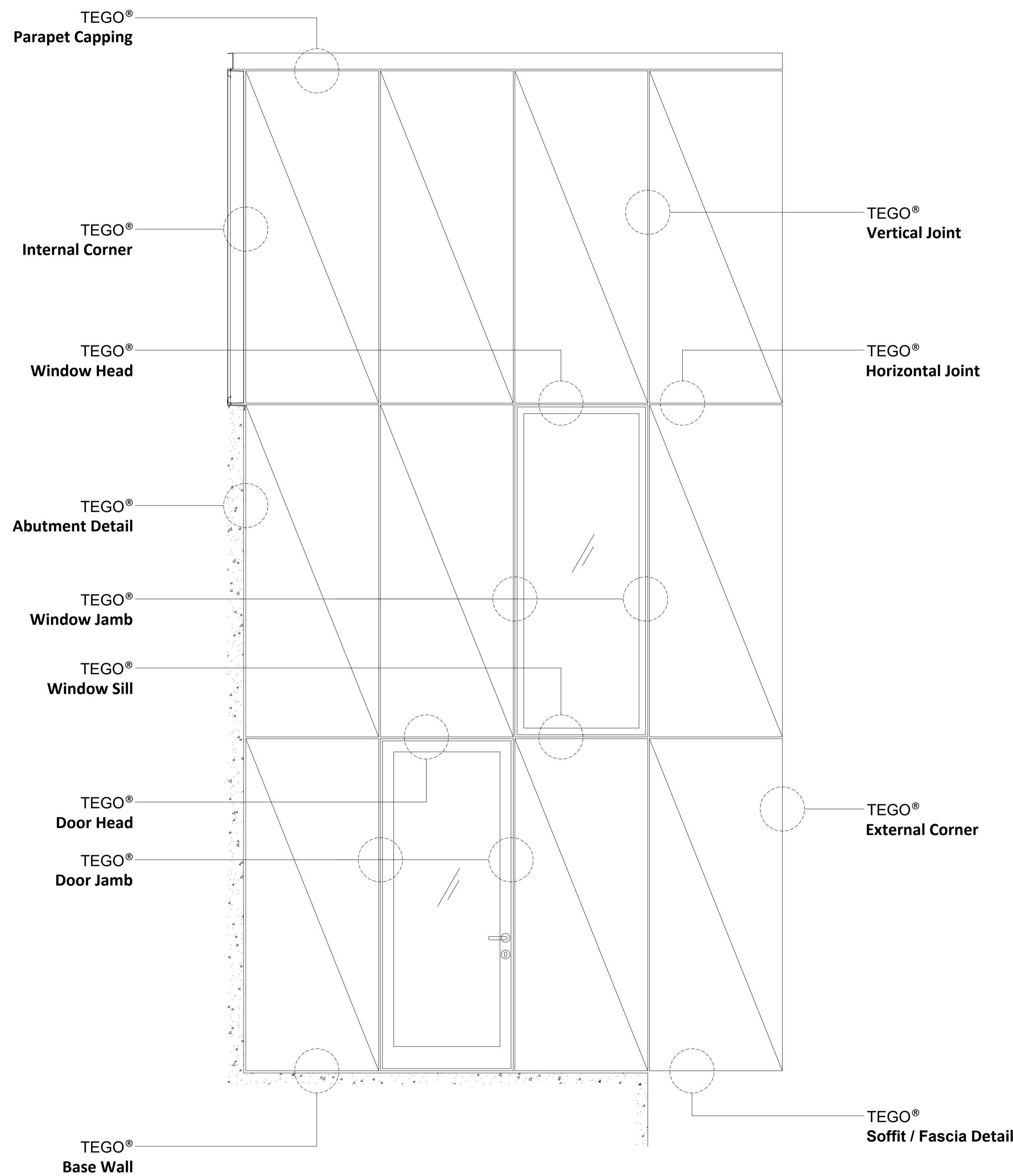

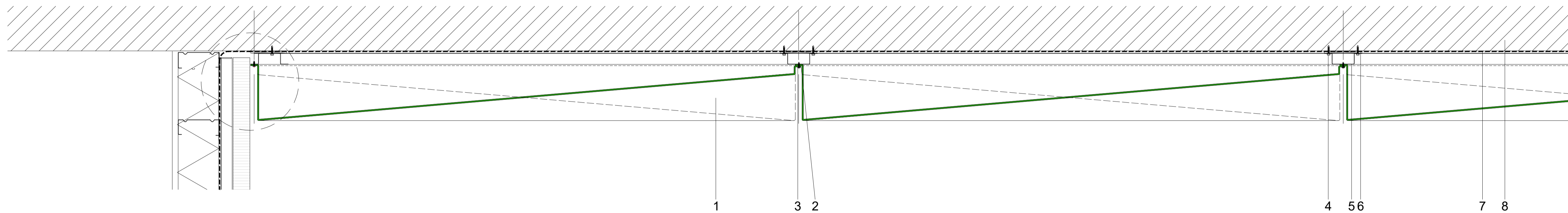

 TEGO® Oblique
 Typical Details Diagram

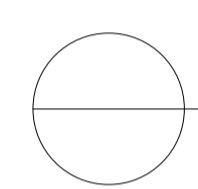

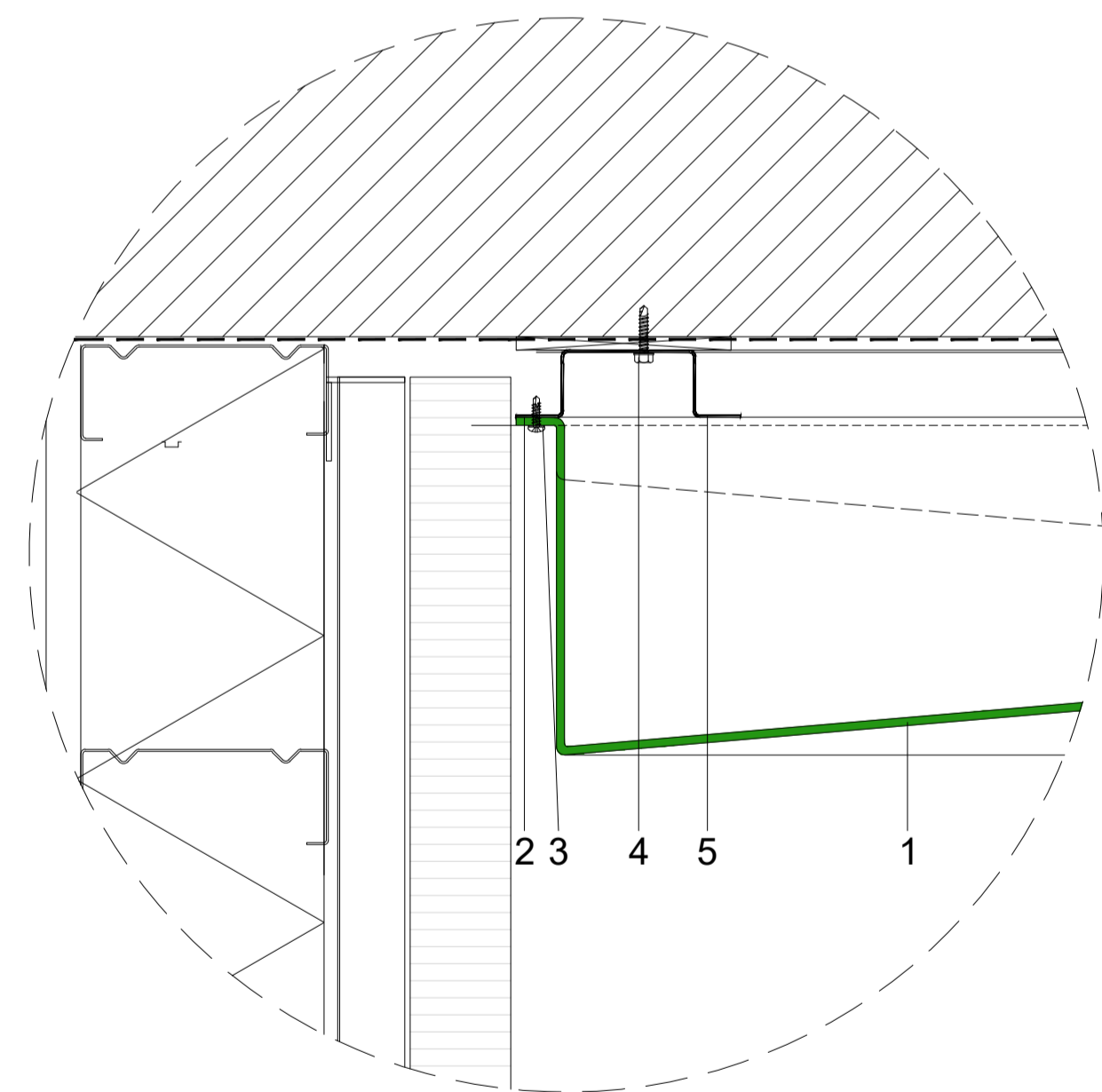
TEGO® Abutment Detail
 1 : 5

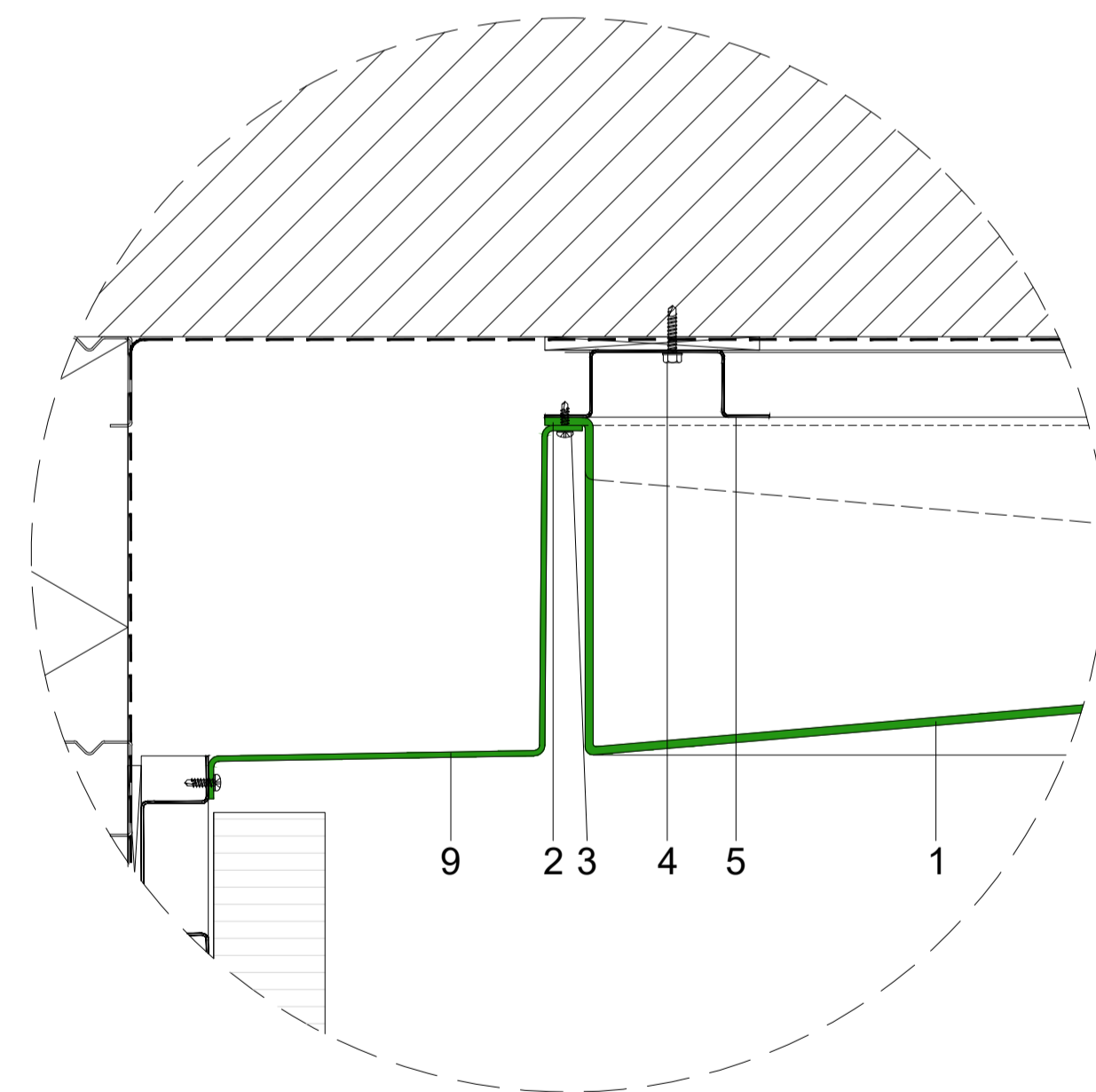

TEGO® Abutment Detail
 1 : 2



TEGO® Abutment Detail - Optional
 1 : 2

SOLIDAL® TEGO®
 Typical Abutment Detail

- 1 SOLIDAL® TEGO® (T3® Solid Aluminium)
- 2 SOLIDAL® Double fold
- 3 Tek screw type 1
- 4 Tek screw type 2
- 5 Top hat
- 6 Packing as required
- 7 Weather seal layer
- 8 Building structure
- 9 SOLIDAL® TEGO® ICA (Internal Corner & Abutment) Module.
Refer to SOLIDAL® Accessories Brochure.

NOTE:

All design related drawings and concepts are property of SOLIDAL®.
Protected under Copyright Law.

PAGE:

1

DWG NAME:

SOLIDAL® TEGO® Oblique
Abutment Detail

SCALE:

1 : 1 @ A1

DATE:

20 / MAR / 2023

TEGO®

SOLIDAL®

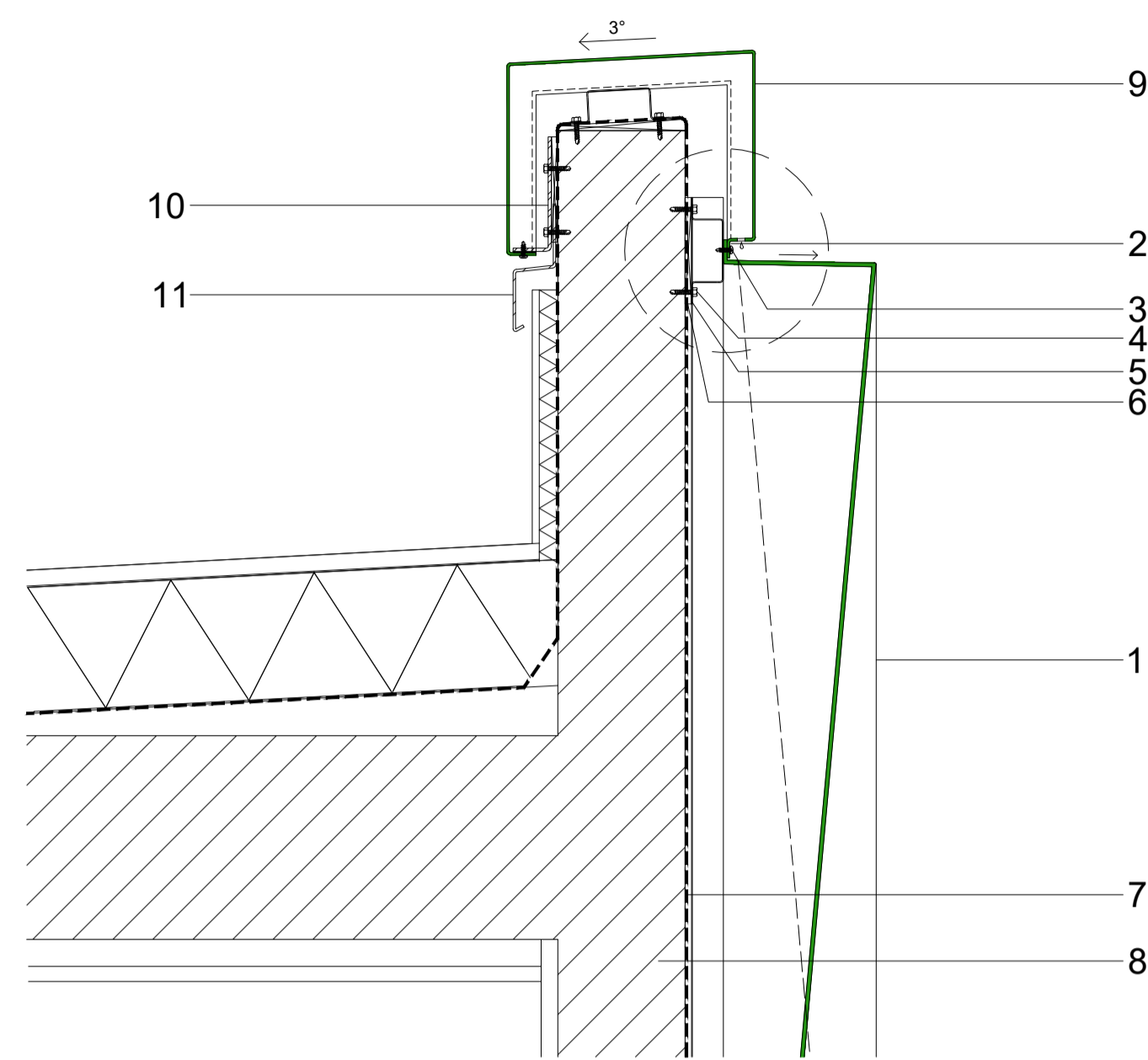

TEGO® Parapet Capping
1 : 5

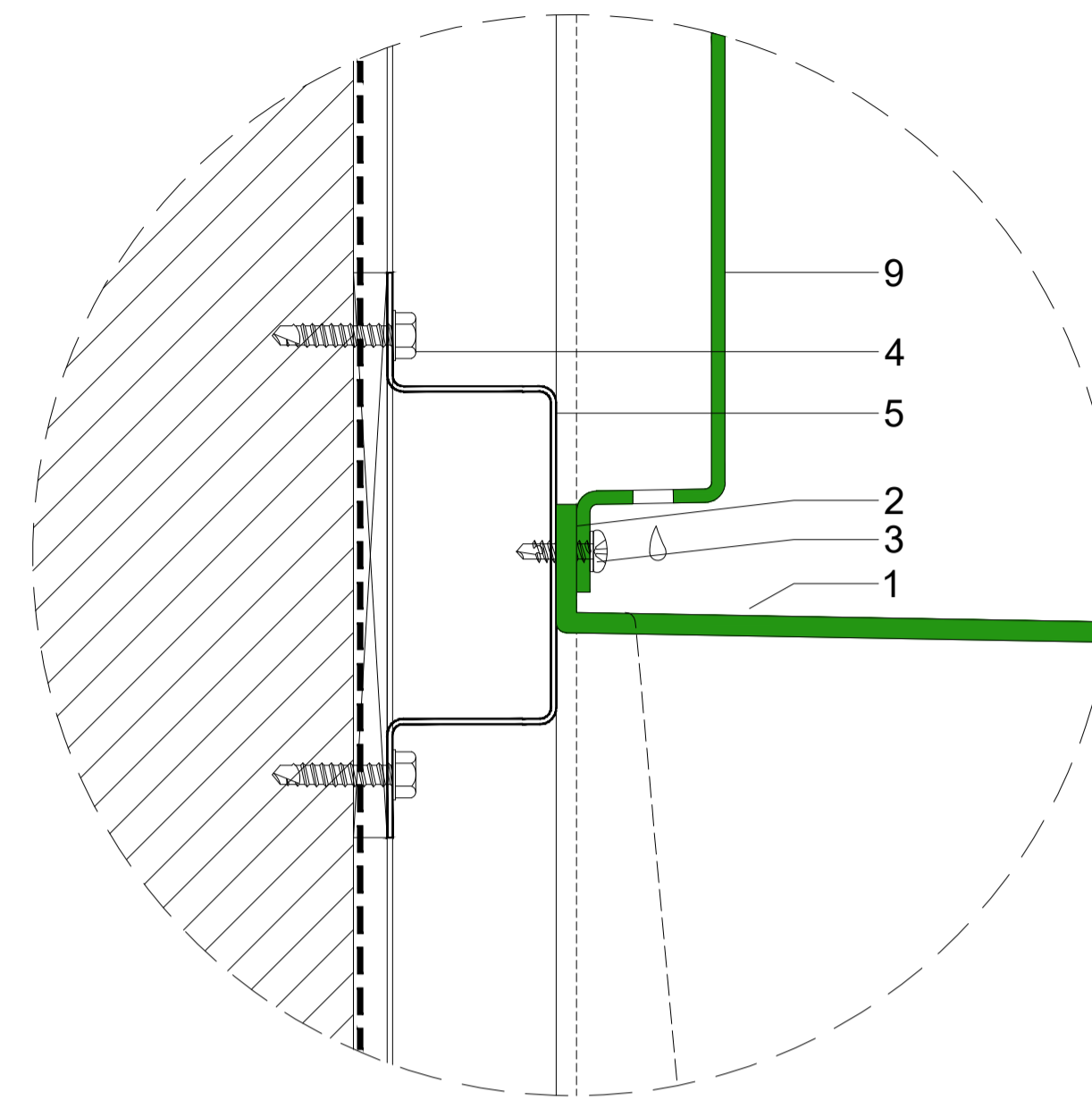

TEGO® Parapet Capping Detail
1 : 1

SOLIDAL® TEGO®
Parapet Capping - Typical Detail

- 1 SOLIDAL® TEGO® Module (T3® Solid Aluminium)
- 2 SOLIDAL® Double-fold
- 3 Tek screw type 1
- 4 Tek screw type 2
- 5 Top hat
- 6 Packing as required
- 7 Weather seal layer
- 8 Building structure
- 9 SOLIDAL® PC (Parapet Capping) Module. T2® Solid Aluminium.
Refer to SOLIDAL® Accessories Brochure.
- 10 Aluminium Angle fixed in place
- 11 SOLIDAL® SA (Starter & Abutment) Module. T2® Solid Aluminium.
Refer to SOLIDAL® Accessories Brochure.

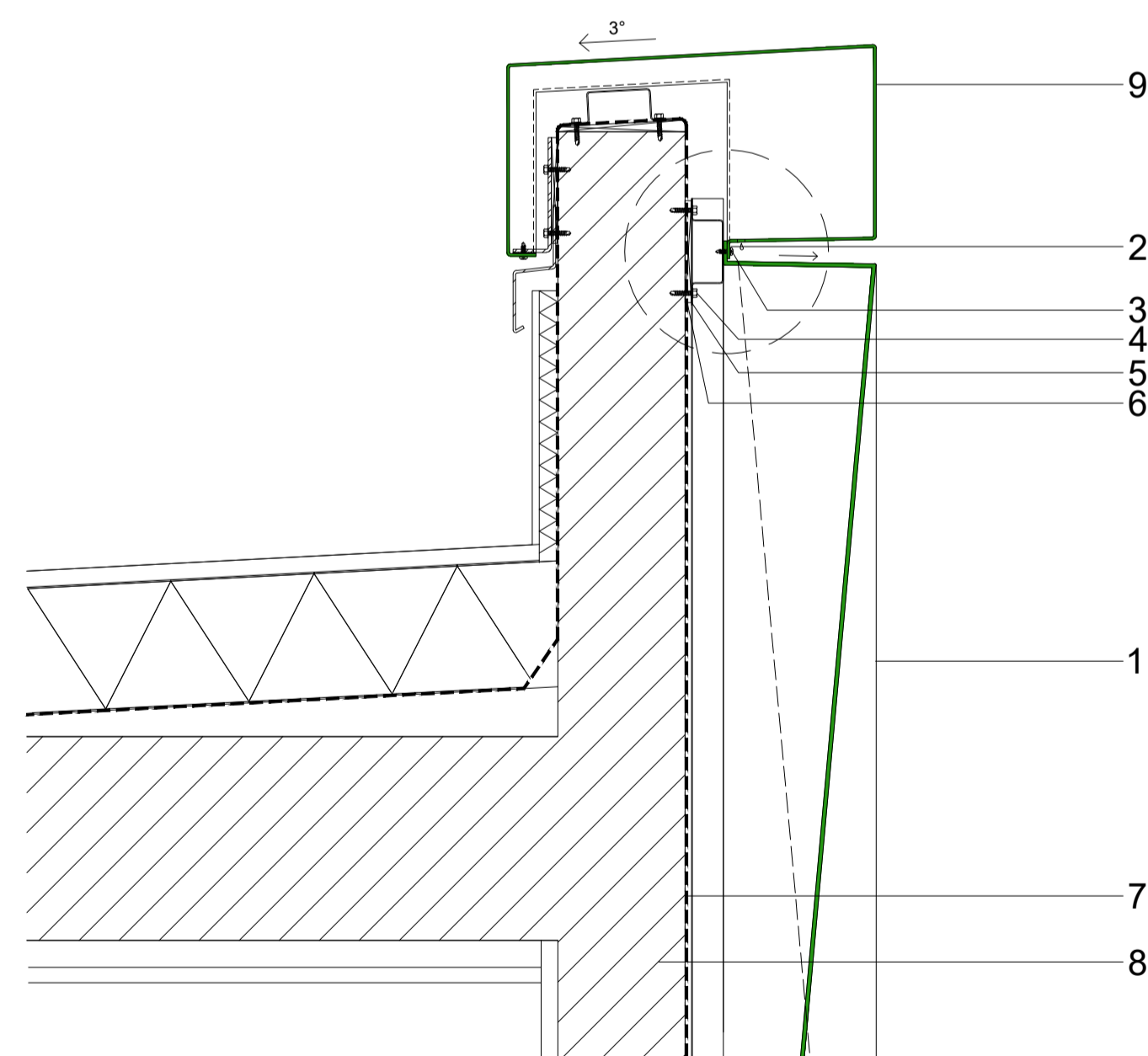

TEGO® Parapet Capping
1 : 5

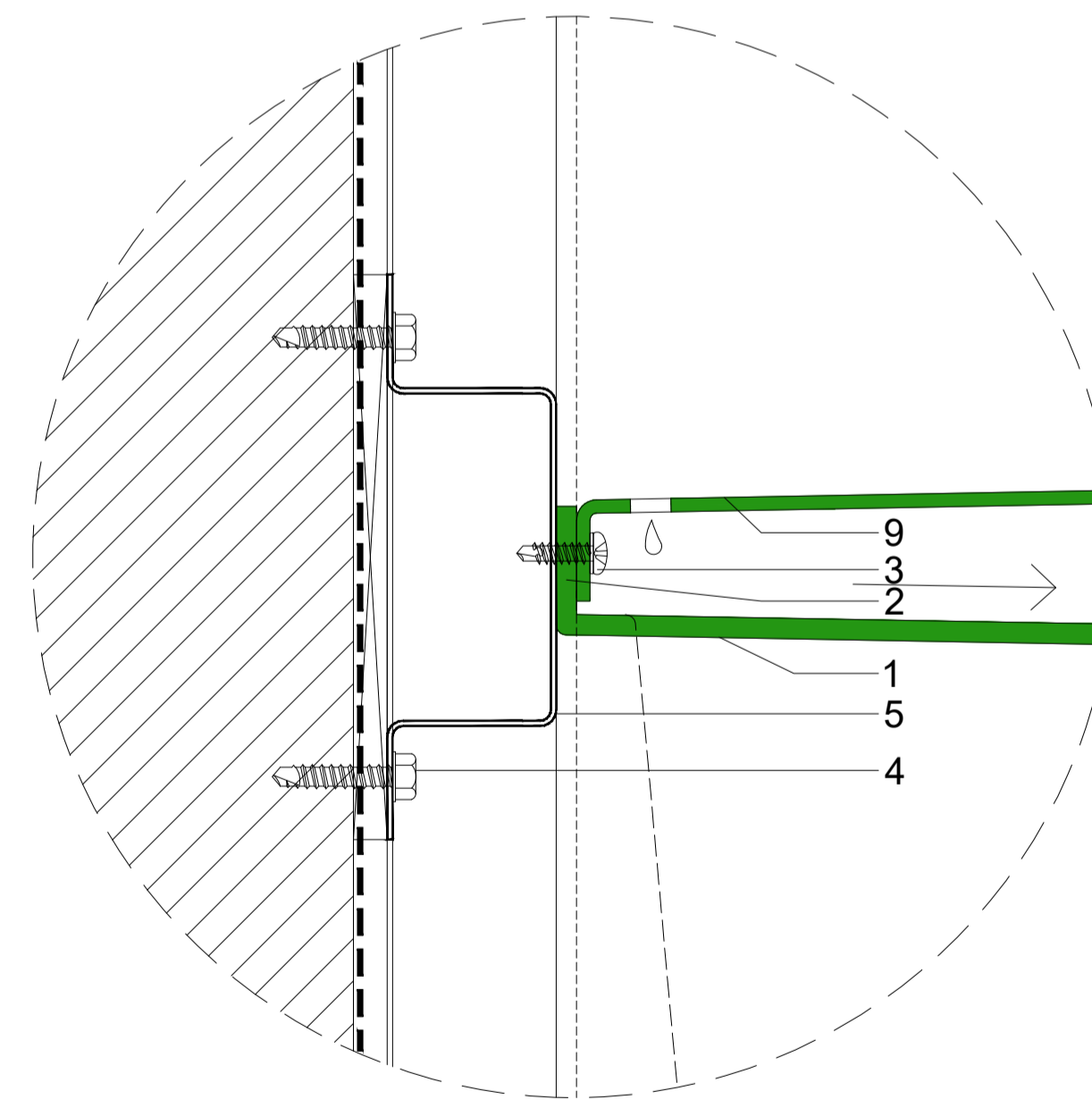

TEGO® Parapet Capping Detail
1 : 1

NOTE:
All design related drawings and concepts are property of SOLIDAL®.
Protected under Copyright Law.

PAGE:

2

DWG NAME:

SOLIDAL® TEGO® Oblique
Parapet Capping Detail

SCALE:

1 : 1 @ A1

DATE:

20 / MAR / 2023

TEGO®

SOLIDAL®

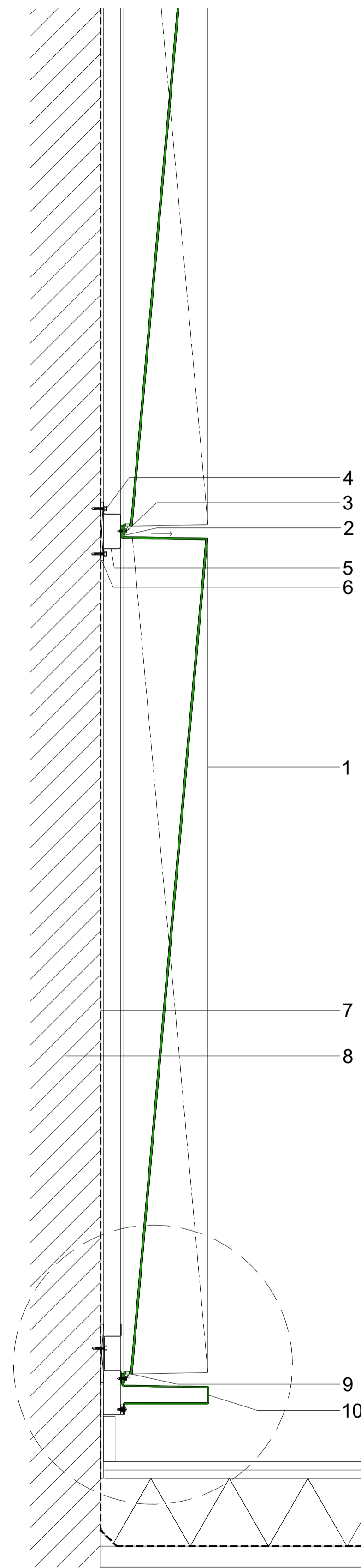

○ TEGO® Base Wall
1 : 5

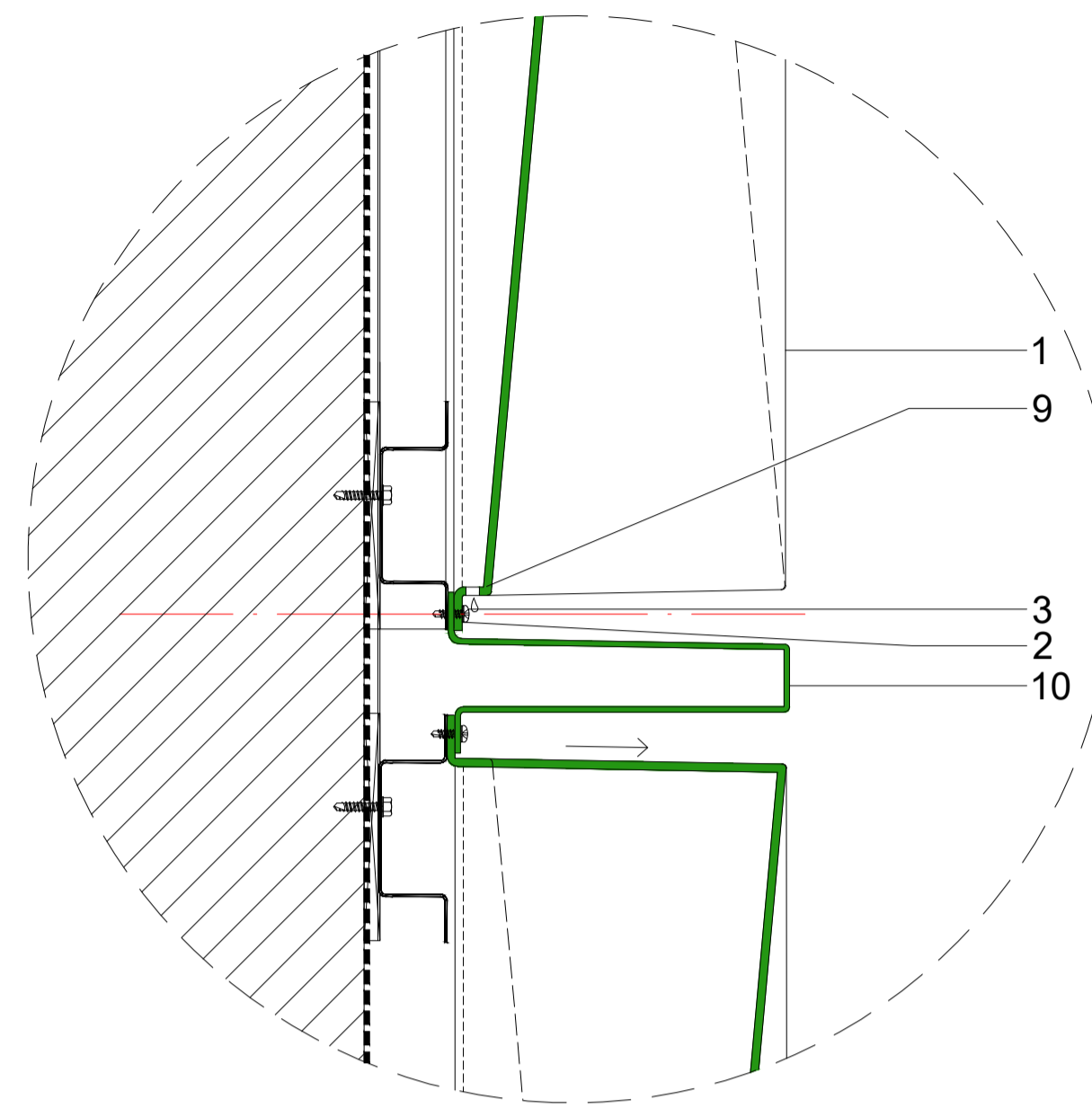

○ TEGO® Starter & Abutment (SA) Module - between TEGO® Modules
1 : 2

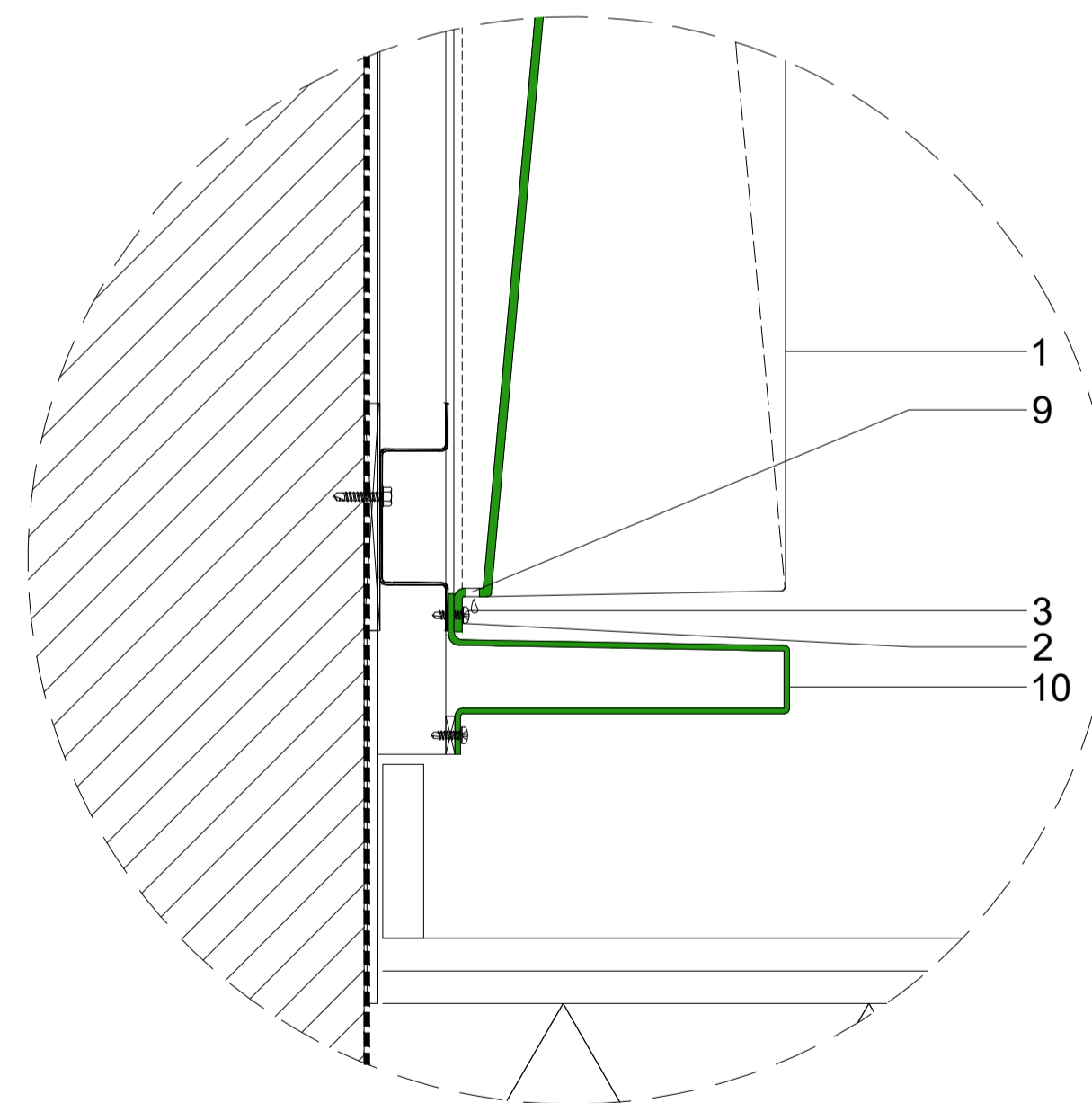

○ TEGO® Starter & Abutment (SA) Module - Base of the wall
1 : 2

SOLIDAL® TEGO®
Base Wall - Typical Detail

- 1 SOLIDAL® TEGO® Module (T3® Solid Aluminium)
- 2 SOLIDAL® Double-fold
- 3 Tek screw type 1
- 4 Tek screw type 2
- 5 Top hat
- 6 Packing as required
- 7 Weather seal layer
- 8 Building structure
- 9 Weep Hole
- 10 SOLIDAL® TEGO® SA (Starter & Abutment) Module.
T2® Solid Aluminium. Refer to SOLIDAL® Accessories Brochure.

NOTE:

All design related drawings and concepts are property of SOLIDAL®.
Protected under Copyright Law.

PAGE:

3

DWG NAME:

SOLIDAL® TEGO® Oblique
Base Wall Detail

SCALE:

1 : 1 @ A1

DATE:

20 / MAR / 2023

TEGO®

SOLIDAL®

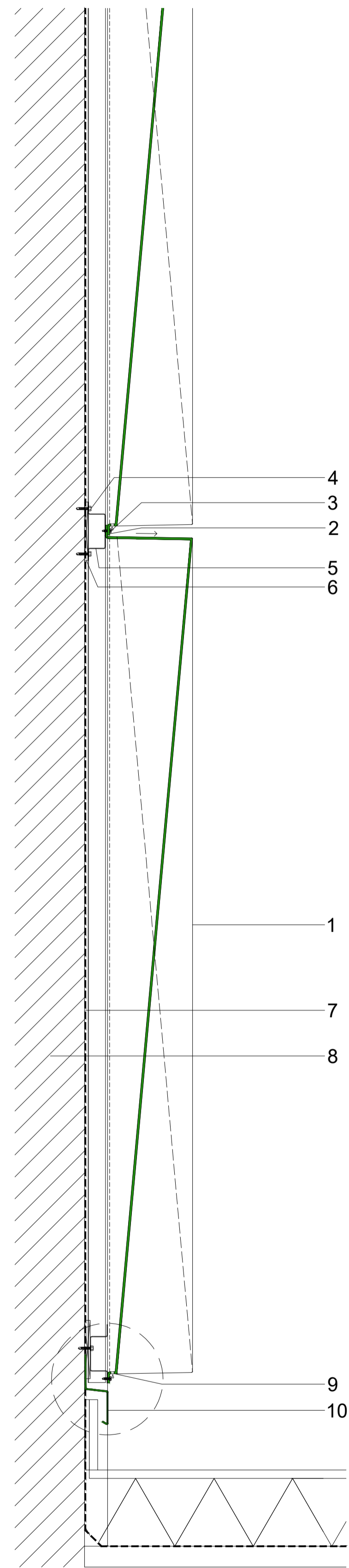

○ TEGO® Base Wall
1 : 5

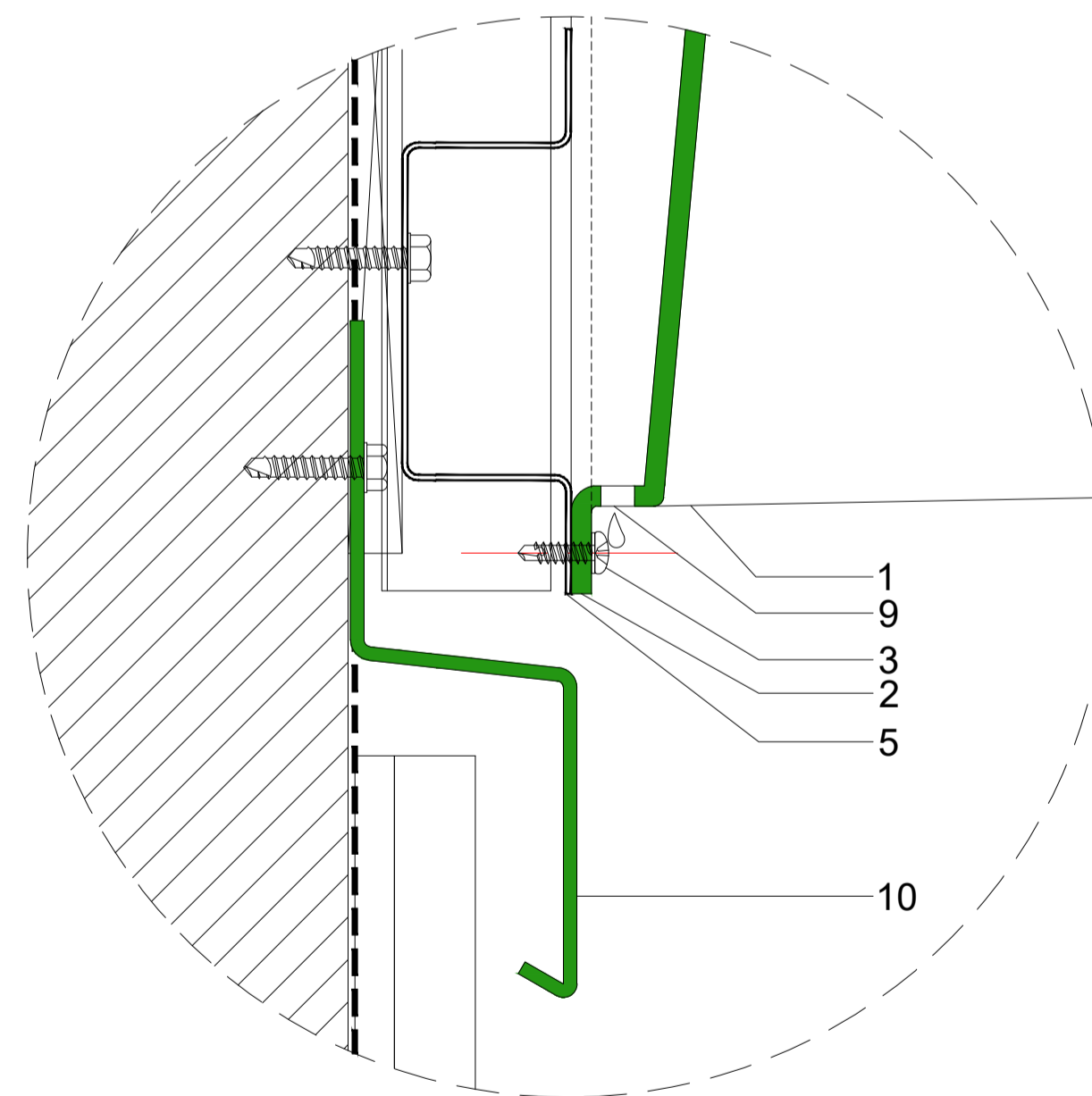

○ TEGO® Starter & Abutment (SA) Module
1 : 1

SOLIDAL® TEGO®
Base Wall - Typical Detail

- 1 SOLIDAL® TEGO® Module (T3® Solid Aluminium)
- 2 SOLIDAL® Double-fold
- 3 Tek screw type 1
- 4 Tek screw type 2
- 5 Top hat
- 6 Packing as required
- 7 Weather seal layer
- 8 Building structure
- 9 Weep Hole
- 10 SOLIDAL® TEGO® SA (Starter & Abutment) Module.
T2® Solid Aluminium. Refer to SOLIDAL® Accessories Brochure.

NOTE:

All design related drawings and concepts are property of SOLIDAL®.
Protected under Copyright Law.

PAGE:

4

DWG NAME:

SOLIDAL® TEGO® Oblique
Base Wall Detail

SCALE:

1 : 1 @ A1

DATE:

20 / MAR / 2023

TEGO®

SOLIDAL®

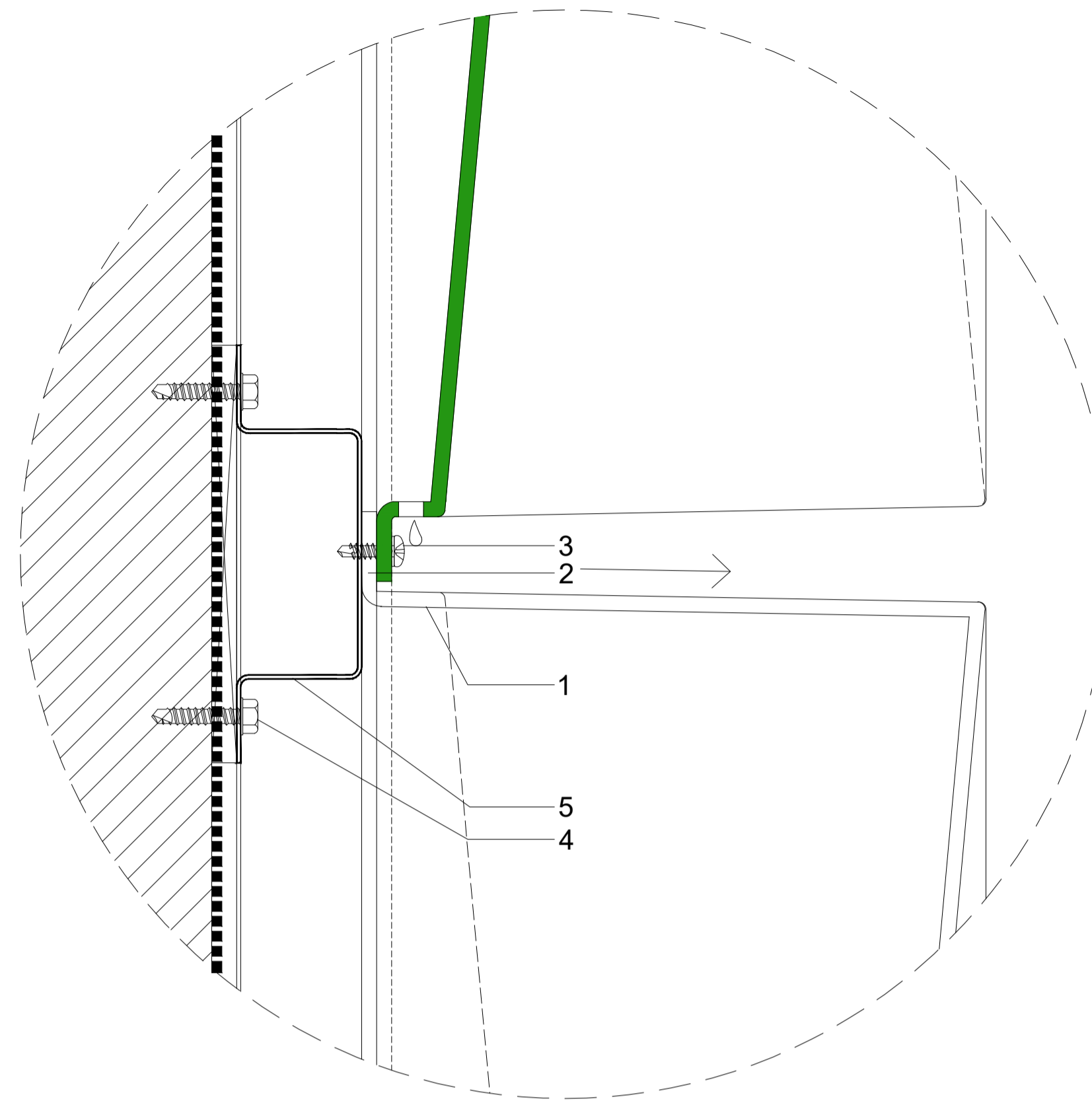
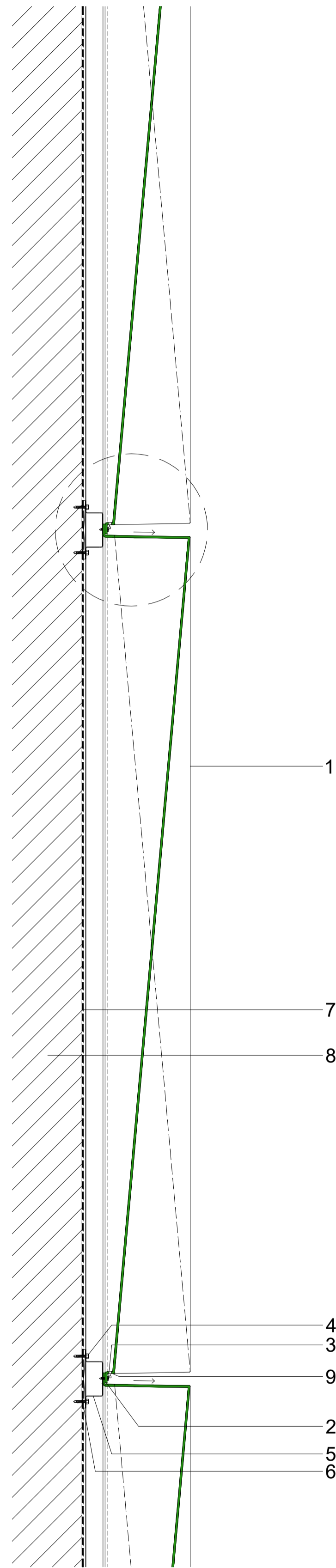

TEGO® Horizontal Joint Detail
 1 : 1

SOLIDAL® TEGO®
 Horizontal Joint - Typical Detail

- 1 SOLIDAL® TEGO® (T3®Solid Aluminium)
- 2 SOLIDAL® Double fold
- 3 Tek screw type 1
- 4 Tek screw type 2
- 5 Top hat
- 6 Packing as required
- 7 Weather seal layer
- 8 Building structure
- 9 Weep Hole

TEGO® Horizontal Joint
 1 : 5

NOTE:

All design related drawings and concepts are property of SOLIDAL®.
Protected under Copyright Law.

PAGE:

5

DWG NAME:

SOLIDAL® TEGO® Oblique
Horizontal Joint Detail

SCALE:

1 : 1 @ A1

DATE:

20 / MAR / 2023

TEGO®

SOLIDAL®

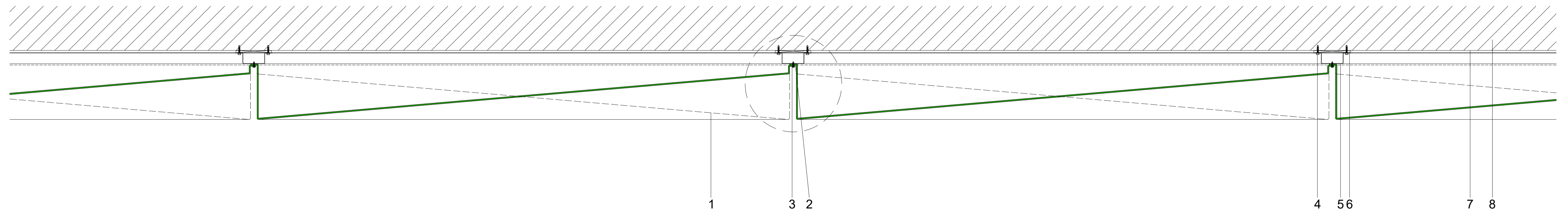

TEGO® Vertical Joint
 1 : 5

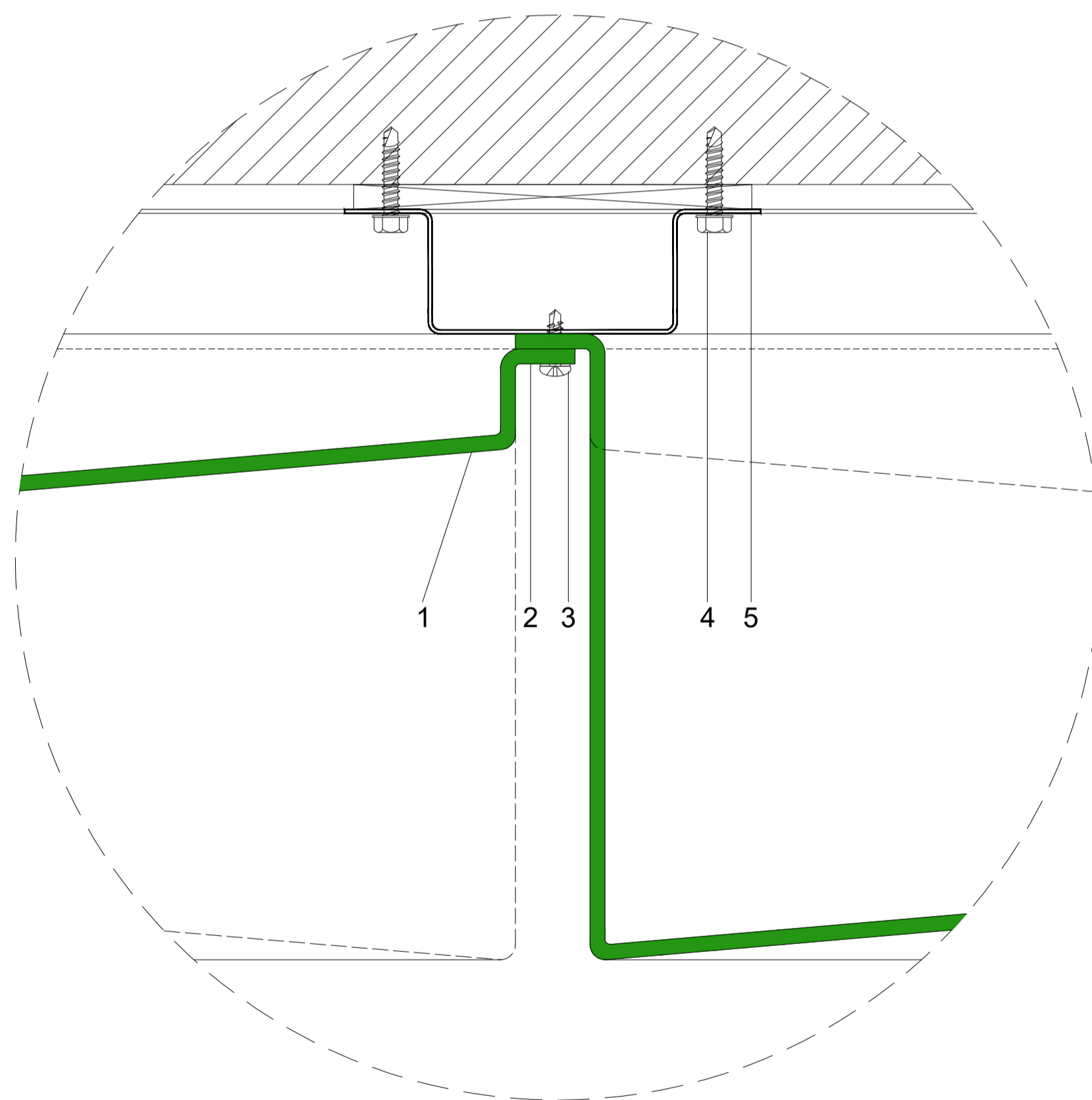

SOLIDAL® TEGO®
 Vertical Joint - Typical Detail

- 1 SOLIDAL® TEGO® (T3®Solid Aluminium)
- 2 SOLIDAL® Double fold
- 3 Tek screw type 1
- 4 Tek screw type 2
- 5 Top hat
- 6 Packing as required
- 7 Weather seal layer
- 8 Building structure

TEGO® Vertical Joint Detail
 1 : 1

NOTE:

All design related drawings and concepts are property of SOLIDAL®.
Protected under Copyright Law.

PAGE:

6

DWG NAME:

SOLIDAL® TEGO® Oblique
Vertical Joint Detail

SCALE:

1 : 1 @ A1

DATE:

20 / MAR / 2023

TEGO®

SOLIDAL®

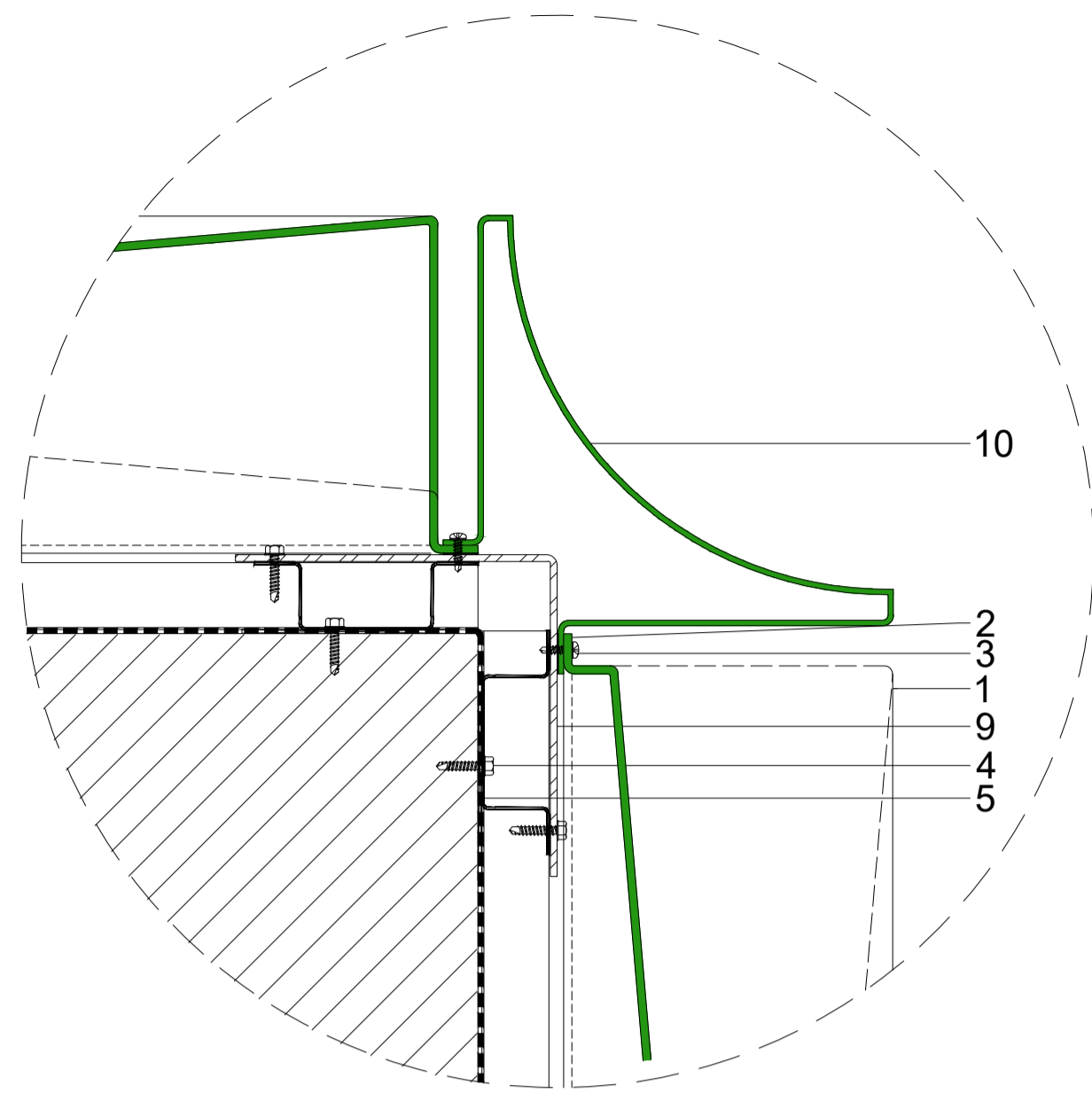

TEGO® External Corner (EC) Module
1 : 2

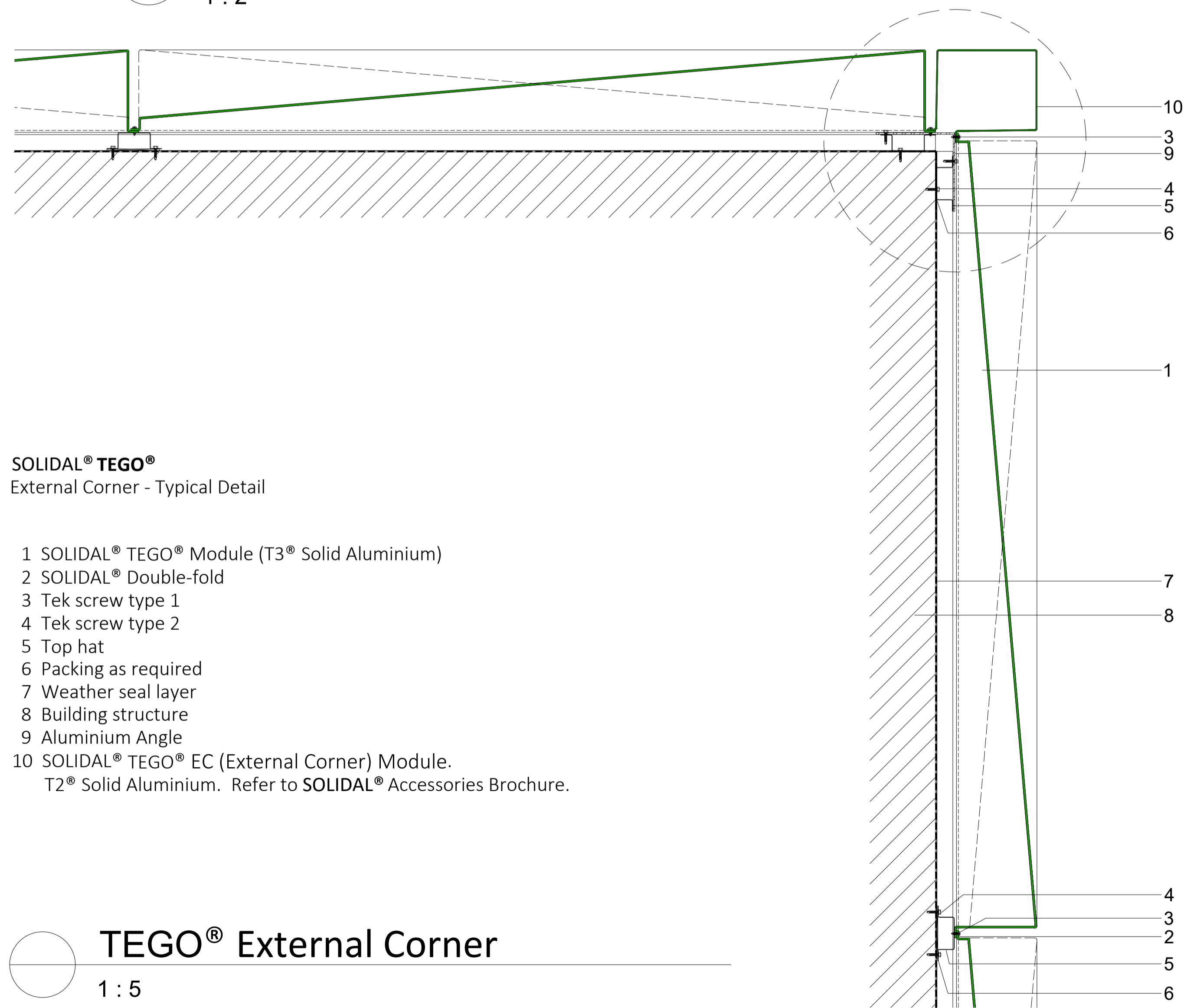

SOLIDAL® TEGO®
External Corner - Typical Detail

- 1 SOLIDAL® TEGO® Module (T3® Solid Aluminium)
- 2 SOLIDAL® Double-fold
- 3 Tek screw type 1
- 4 Tek screw type 2
- 5 Top hat
- 6 Packing as required
- 7 Weather seal layer
- 8 Building structure
- 9 Aluminium Angle
- 10 SOLIDAL® TEGO® EC (External Corner) Module.
T2® Solid Aluminium. Refer to SOLIDAL® Accessories Brochure.

TEGO® External Corner
1 : 5

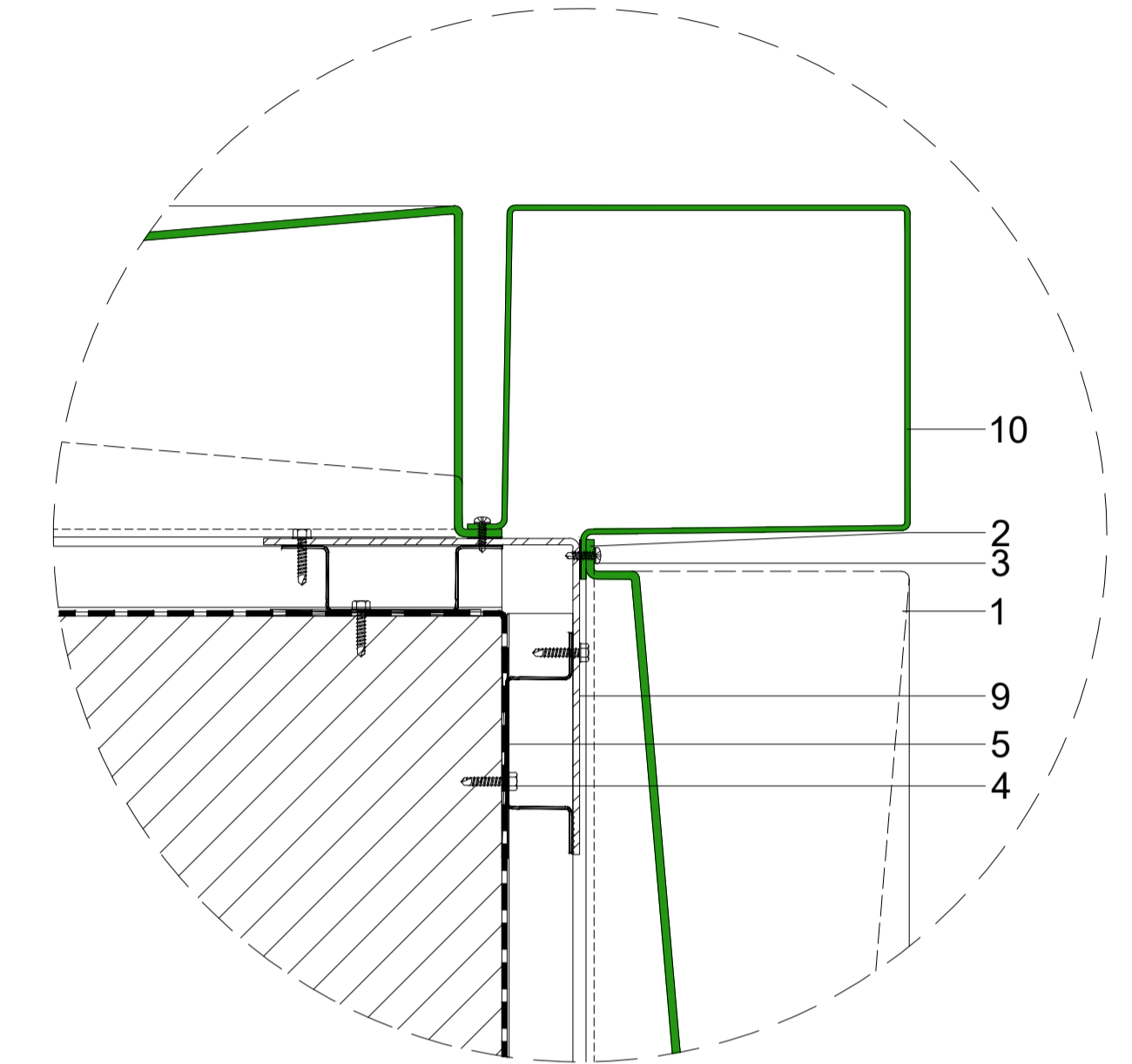

TEGO® External Corner - Optional Detail 1
1 : 2

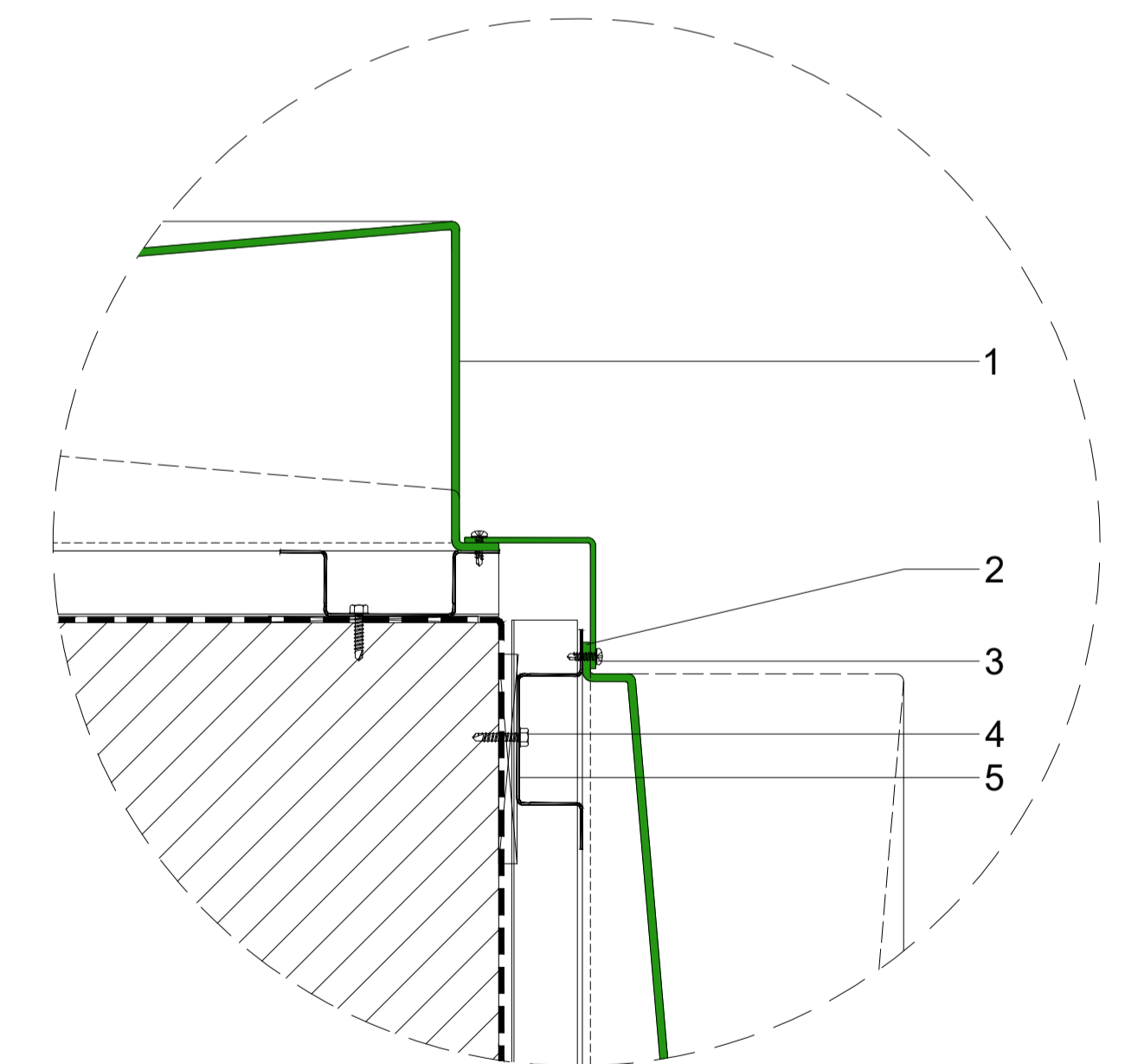

TEGO® External Corner - Optional Detail 2
1 : 2

NOTE:

All design related drawings and concepts are property of SOLIDAL®.
Protected under Copyright Law.

PAGE:

7

DWG NAME:

SOLIDAL® TEGO® Oblique
External Corner Detail

SCALE:

1 : 1 @ A1

DATE:

20 / MAR / 2023

TEGO®

SOLIDAL®

SOLIDAL® TEGO®
Typical Soffit Detail

- 1 SOLIDAL® TEGO® Module (T3® Solid Aluminium)
- 2 SOLIDAL® Double-fold
- 3 Tek screw type 1
- 4 Tek screw type 2
- 5 Top hat
- 6 Packing as required
- 7 Weather seal layer
- 8 Building structure
- 9 Aluminium Angle 120x120mm
- 10 SOLIDAL® TEGO® EC (External Corner) Module.
T2® Solid Aluminium. Refer to SOLIDAL® Accessories Brochure.

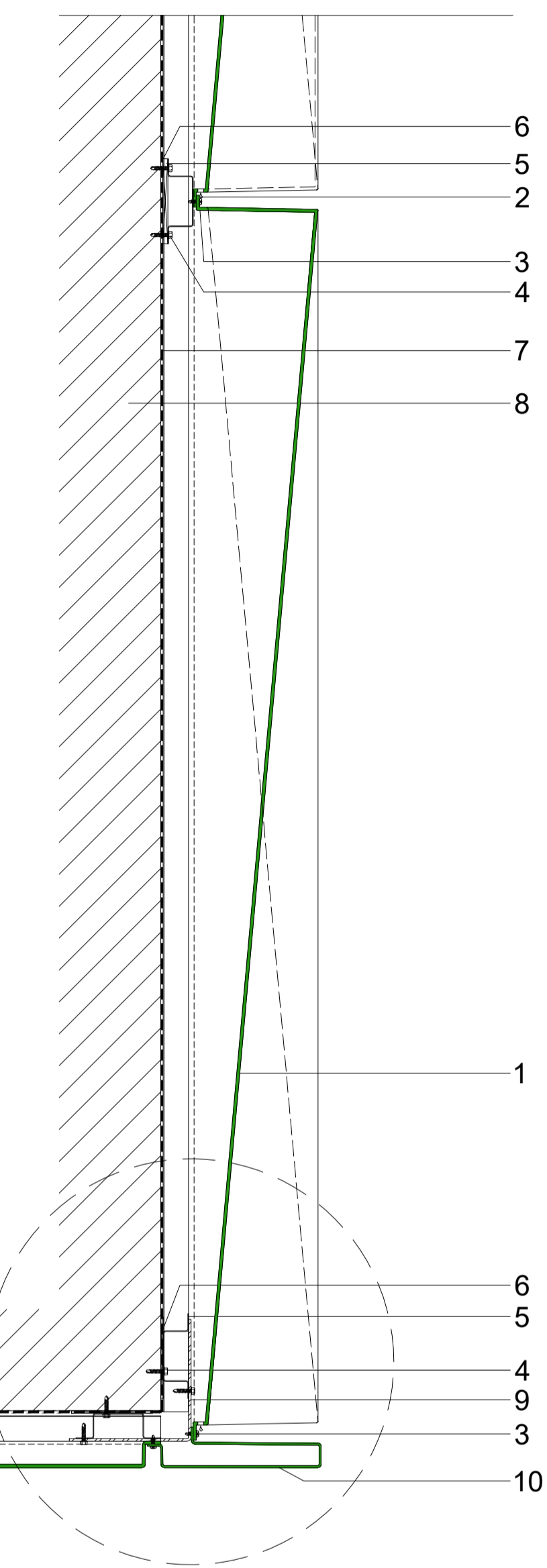

TEGO® Soffit Detail

1 : 5

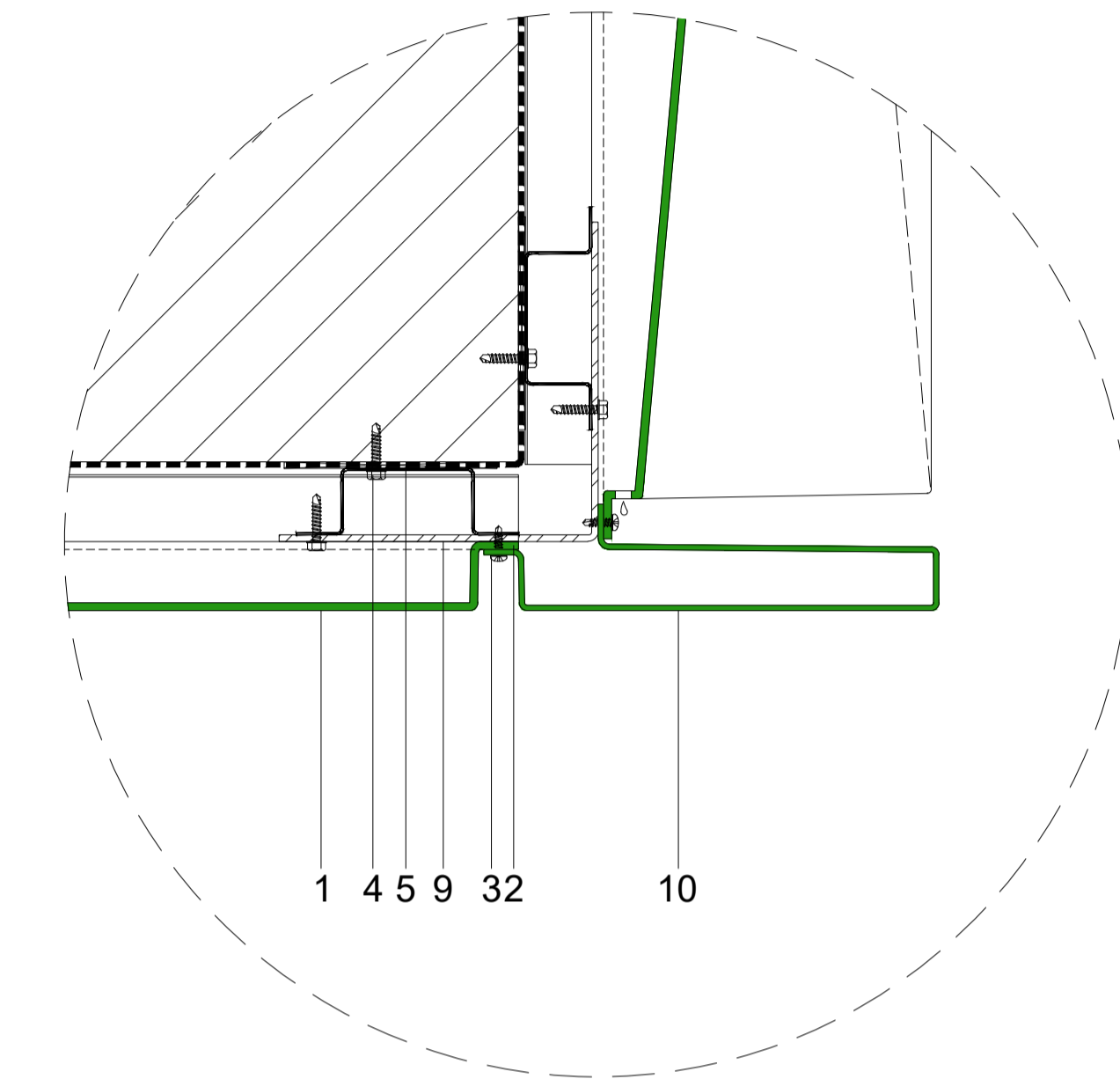

TEGO® Soffit Detail with External Corner (EC) Module
1 : 2

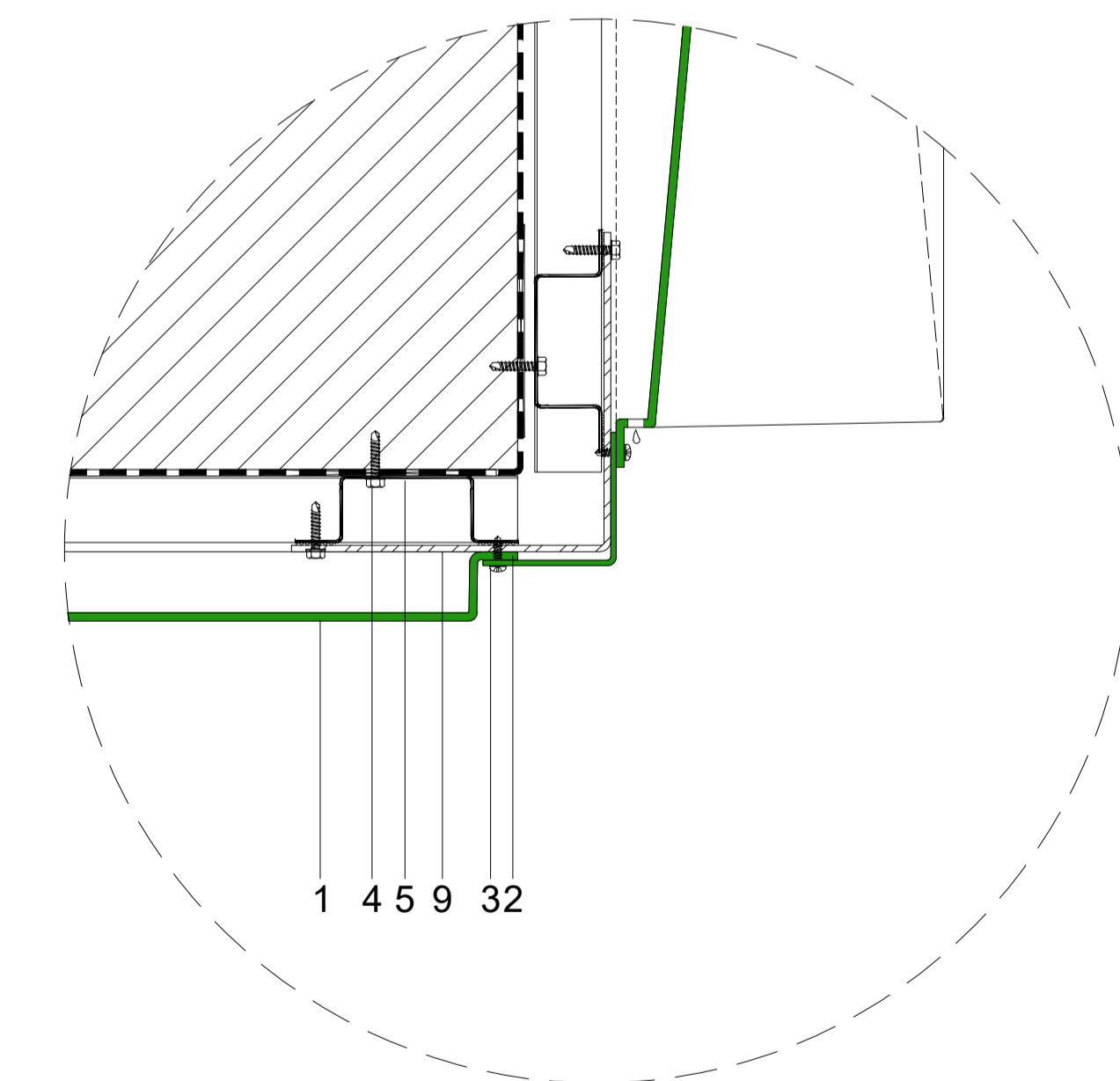

TEGO® Soffit - Optional Detail
1 : 2

NOTE:
All design related drawings and concepts are property of SOLIDAL®.
Protected under Copyright Law.

PAGE:

8

DWG NAME:

SOLIDAL® TEGO® Oblique
Soffit Detail

SCALE:

1 : 1 @ A1

DATE:

20 / MAR / 2023

TEGO®

SOLIDAL®

SOLIDAL® TEGO®
Typical Soffit Detail

- 1 SOLIDAL® TEGO® Module (T3® Solid Aluminium)
- 2 SOLIDAL® Double-fold
- 3 Tek screw type 1
- 4 Tek screw type 2
- 5 Top hat
- 6 Packing as required
- 7 Weather seal layer
- 8 Building structure
- 9 Aluminium Angle 120x120mm
- 10 SOLIDAL® TEGO® EC (External Corner) Module.
T2® Solid Aluminium. Refer to SOLIDAL® Accessories Brochure.

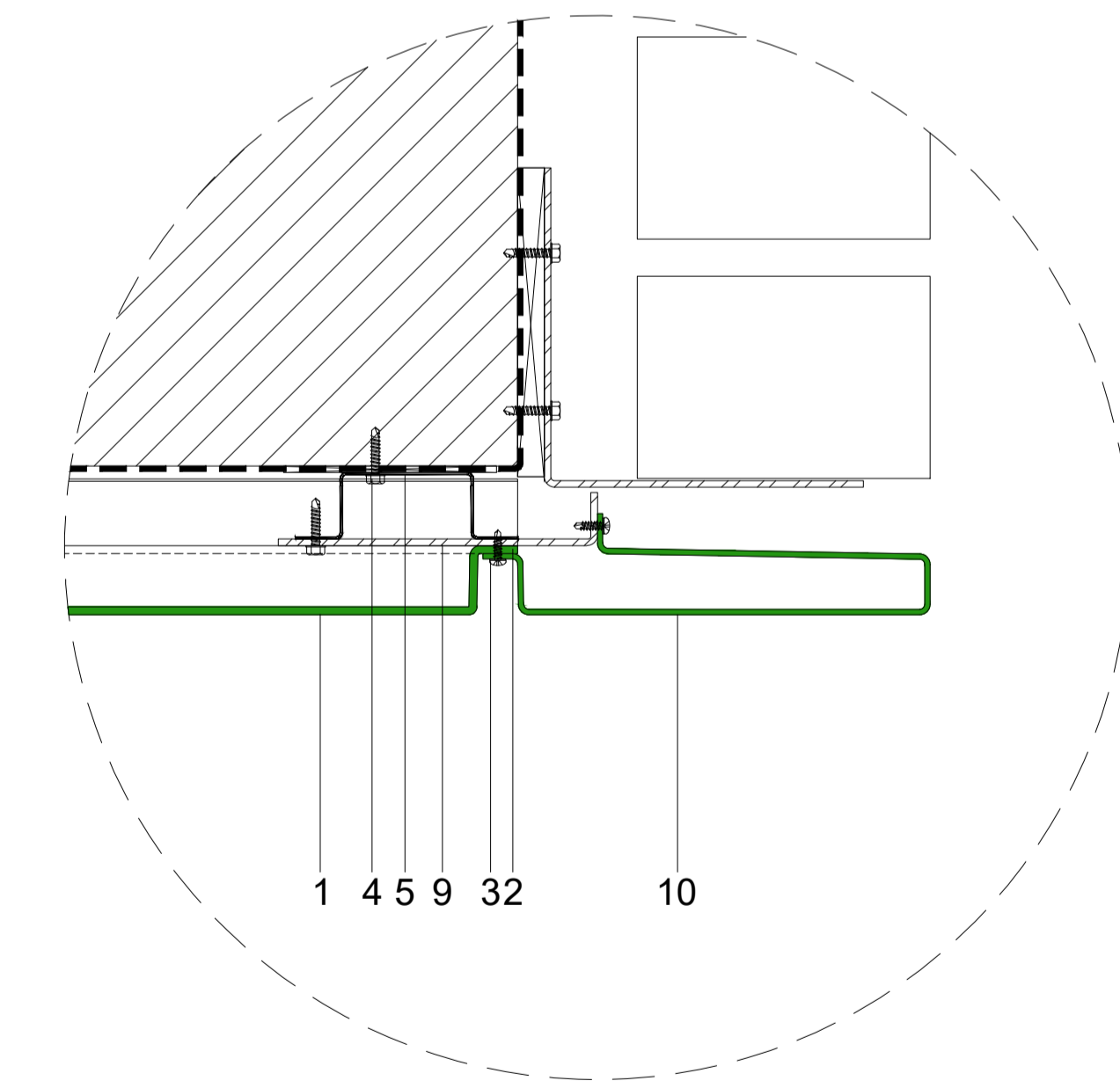
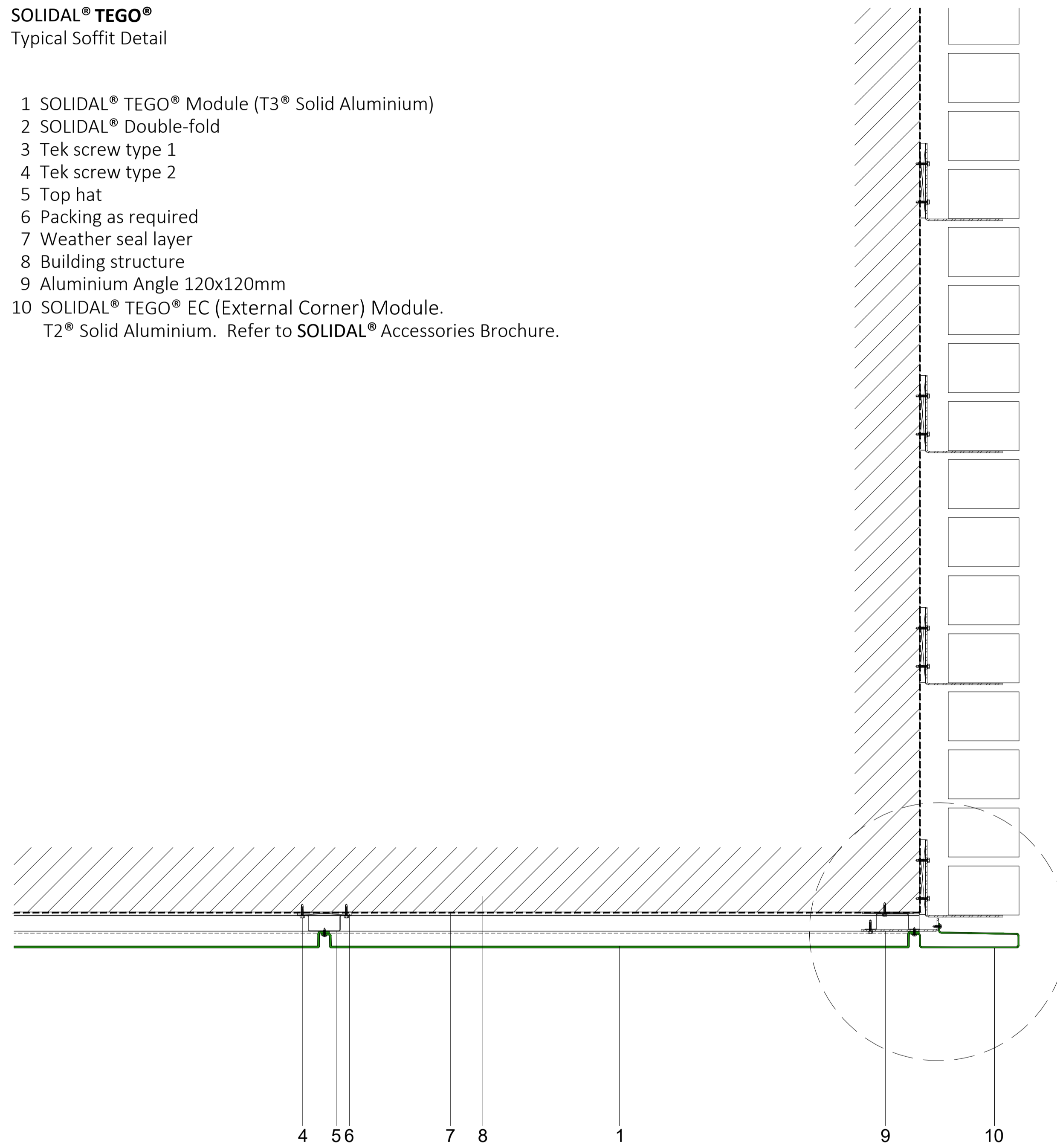

○ TEGO® Soffit Detail
1 : 5

○ TEGO® Soffit Detail with External Corner (EC) Module
1 : 2

NOTE:

All design related drawings and concepts are property of SOLIDAL®.
Protected under Copyright Law.

PAGE:

9

DWG NAME:

SOLIDAL® TEGO® Oblique
Soffit Detail

SCALE:

1 : 1 @ A1

DATE:

20 / MAR / 2023

TEGO®

SOLIDAL®

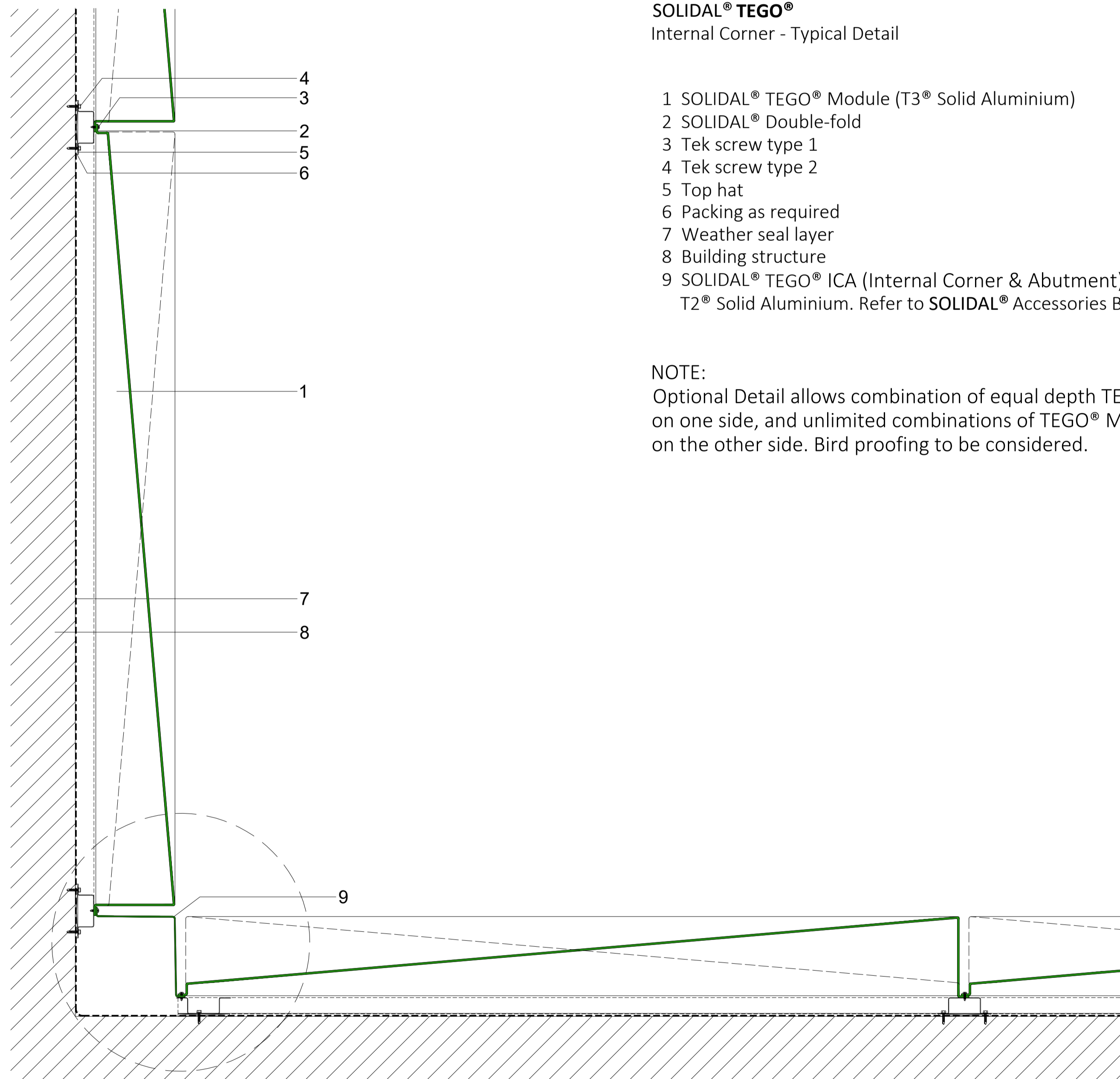

SOLIDAL® TEGO®
Internal Corner - Typical Detail

- 1 SOLIDAL® TEGO® Module (T3® Solid Aluminium)
- 2 SOLIDAL® Double-fold
- 3 Tek screw type 1
- 4 Tek screw type 2
- 5 Top hat
- 6 Packing as required
- 7 Weather seal layer
- 8 Building structure
- 9 SOLIDAL® TEGO® ICA (Internal Corner & Abutment) Module. T2® Solid Aluminium. Refer to SOLIDAL® Accessories Brochure.

NOTE:
Optional Detail allows combination of equal depth TEGO® Modules on one side, and unlimited combinations of TEGO® Modules on the other side. Bird proofing to be considered.

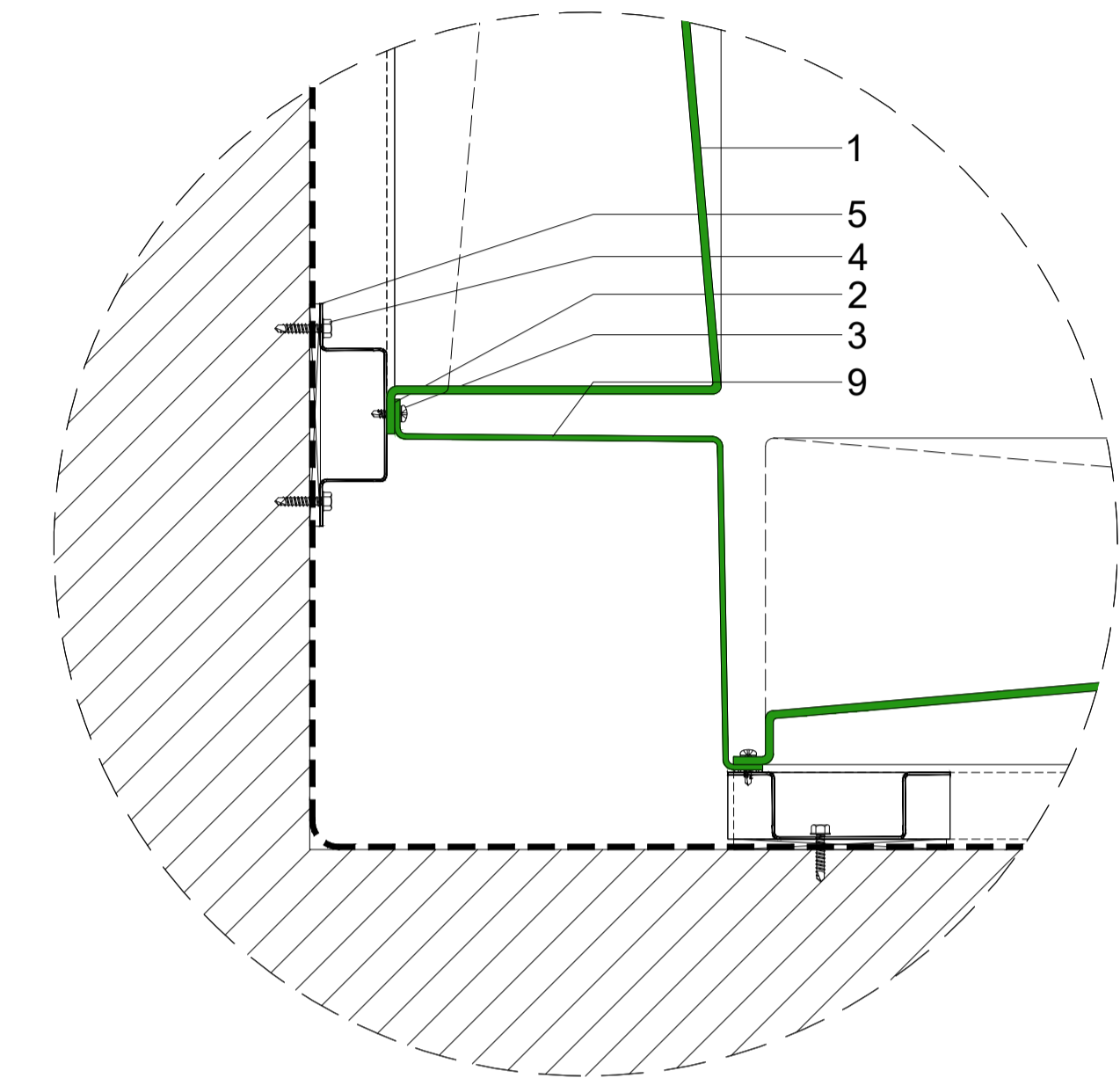

○ TEGO® Internal Corner & Abutment (ICA) Module
1 : 2

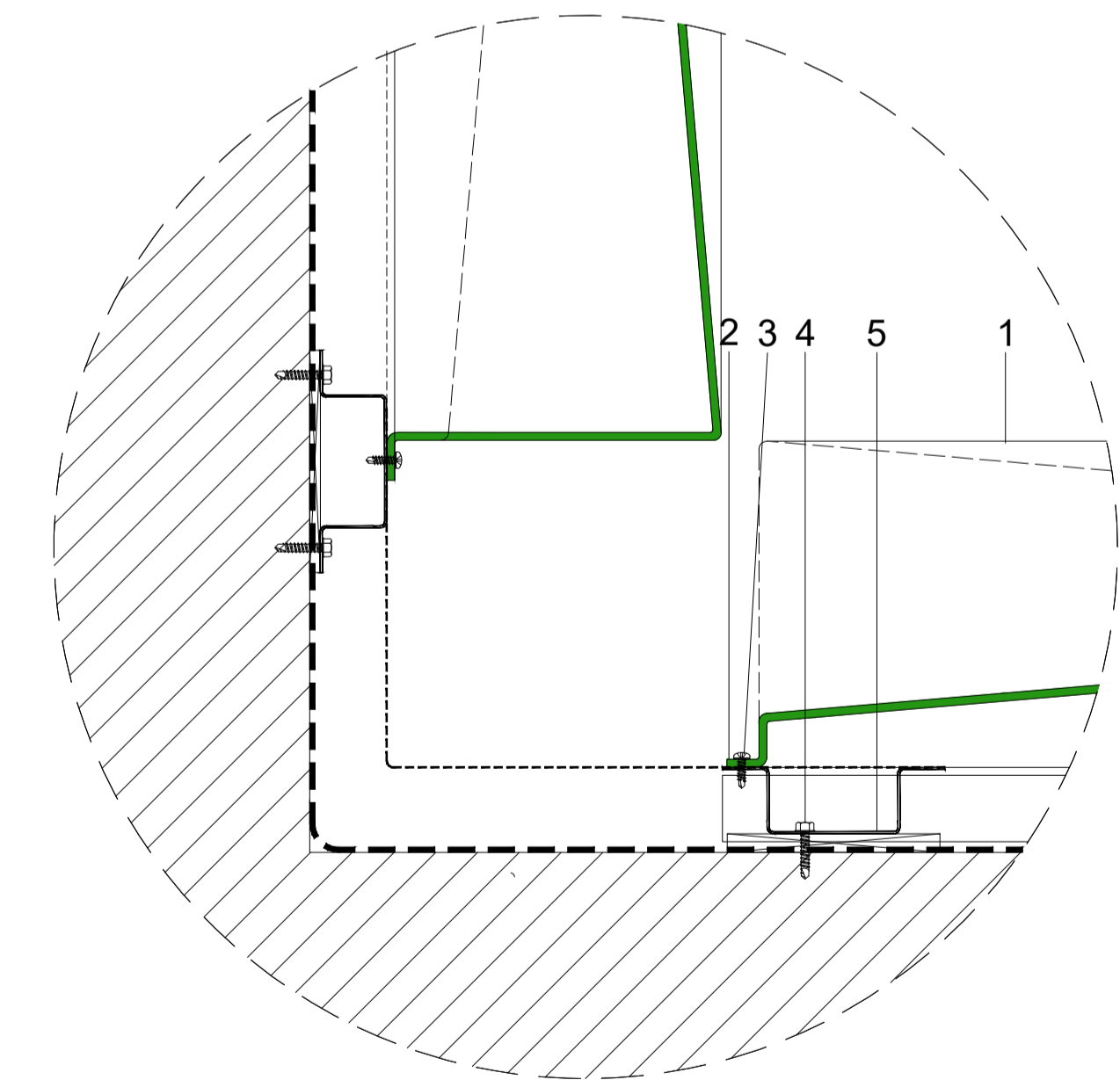

○ TEGO® Internal Corner - Optional Detail
1 : 2

○ TEGO® Internal Corner
1 : 5

NOTE:
All design related drawings and concepts are property of SOLIDAL®.
Protected under Copyright Law.

PAGE:

10

DWG NAME:

SOLIDAL® TEGO® Oblique
Internal Corner Detail

SCALE:

1 : 1 @ A1

DATE:

20 / MAR / 2023

TEGO®

SOLIDAL®

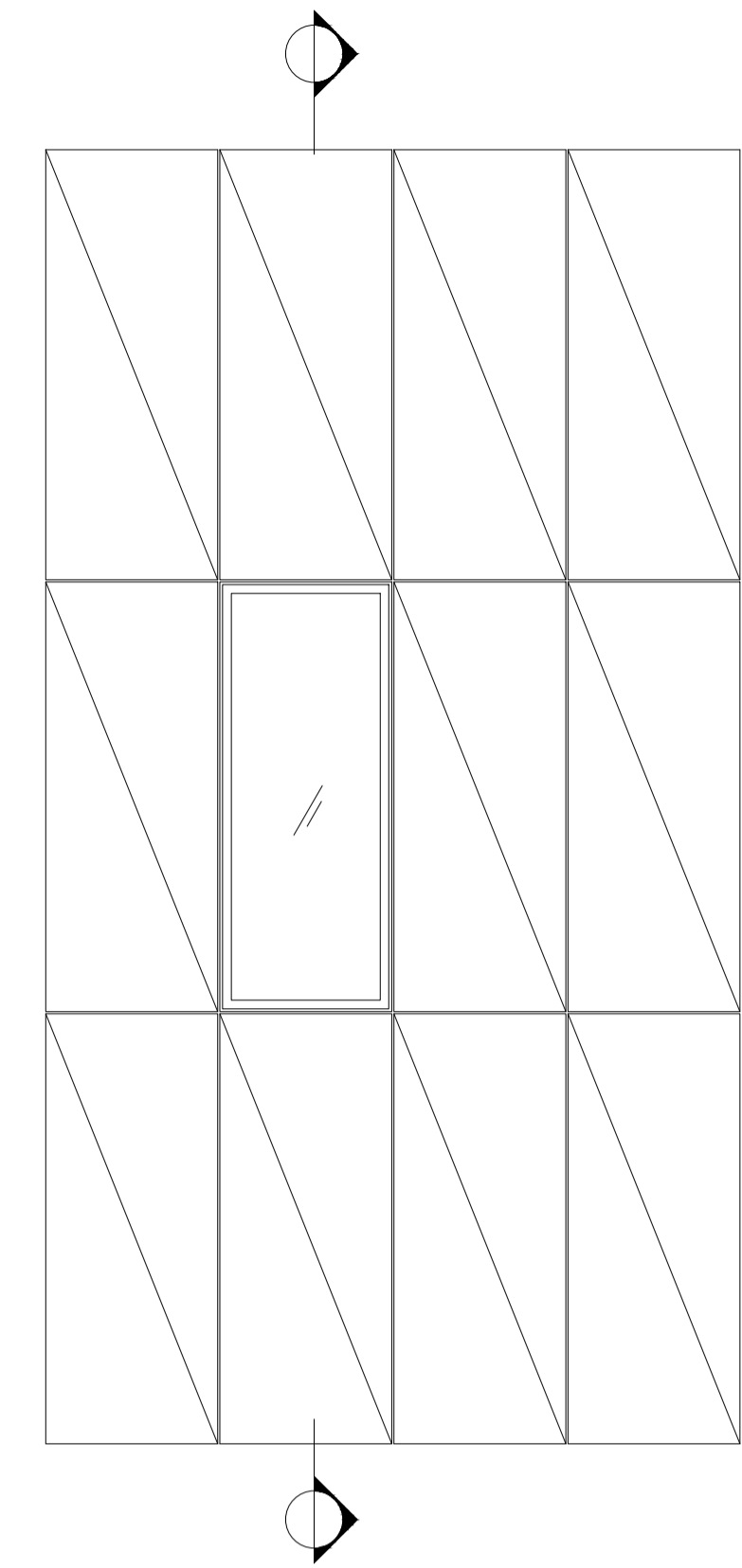
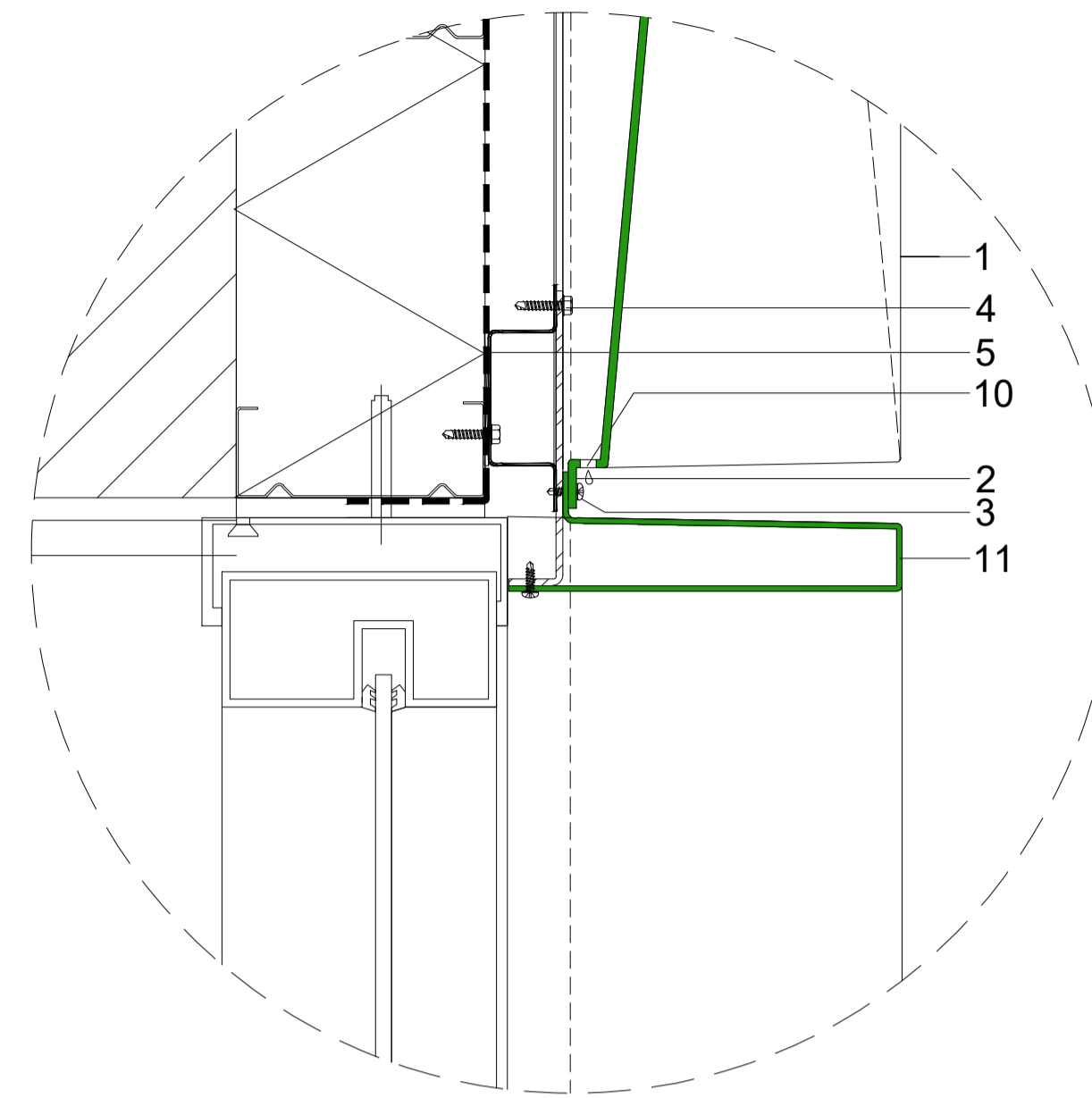
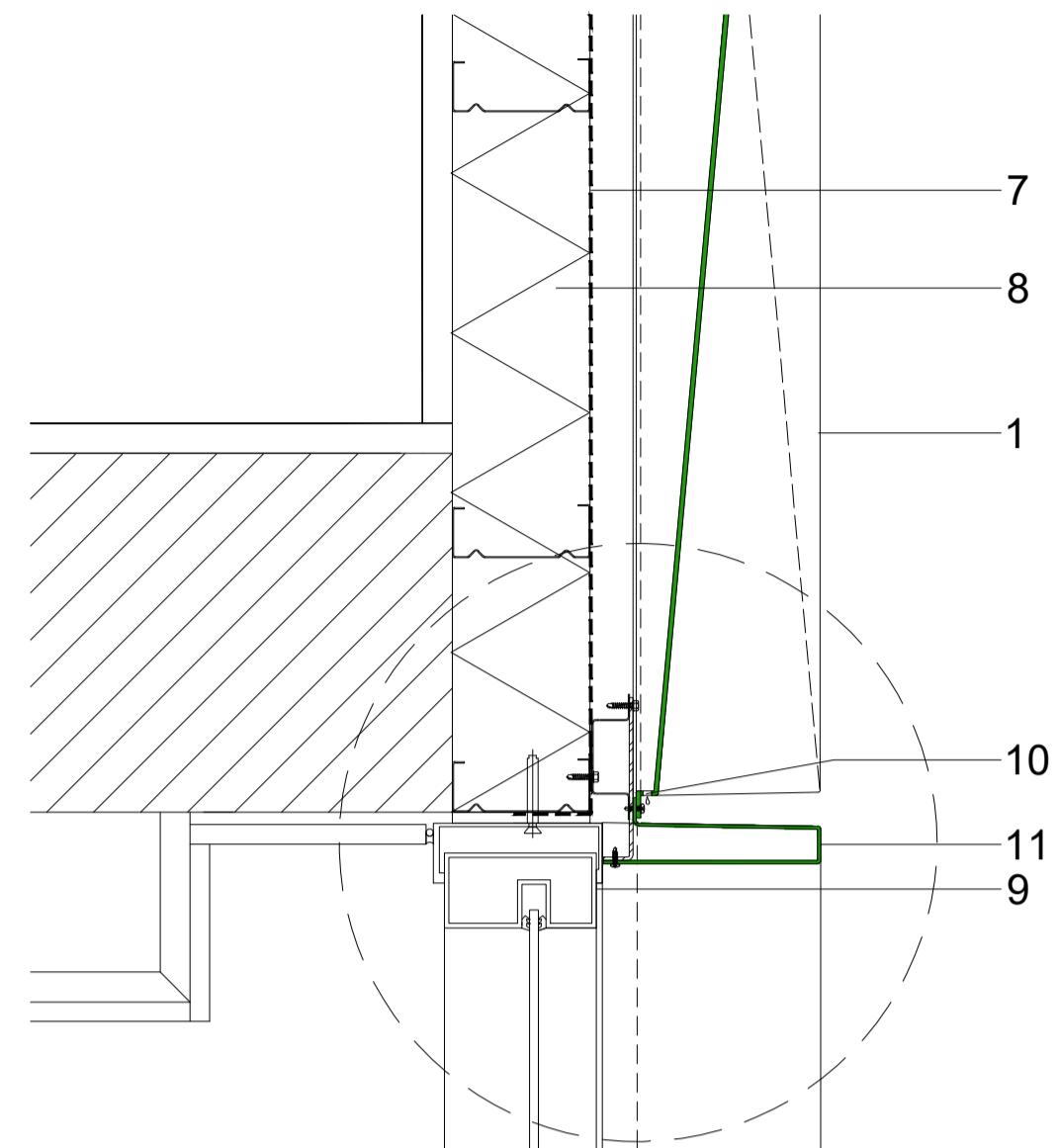

TEGO® Window Head (WH) Detail
1 : 2

TEGO® Setout Diagram

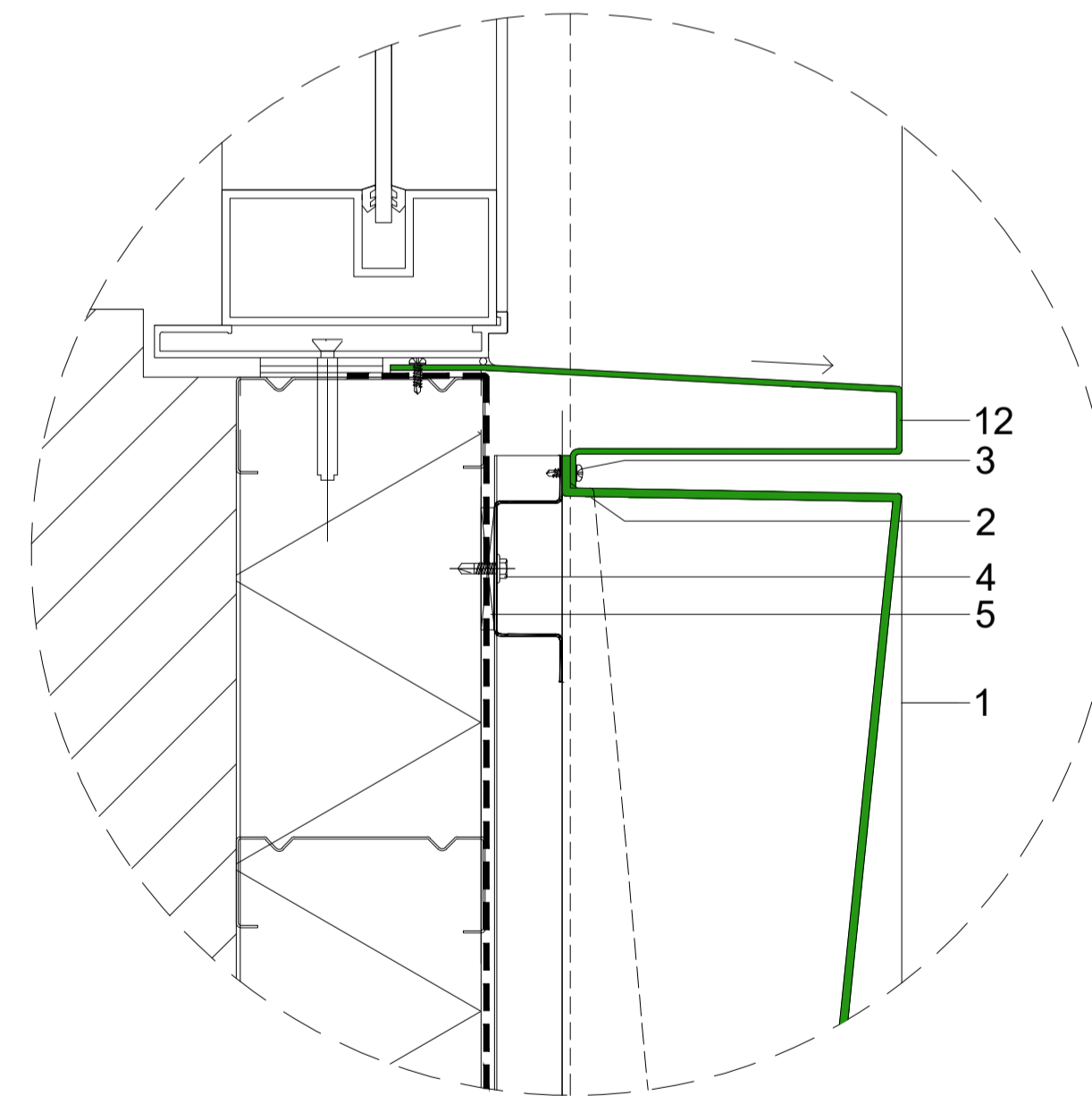
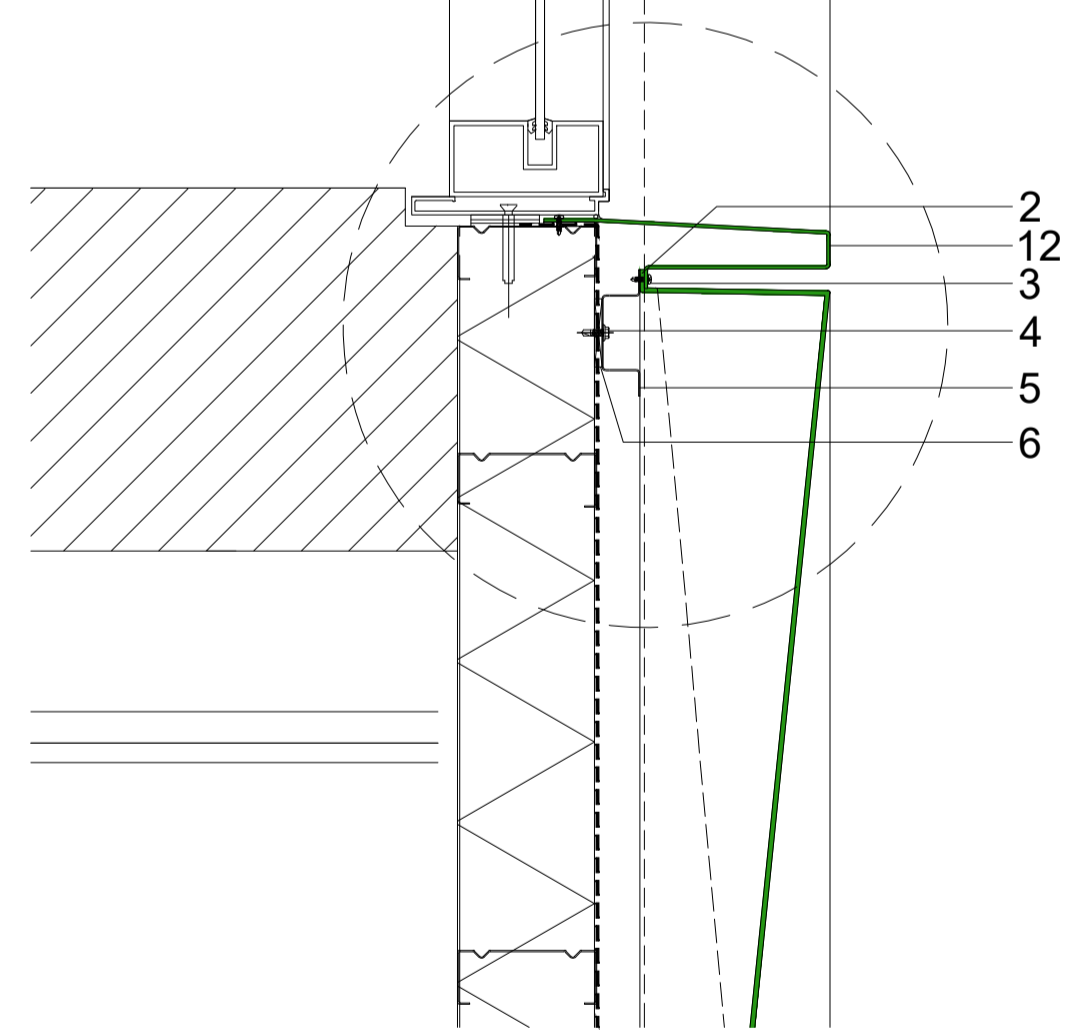

TEGO® Window Details
1 : 5

TEGO® Window Sill Detail (WS)
1 : 2

SOLIDAL® TEGO®
Window Details - Typical Details

- 1 SOLIDAL® TEGO® Module (T3® Solid Aluminium)
- 2 SOLIDAL® Double-fold
- 3 Tek screw type 1
- 4 Tek screw type 2
- 5 Top hat
- 6 Packing as required
- 7 Weather seal layer
- 8 Building structure
- 9 Window Frame
- 10 Weep Hole
- 11 SOLIDAL® WH (Window Head) Module.
For Window and Door Head.
- T2® Solid Aluminium. Refer to SOLIDAL® Accessories Brochure.
- 12 SOLIDAL® WS (Window Sill) Module.
T2® Solid Aluminium. Refer to SOLIDAL® Accessories Brochure.

NOTE:

All design related drawings and concepts are property of SOLIDAL®.
Protected under Copyright Law.

PAGE:

11

DWG NAME:

SOLIDAL® TEGO® Oblique
Window Head and Sill Detail

SCALE:

1 : 1 @ A1

DATE:

20 / MAR / 2023

TEGO®

SOLIDAL®

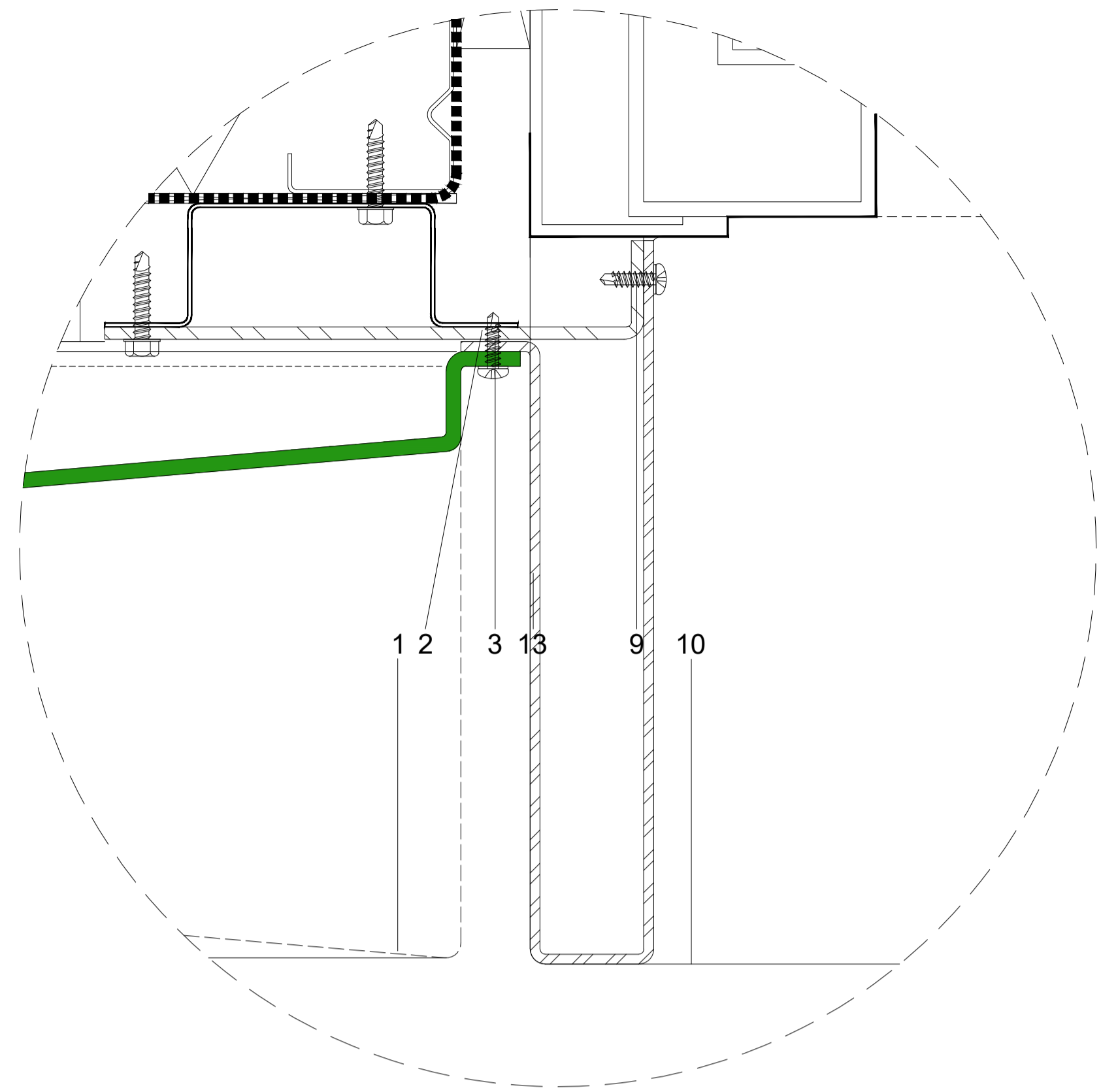

TEGO® Window Jamb Left (WJR)
1 : 2

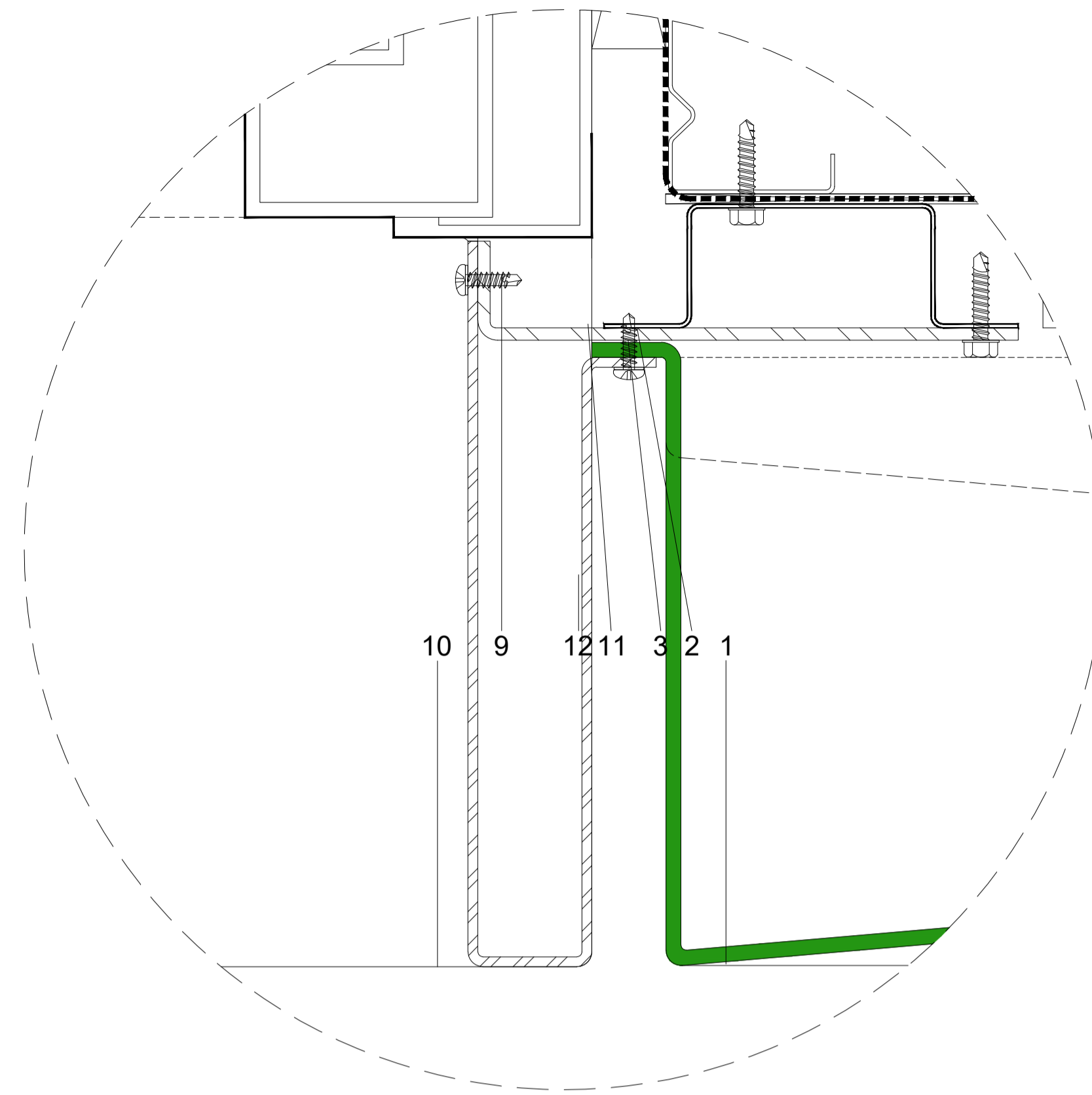

TEGO® Window Jamb Right (WJR)
1 : 2

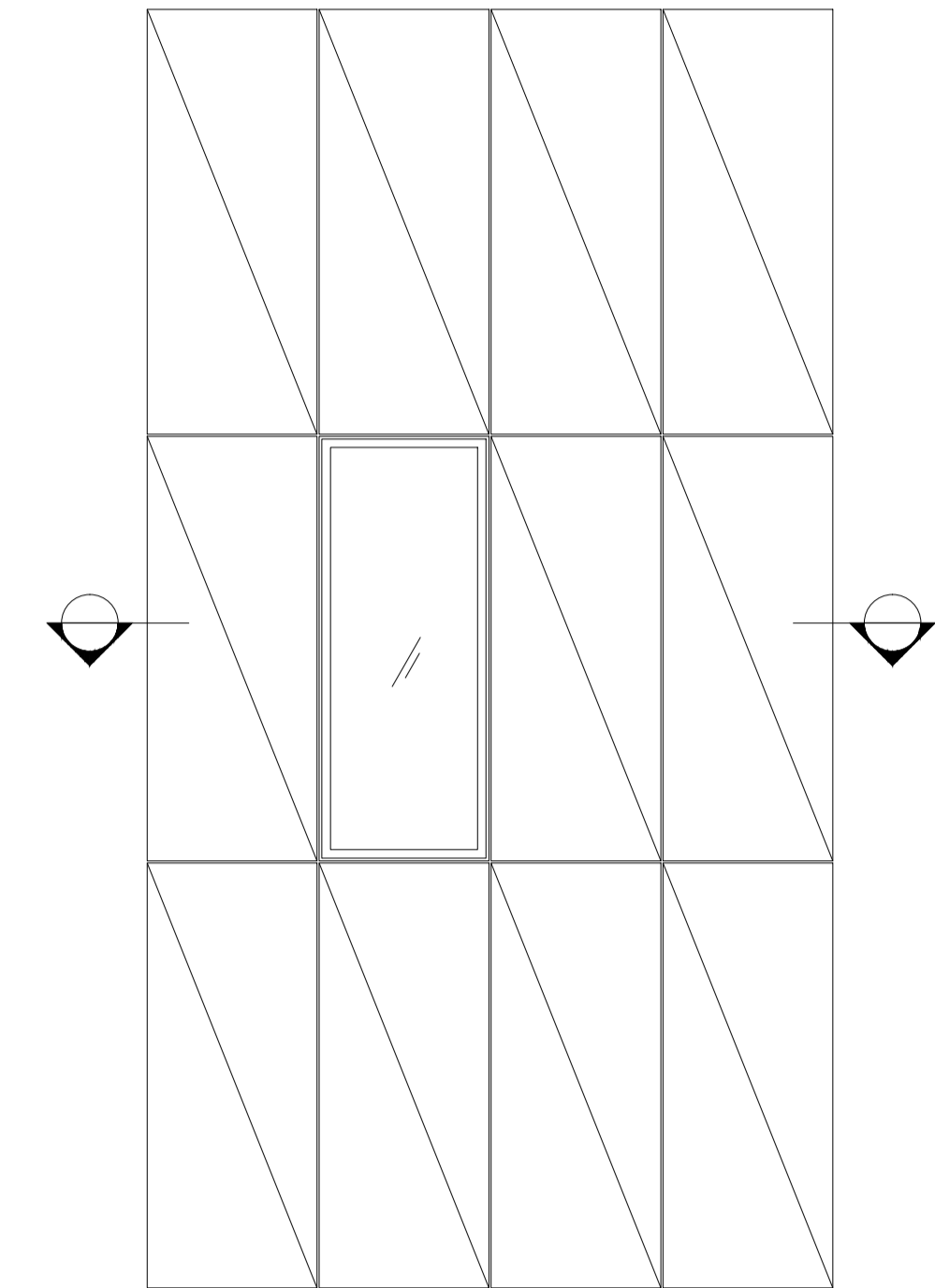

TEGO® Setout Diagram

**SOLIDAL® TEGO®
Window Jamb**

- 1 SOLIDAL® TEGO® Module (T3® Solid Aluminium)
- 2 SOLIDAL® Double-fold
- 3 Tek screw type 1
- 4 Tek screw type 2
- 5 Top hat
- 6 Packing as required
- 7 Weather seal layer
- 8 Building structure
- 9 Window Frame
- 10 SOLIDAL® TEGO® Window Sill (Type 1 or Type 2)
- 11 Aluminium Angle fixed in place
- 12 SOLIDAL® TEGO® JR (Window Jamb Right) Module.
- 13 SOLIDAL® TEGO® JL (Window Jamb Left) Module.
For Window and Door Jamb.
Refer to SOLIDAL® Accessories Brochure.

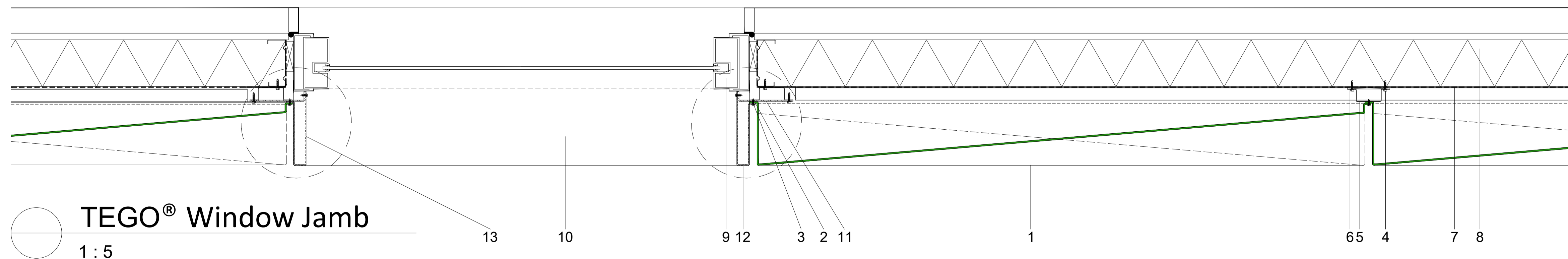

TEGO® Window Jamb
1 : 5

NOTE:

All design related drawings and concepts are property of SOLIDAL®.
Protected under Copyright Law.

PAGE:

12

DWG NAME:

SOLIDAL® TEGO® Oblique
Window Jamb Detail

SCALE:

1 : 1 @ A1

DATE:

20 / MAR / 2023

TEGO®

SOLIDAL®

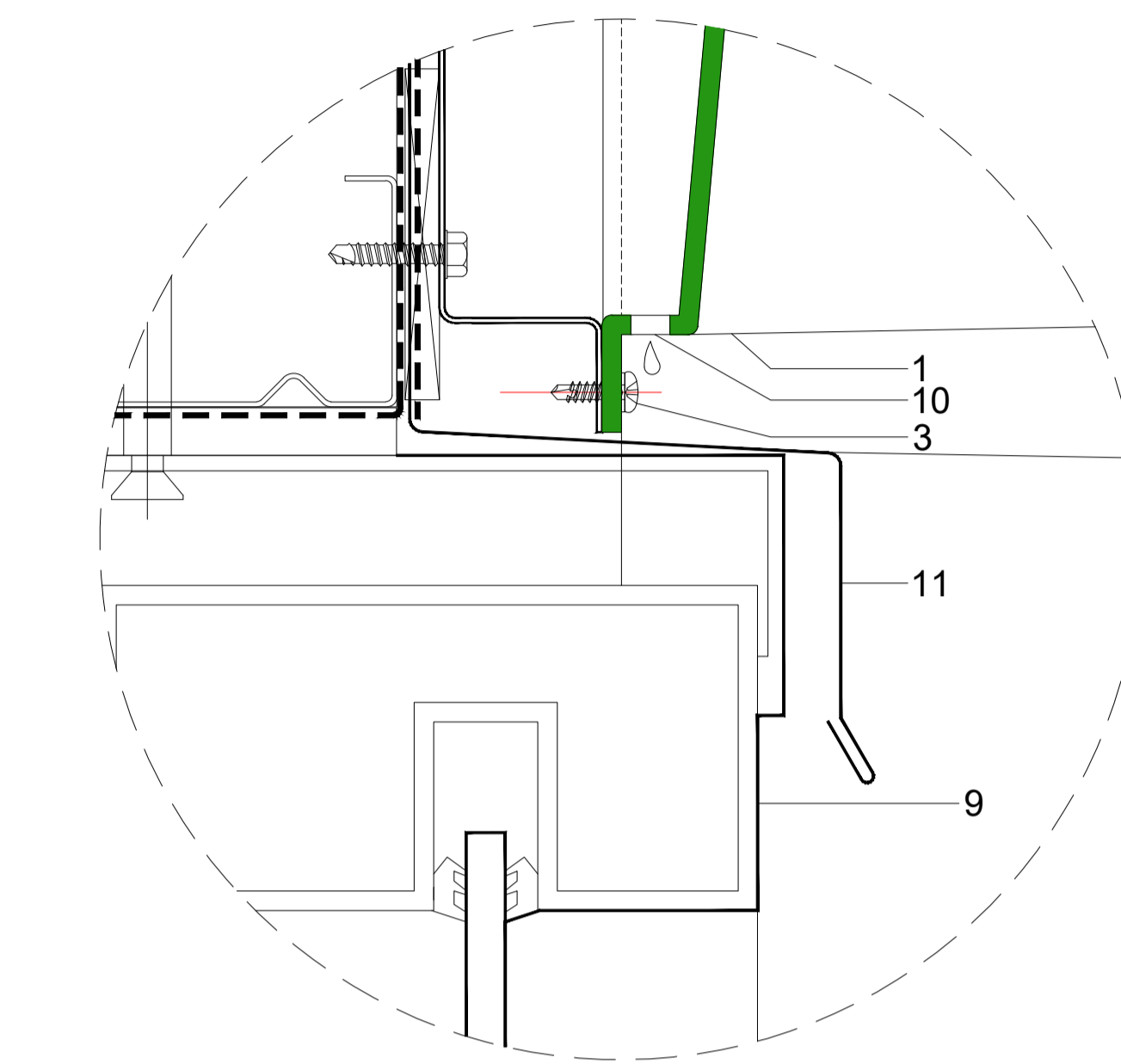
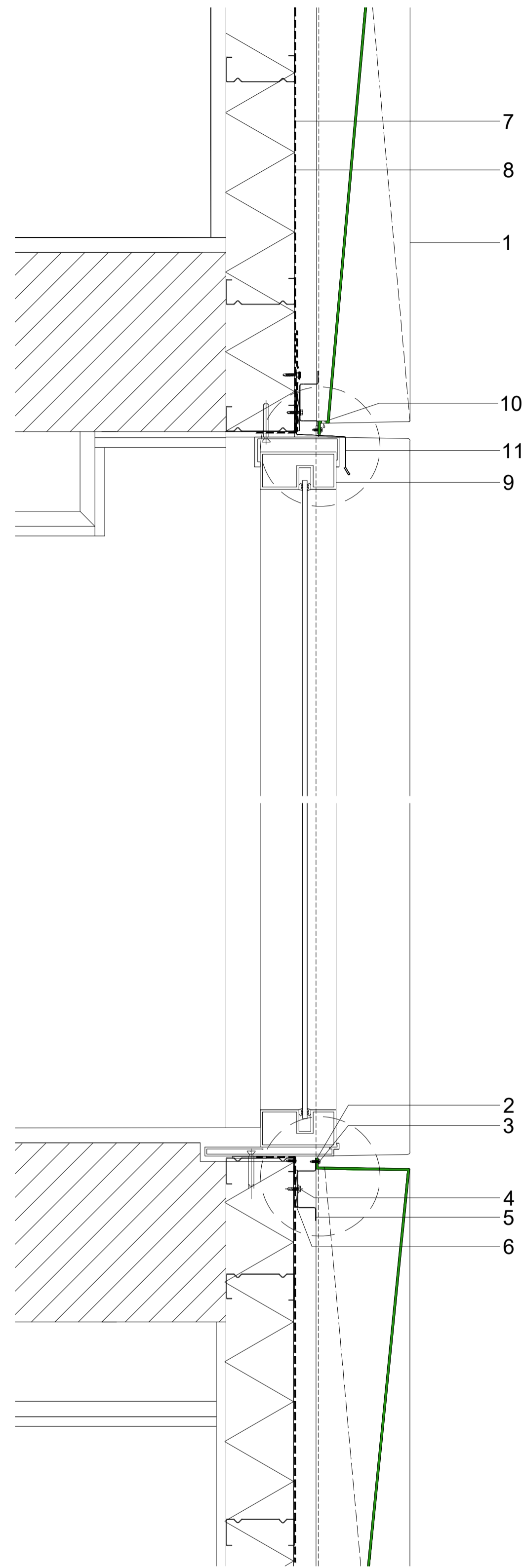

TEGO® Window Head Detail
1:1

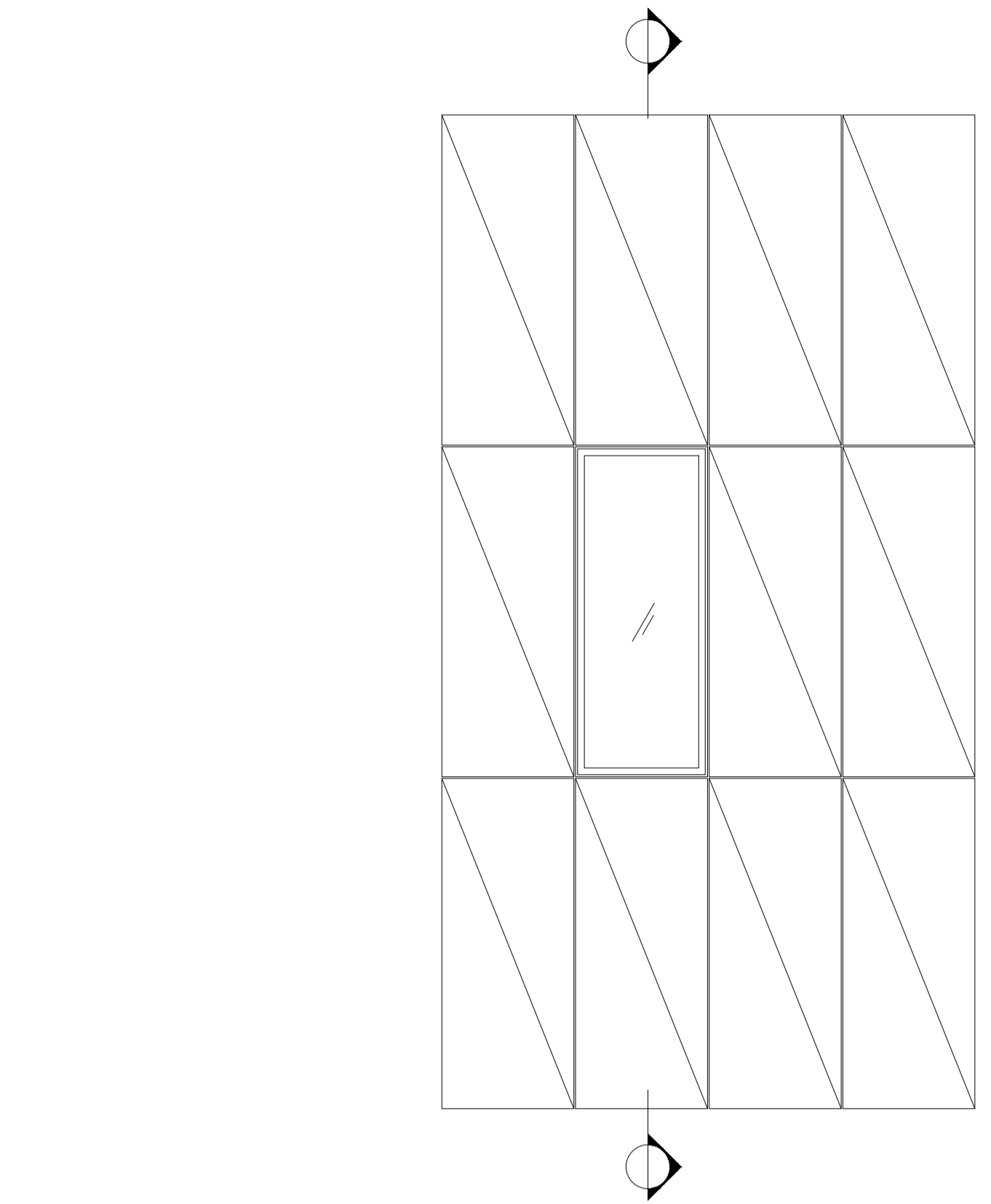

TEGO® Setout Diagram

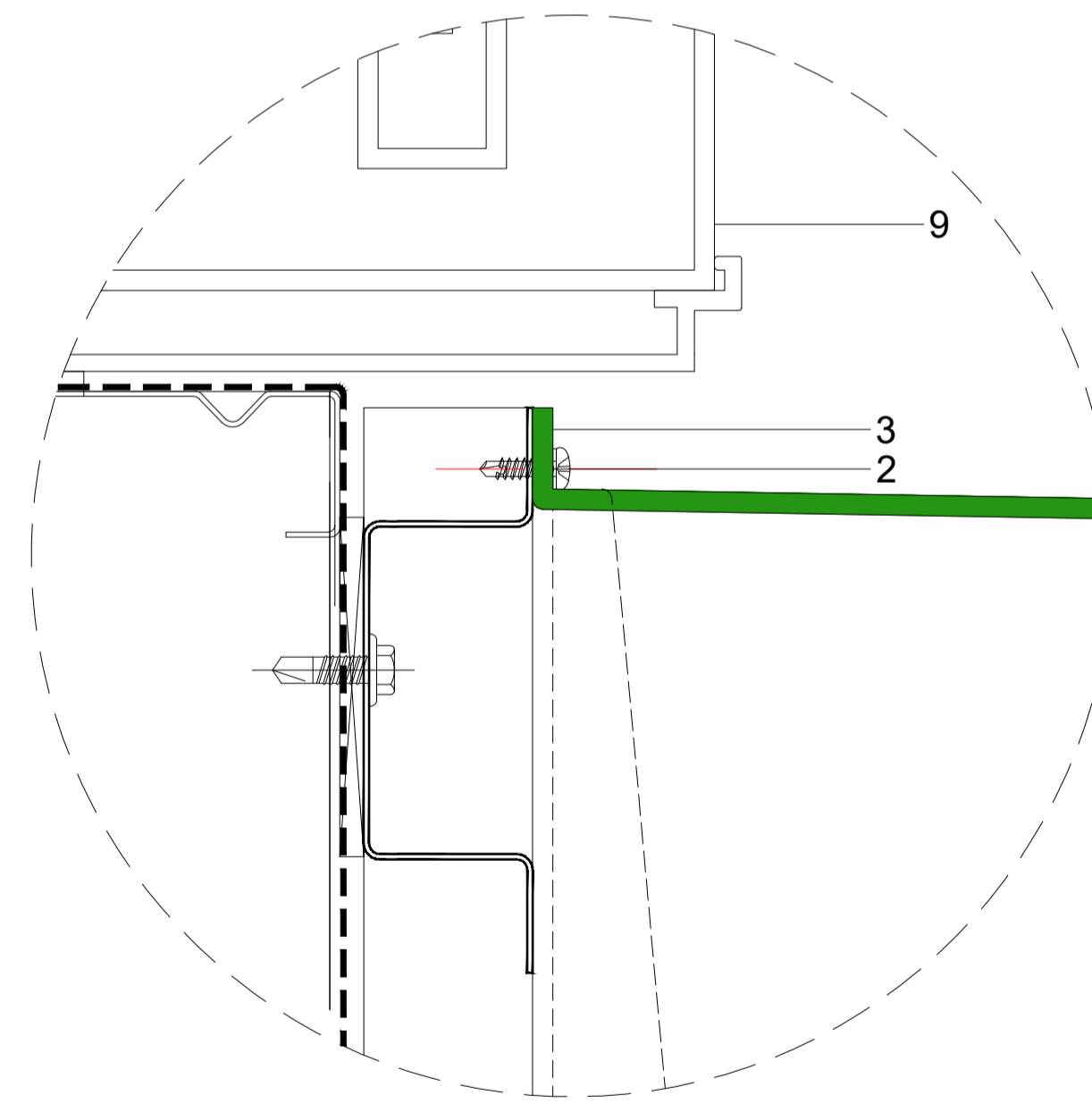

TEGO® Window Sill Detail
1:1

TEGO® Window Details
1:5

SOLIDAL® TEGO®
Window Details - Typical Details

- 1 SOLIDAL® TEGO® Module (T3® Solid Aluminium)
- 2 SOLIDAL® Double-fold
- 3 Tek screw type 1
- 4 Tek screw type 2
- 5 Top hat
- 6 Packing as required
- 7 Weather seal layer
- 8 Building structure
- 9 Window Frame
- 10 Weep Hole
- 11 Metal Flashing

NOTE:

All design related drawings and concepts are property of SOLIDAL®.
Protected under Copyright Law.

PAGE:

13

DWG NAME:

SOLIDAL® TEGO® Oblique
Window Head and Sill Detail

SCALE:

1 : 1 @ A1

DATE:

20 / MAR / 2023

TEGO®

SOLIDAL®

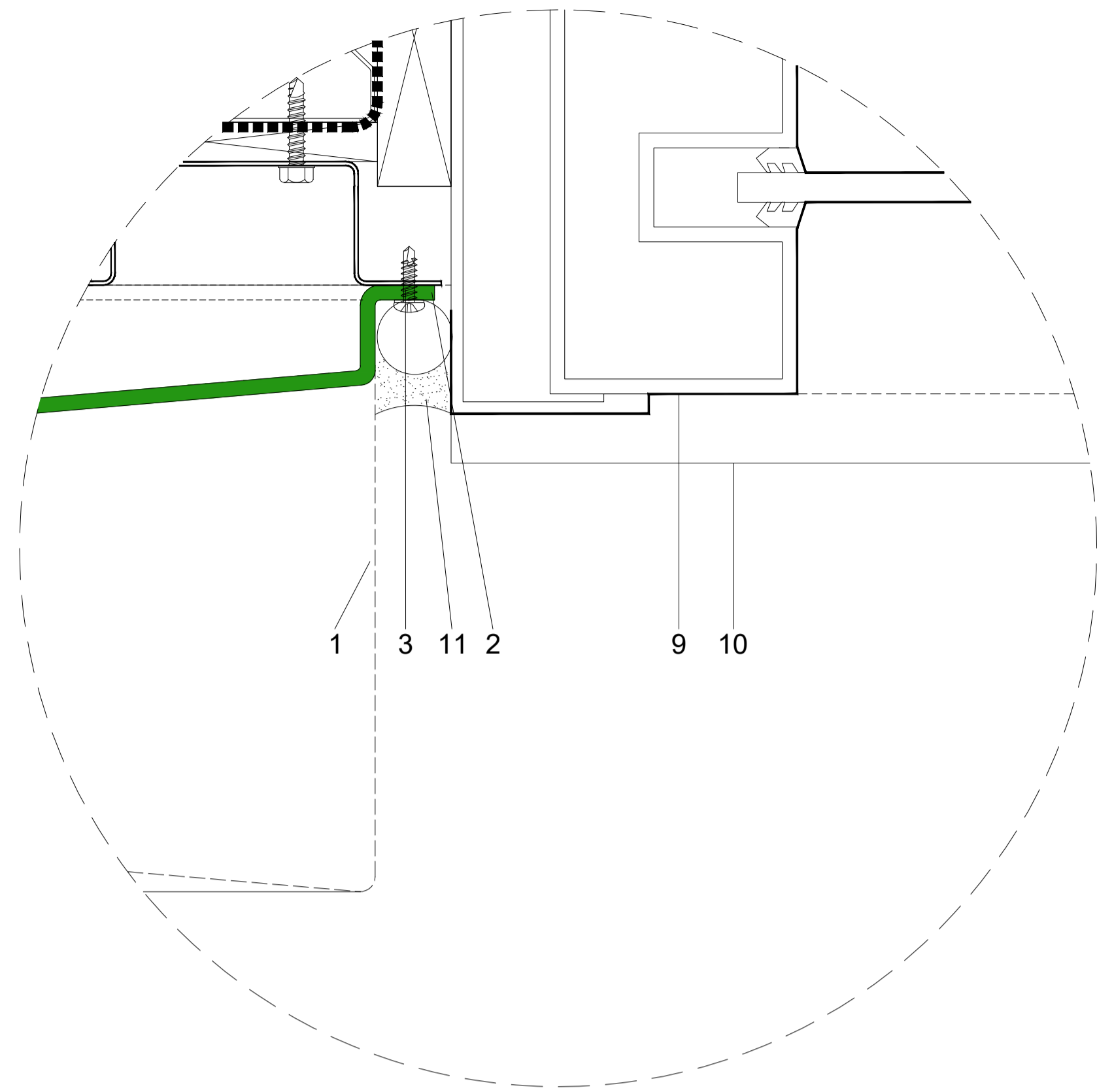

TEGO® Window Jamb
1 : 1

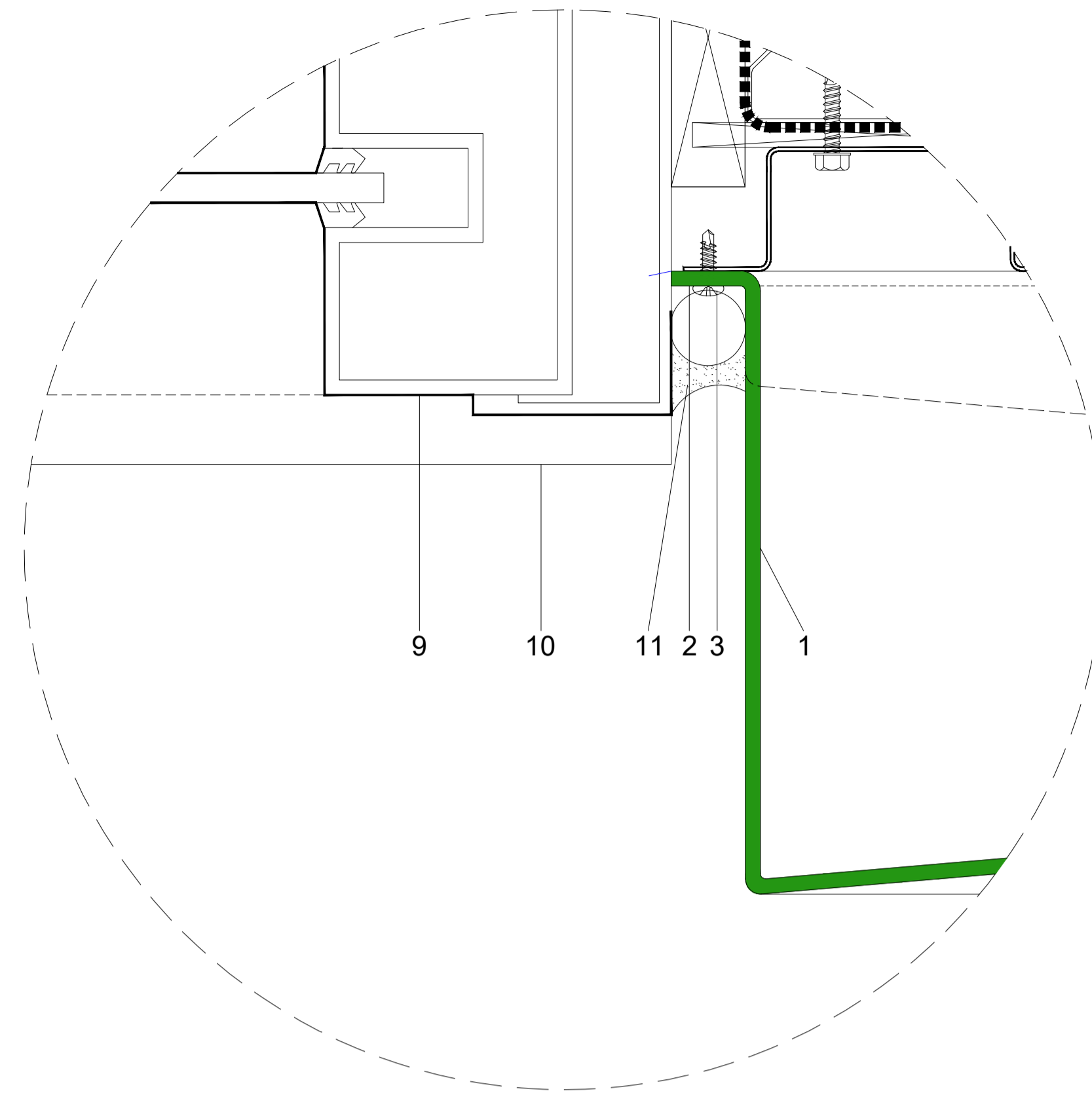

TEGO® Window Jamb
1 : 1

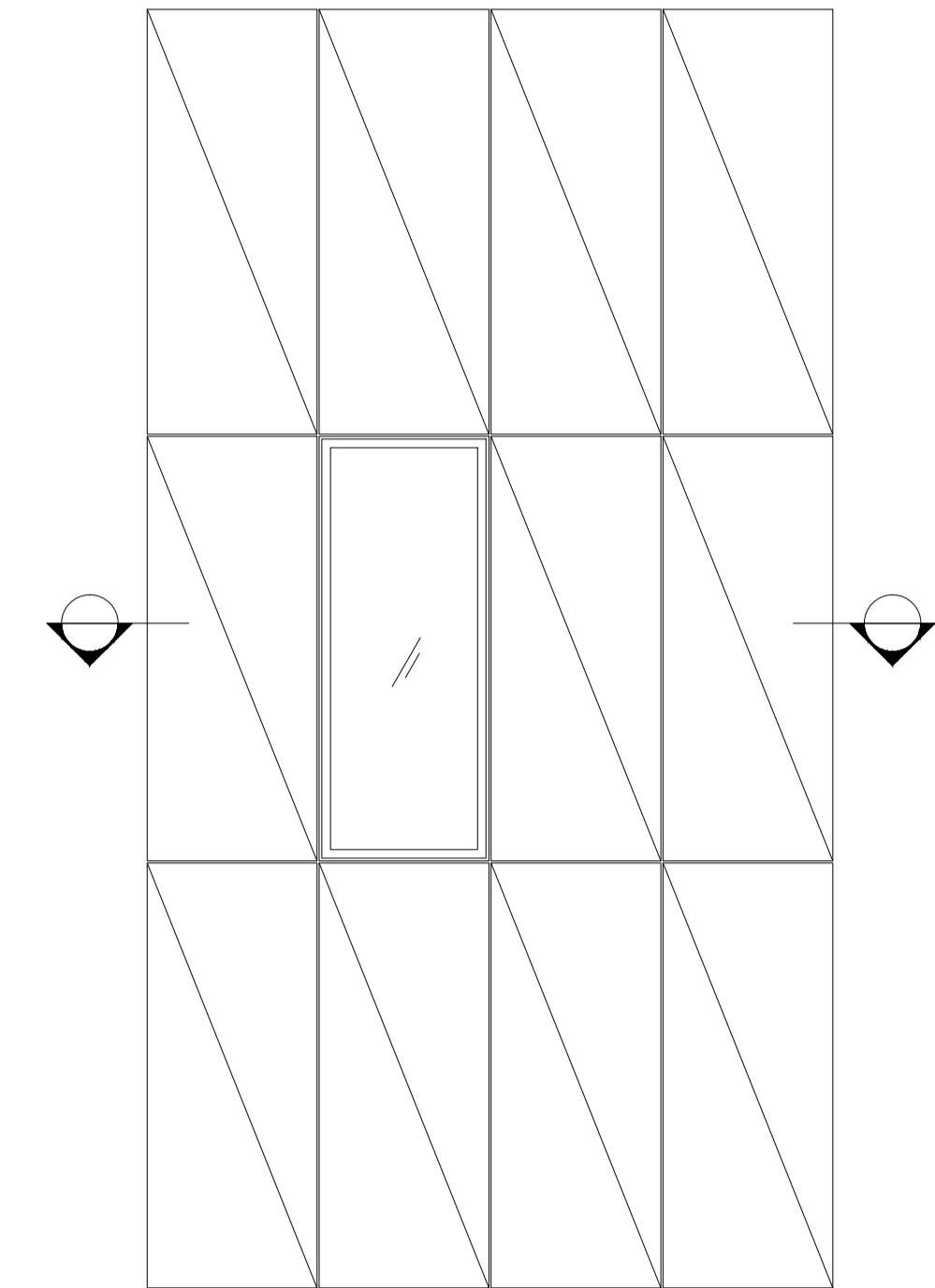

TEGO® Setout Diagram

SOLIDAL® TEGO®
Window Jamb - Typical Details

- 1 SOLIDAL® TEGO® Module (T3® Solid Aluminium)
- 2 SOLIDAL® Double-fold
- 3 Tek screw type 1
- 4 Tek screw type 2
- 5 Top hat
- 6 Packing as required
- 7 Weather seal layer
- 8 Building structure
- 9 Window Frame
- 10 Aluminium Sill Flashing
- 11 Backing Rod & Sealant

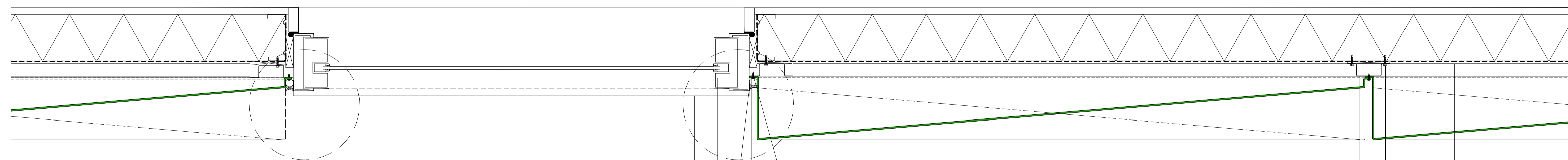

TEGO® Window Jamb
1 : 5

NOTE:

All design related drawings and concepts are property of SOLIDAL®.
Protected under Copyright Law.

PAGE:

14

DWG NAME:

SOLIDAL® TEGO® Oblique
Window Jamb Detail

SCALE:

1 : 1 @ A1

DATE:

20 / MAR / 2023

TEGO®

SOLIDAL®

SOLIDAL®

HEAD OFFICE

10/450 Elizabeth Street,
Surry Hills, Sydney,
NSW, Australia 2010

1300 252 325
info@solidal.com

solidal.com

DISCLAIMER:

All design related drawings and concepts are property of SOLIDAL®.
Protected under Copyright Law.

Any use of SOLIDAL® designs for commercial gain, whether directly or indirectly without proper authorisation, is strictly prohibited. SOLIDAL® reserves the right to seek remuneration for any such unauthorised re-purposing or commercial utilisation of its designs.

SOLIDAL® TEGO® is designed as a rainscreen cladding system.

SOLIDAL® Modules and accessories supplied in full size.

On-site cutting maybe required. Please refer to SOLIDAL® Installation manual.

Separation barrier to be used between dissimilar metals.

For SOLIDAL® Custom Modules, please discuss with SOLIDAL® representative.