



STRAMIT[®]
RAINWATER
PRODUCTS
NSW & ACT

product technical manual



STRAMIT® RAINWATER PRODUCTS NEW SOUTH WALES

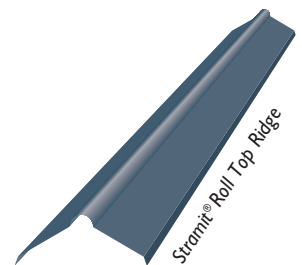
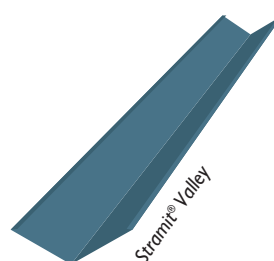
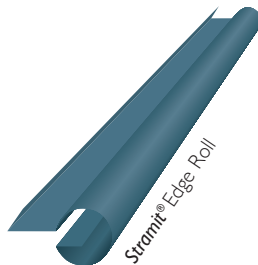
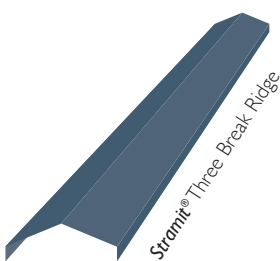
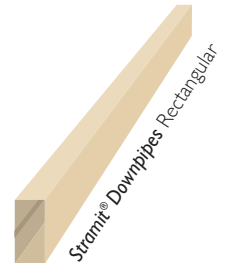
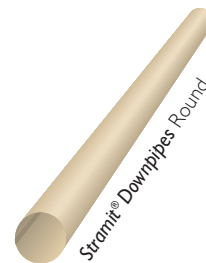
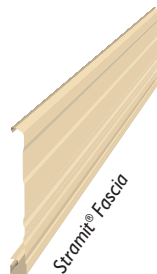
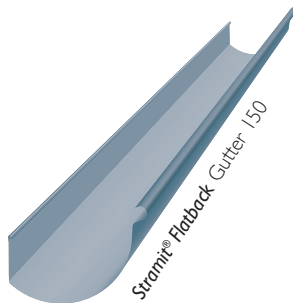
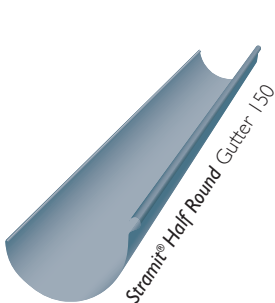
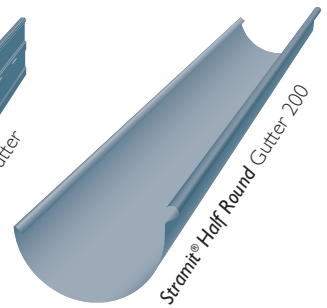
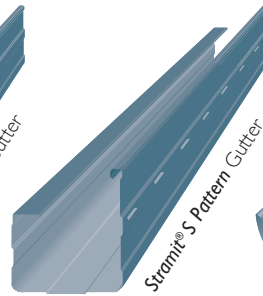
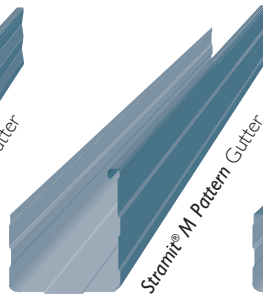
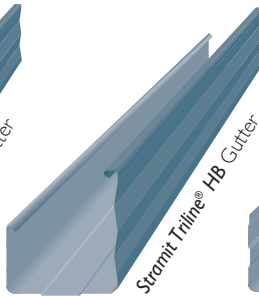
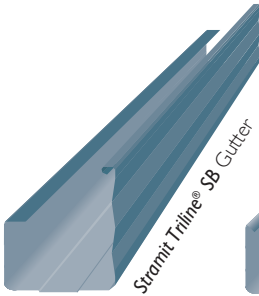
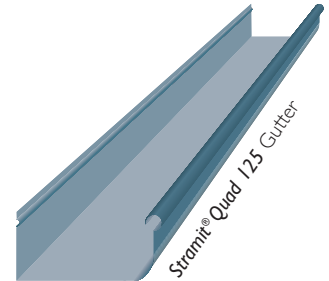
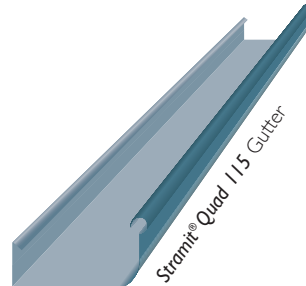
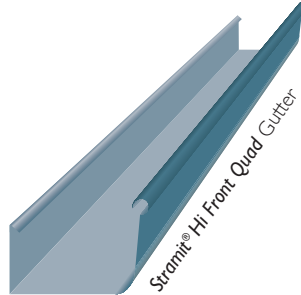
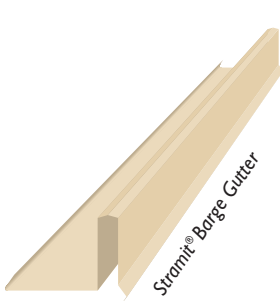

Important Notice and Disclaimer

The information contained within this brochure is intended for general use and information only. Before application in a particular situation, Stramit recommends that you obtain appropriate independent qualified expert advice confirming the suitability of product(s) and information in question for the application proposed. While Stramit accepts its legal obligations, be aware however that to the extent permitted by law, Stramit disclaims all liability (including liability for negligence) for all loss and damage resulting from the direct or indirect use, or reliance on, the information provided in this brochure.

Selection & Specification

General Features

- Extensive range – quality rainwater products.
- Both COLORBOND® steel and Zinc Aluminium or Zinc Aluminium Magnesium coating finishes available.
- A comprehensive range of accessories available.
- Comprehensive design data provided.
- Installation and overflow provision information provided.
- Hi-tensile fascias and gutters.

Applications

Stramit® rollformed rainwater products are designed for installation on residential and light commercial applications, with a comprehensive range of COLORBOND® steel colours to choose from. All products have a wide range of matching accessories.

Stramit® Fascia has a clean yet classic style ideal for all types of home. **Stramit® Quad 115** Gutters are traditional NSW patterns for modest sized applications whilst **Stramit® Hi Front Quad** has a little more drainage capacity and a popular style. **Stramit® M Pattern** Gutter has a larger drainage capacity and is ideal for larger homes and commercial applications and **Stramit® S Pattern** Gutter is designed for shallow metal-roofed applications that have no fascia. The **Stramit Triline®** Gutter was designed for the home improvement market and is suitable for fascia or patio applications.

Stramit® Half-round and Flatback Gutters have large stormwater capacity and are ideal for traditional and contemporary designed buildings.

The extensive range of **Stramit® Downpipes** provides for the full range of domestic, commercial and most industrial applications. Smaller sizes are available in COLORBOND® steel colours. The full complement of **Stramit® Rainwater Products** is completed with valley gutter, ridge capping, edge roll, cappings and flashings.

For larger commercial and industrial applications folded **Stramit® Custom Flashings** are available to suit any box gutter or eave gutter design.

Stramit® Rainwater Products are only intended for use in commercial/industrial/residential rainwater applications. Do not use for any other purpose.

Availability

All of the **Stramit® Rainwater Products** listed in this manual are available in NSW & ACT. However, items available cut-to-length or from stock vary at each Stramit location. Please check with your nearest Stramit office or the Stramit NSW Price & Service Guide for a schedule of availability.

Materials

Stramit® Rainwater Products are manufactured from G550 and G300 Zinc Aluminium or Zinc Aluminium Magnesium coated steel (AZ150/AM125) or galvanized (Z275) in accordance with AS1397, and COLORBOND® steel with a coating conforming to AS2728. Other coatings, grades and materials may be available, subject to enquiry. The mass and steel grade for the primary **Stramit® Rainwater Products** are shown below:

STRAMIT® RAINWATER PRODUCTS – MATERIALS & MASS			
	steel grade	mass (kg/m)	
		Zinc Aluminium	Colorbond®
Stramit® Fascia	G550	0.97	0.98
Stramit® Quad 115 Gutter	G550	0.87	0.88
Stramit® Hi-Front Quad Gutter	G550	0.97	0.98
Stramit® M Pattern Gutter	G550	1.27	1.28
Stramit® S Pattern Gutter	G550	1.33	1.34
Stramit Triline® SB Gutter	G550	1.33	1.34
Stramit Triline® HB Gutter	G550	1.27	1.27
Stramit® Roll Top Ridge	G300	1.66	1.67
Stramit® Three Break Ridge	G300	various	
Stramit® Valley	G550	1.56	1.57
Stramit® Downpipes	G300	various	
Stramit® Barge Gutter	G550	1.07	1.08
Stramit® Half Round 150	G550	1.03	1.04
Stramit® Half Round 200	G550	1.33	1.34
Stramit® Flatback 150	G550	1.03	1.04

Adverse Conditions

Stramit® Rainwater Products coated with zinc-aluminium / zinc-aluminium-magnesium alloy and Colorbond® steel will give excellent durability in almost all locations more than 200m from a marine environment or in some light industrial applications. For installations closer to the coastline, please contact Stramit for advice.

Applications close to industrial or unusually corrosive environments will need to be individually assessed for durability. Contact your nearest Stramit office for advice.

Colours

Most **Stramit®** products are available in the full range of COLORBOND® steel colours. In addition other colours, including gloss finish are stocked at some locations. Please check with your nearest Stramit Building Products office or distributor for availability.

Material Compatibility

Drainage from copper or lead products (including roof flashings) should not be allowed to discharge on to zinc aluminium, zinc aluminium magnesium coated steel or COLORBOND® steel components. Similarly, lead or copper components should not be installed in contact with zinc aluminium or zinc aluminium magnesium coated steel. Each of these combinations will lead to premature corrosion.

Drainage from copper, COLORBOND® steel and zinc aluminium, zinc aluminium magnesium coated steel, translucent (or other inert material) should not be allowed to discharge onto, or into, galvanised products.

Fascia/Gutter Compatibility

Only **Stramit®** Gutters may be used with **Stramit® Fascia**. Similarly only authentic Stramit accessories are suitable for connecting **Stramit®** Gutters to **Stramit® Fascia**.

Testing

Stramit Building Products has in-house, purpose built testing equipment used to design, develop and improve products for the Australian market. In addition many **Stramit®** products are tested or witnessed by independent organisations. These include:

- University of Technology, Sydney
- Cyclone Structural Testing Station (James Cook University)

- The University of Sydney
- CSIRO

The ongoing research and development activity ensure that Stramit remains at the forefront of innovation, design and consumer information.

Architectural Specification

A similar specification for each product can be found on the Stramit web site and can easily be downloaded onto your documentation.

The [product type – e.g. gutter] shall be Stramit [product name – e.g. M Pattern] or agreed exact equivalent in size and performance. Material shall be protected steel sheet to Australian Standard AS1397 with a minimum yield stress of 550MPa and an AM100/AZ150 coating with a (nominate colour) oven baked paint film or a plain AM125/AZ150 coating. All accessories are to be fully compatible as recommended by the manufacturer. The product and its accessories shall be installed strictly in accordance with the manufacturer's recommendations and all applicable regulations. Flashings and all adjacent products shall be supplied in compatible materials as specified. All work shall be fixed in a workman like manner, leaving the job clean and weather tight. All debris (screws, rivets, cuttings and filings, etc) shall be cleaned off daily. Repair all minor blemishes with touch up paint supplied by the manufacturer.

Standards Conformance

All **Stramit® Rainwater Products** are conformant with, or equivalent to AS2179.

Gutter Overflow

Gutter overflow needs to be considered when designing and installing gutter systems. The overflow devices should have adequate capacity and the roof drainage system must be in accordance with AS 3500.3. Detailed information is provided in this document on pages 6 and 7.

Design

GENERAL

Performance

Stramit® Rainwater Products have been designed and/or tested to all appropriate loadings and design action effects. These include wind, atmospheric corrosion, rainwater flow, rainwater mass, foot traffic loads, dead loads and ladder loads. The performance information for each product indicates those action effects accounted for in each case.

Rainfall Intensity

Values of rainfall intensity in the table are for 20 and 100 year ARI, 5 minute durations and have been derived from NCC 2016 and Bureau of Meteorology data. It should however be emphasised that the extent and longevity of records in Australia are limited and any such data therefore carries with it a degree of uncertainty. The 20 year ARI values should only be used for external eave gutters. For internal/box gutters and overflow design, use 100 year ARI values.

RAINFALL INTENSITIES (mm/hr)		
	20 year	100 year
Australian Capital Territory		
Canberra	143	193
New South Wales		
Albury	139	180
Armidale	179	238
Batemans Bay	192	268
Bathurst	125	164
Bowral	161	220
Broken Hill	143	219
Coffs Harbour	277	382
Cowra	140	190
Dubbo	167	222
Forbes	151	205
Gosford	218	313
Goulburn	121	156
Kempsey	216	287
Kiama	226	319
Lismore	208	270
Lithgow	149	196
Maitland	191	266
Mittagong	163	222
Newcastle	226	316
Nowra	179	247
Orange	142	186
Parramatta	163	209
Penrith	180	244
Port Macquarie	233	313
Riverstone	176	234
Sydney	200	262
Tweed Heads	252	330
Wagga Wagga	154	208
Wollongong	217	308
Wyong	221	320

Specific data for any location can be obtained from the Australian Bureau of Meteorology.

Snow

It is common practice not to use gutters in snow prone areas but to take care of roof run-off at ground level. Information on designing in snow areas can be found in Standards Australia Handbook HB 106 "Guidelines for the design of structures in snow areas".

In snow prone areas **Stramit® Fascia** may only be used with a tilt batten designed to take the additional roof loading.

Hail

Experience has shown that **Stramit®** Steel Gutters are able to resist impact from significantly sized hail without damage. However, in hail prone areas consideration should be given to ensuring that gutter fronts are well below roof level. This should avoid the damming effect of hail which, if it builds up onto the roof, can lead to overloading and failure of the gutter.

Leaves

Leaves in gutters can be a problem. They come in many shapes and sizes and roof debris may also include branches, twigs and both organic and inorganic particles. Many systems have been and are used to try to solve this problem. The optimum solution will vary with each situation and may be influenced by a number of factors that include the nature and proximity of vegetation, the level of maintenance and the primary motivation (eg water collection, maintenance reduction, gutter system durability, bushfire hazard reduction etc)

One method is to use adequately sized gutters set well below the roof edge with a good fall and large down-pipes with well angled offsets to avoid corner blockages, clear frequently and remove overhanging vegetation. An often-used method is an additional mesh guard or perforated gutter covering. Those of a very fine mesh will keep most debris from the gutters but can be prone to dirt and algal build up leading to mesh blockage. This does keep leaves from the gutter and down-pipe, but ultimately it may not allow water to pass into the gutter. Any water trapped within the gutter may not dry out which could compromise durability.

Larger mesh guards stop large leaves and branches from entering the gutter but it may be possible for twigs and branches to catch in the mesh ultimately creating a dam causing water to flow back into the building eaves.

It is also important, if a cover or leaf guard is used, that it is material-compatible with the gutter and that both the gutter and the guard are cleared regularly.

DESIGN FACTORS

In the design and detailing of a roof drainage system, consideration must be given to a range of factors such as rainfall intensity, roof catchment area, gutter size/capacity, gutter fall, gutter outlets (sumps, rainwater heads, nozzles), downpipes (size, quantity and placement), overflow consideration, material selection, jointing, etc.

Building Code Compliance

Under the Environmental Planning and Assessment Act 1979 and its regulations, all building work must be carried out in accordance with the Building Code of Australia (BCA), now part of the National Construction Code (NCC). In addition to referring to Australian Standards AS/NZS 3500.3, and AS/NZS 3500.5, the BCA also contains requirements for the disposal of surface water in Volume One, Performance Requirements FP1.2 and FP 1.3, and in Volume Two, Part 3.5.2, namely, Performance Requirement P2.2.1 and Clauses 3.5.2.1. to 3.5.2.5.

The most common means of satisfying these requirements for roof drainage (i.e. guttering) installations is by complying with the National Plumbing and Drainage Code AS/NZS 3500.3.

Furthermore, in each state and territory it is necessary to satisfy the relevant regulation. The NSW Code of Practice for Plumbing and Drainage adopts AS/NZS 3500.3 and associated amendments.

High Front Gutters

High front gutters are commonly used in residential roof drainage systems to conceal the lower edge of roof cladding or tiles. These gutters form part of the roof drainage system, which is required to comply with the National Construction Code. Details of the design process for roof drainage systems, which includes selecting overflow measures, are given in The National Plumbing and Drainage Code AS/NZS 3500.3. Information on overflow measures is also given in the National Construction Code.

Overflow Provision

The Building Code of Australia requires that where high-fronted gutters are installed provision must be made to avoid any overflow back into the roof or building structure by incorporating overflow measures or the like. Overflow design must be based on the 100 year ARI 5 minute duration rainfall intensity.

Methods of providing for overflow in the design and installation of roof drainage systems with high front gutters may include:

- Slotted gutter front to allow for water overflow through the slots visible on the front face of the gutter.
- Gap between the fascia and the gutter back, either by inserting a packer between the back of the gutter and the fascia or by employing proprietary systems and trade solutions.
- Specific overflow measures, such as:
 - Inverted downpipe drop/pop nozzle at high points in the gutter but set at a level below the fascia top.
 - Stop ends cut down to a lower level to act as a weir. Stop end weirs could be hidden at the high point of the gutter and designed as part of an expansion joint.
 - Rainwater heads with overflow weir
 - Holes, slot, or weir at downpipes

Examples of continuous and non-continuous overflow measures are illustrated on page 7. Slotted gutters may also provide an adequate overflow measure in some applications. In high rainfall intensity regions a combination of overflow methods may be required.

Alternative Overflow Measures

Overflow may also be addressed through alternative building design methods, such as:

- Unlined eaves, where appropriate to the house design, to eliminate the issue.
- Gutter installed so that the gutter front is 10mm below the top of the fascia.
- Back flashing, where gutter support brackets allow for installation of back flashing (e.g., external brackets).

The detailing and sizing of the selected overflow method/s is normally completed by the designer/installer, but must be adequate for the situation and must meet the relevant performance requirements of the NCC and Australian Standards.

Maintenance Considerations

In the longer term, the ability of a roof drainage system to handle overflow will also depend on the regular cleaning of the system. For example, the removal of plant or animal matter (leaves, fungal growth, droppings, nests, etc.) and debris from gutters, leaf-guard systems and the gutter overflow devices to ensure free drainage of water.

Adequate maintenance is a requirement of rainwater goods warranties.

Installer Responsibility

While there may be variations between states, contractors who install guttering systems are generally required to hold an appropriate licence. The work is required to comply with the appropriate codes and standards. Statutory warranties normally apply and consumers have a right to lodge a complaint with the appropriate authority.

During the installation of the roof drainage system, particular attention should be given to the following:

- The use of compatible materials for drainage system components, leaf-guard system components and fasteners/sealants to connect and seal the components.
- The position of the gutter in relation to the fascia.
- Installation of the specified gutter and downpipes, and ensuring that downpipes are installed in the correct locations and numbers.
- Gutter fall, ensuring sufficient fall in the direction of the downpipes.
- Overflow must be allowed for and specific components installed where required.
- All debris and loose waste materials (swarf, fasteners, etc.) must be cleaned off at the end of each day and at the completion of the installation, to prevent blockages of the drainage system or deterioration of the individual components. Any protective films should also be removed as part of the installation process.

Continuous overflow measures

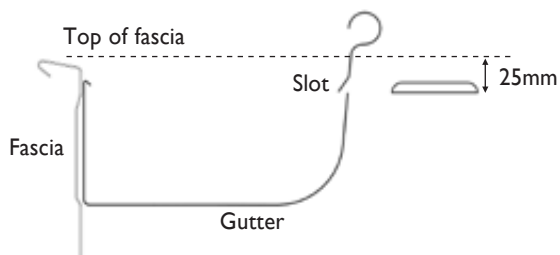

Slotted gutter with slot area 1200mm²/m
– overflow capacity 0.5L/s/m

720mm²/m – overflow capacity 0.3L/s/m

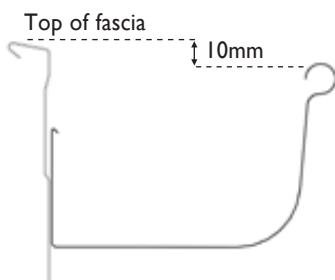

Front of gutter 10mm below top of fascia
– overflow capacity 1.5 L/s/m

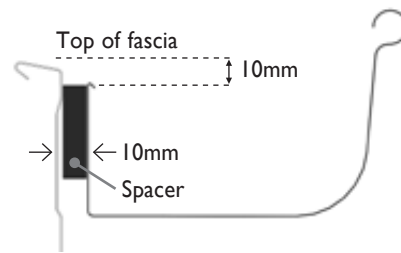

10mm gap between gutter and fascia
– overflow capacity 1.5 L/s/m

Specific overflow measures

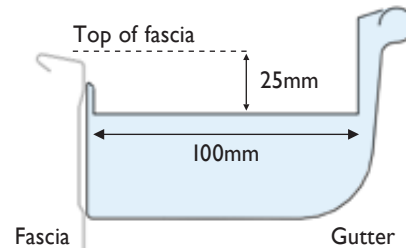

Stop ends finished below top of fascia and rear of gutter to form a weir – overflow capacity 0.5L/s

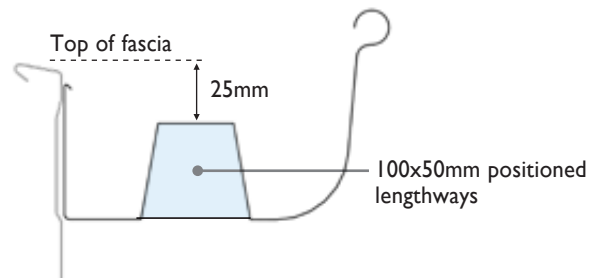

Inverted nozzle at high ends of gutter finished below back of gutter – overflow capacity 1.2L/s

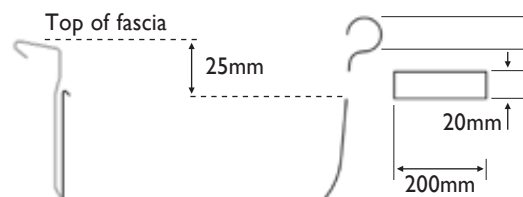

Front face weir – overflow capacity 1.0L/s

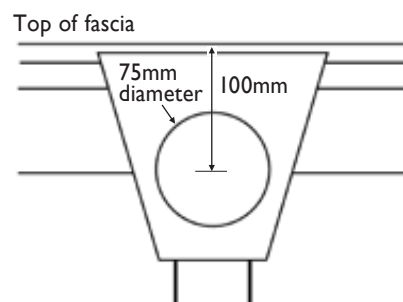

Rainhead – overflow capacity 3.5L/s

STRAMIT® FASCIA

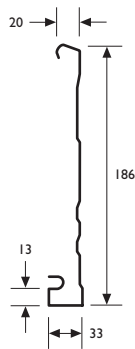

Spans

The spanning capability of **Stramit® Fascia** shown has been determined by testing (in accordance with AS4040.1) for a combination of roof tile and foot traffic loads. The maximum spacing of **Stramit® Fascia** rafter brackets is:

– Where a separate tilt/roof batten is fitted adjacent to the fascia:

- internal spans 1500
- end spans 1200 maximum (200 minimum)

Note that for a jack rafter to be considered as a support position it must be adequately connected to the hip rafter.

– Where the fascia is used as the tilt batten:

- internal spans 1200
- end spans 900

Pressures

The wind resistance of **Stramit® Fascia** has then been determined at these spans by testing in accordance with AS4040.2 – and for each of the spans is suitable for use in areas of up to: 0.92 kPa SERVICEABILITY LIMIT-STATE, 2.25 kPa STRENGTH LIMIT-STATE. These pressures are equivalent to: N3 (Region A – rural, Region B – exposed suburban).

STRAMIT® GUTTERS

STRAMIT® GUTTERS – CROSS SECTIONAL AREA (mm²)

Gutter Style	Slotted	Unslotted
Stramit® Quad 115 Gutter		4700
Stramit® Hi-Front Quad Gutter	5200	5300
Stramit® Quad 125 Gutter		6200
Stramit Triline® HB and SB Gutter	7700	7700
Stramit® M Pattern Gutter	7900	9100
Stramit® S Pattern Gutter	7900	9100
Stramit® Half Round Gutter 150	7700	7700
Stramit® Flatback Gutter 150	7800	7800
Stramit® Half Round Gutter 200		13500

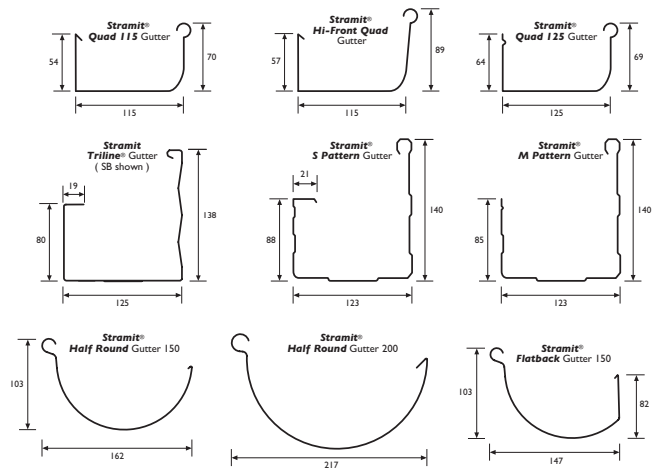

Spans

Stramit® Gutters require the correct proprietary **Stramit®** brackets (or snap clip/stiffener bracket combination) for support at spacing no greater than those shown in the following table.

STRAMIT® GUTTERS – MAXIMUM SUPPORT SPACINGS (mm)

Stramit® Quad 115 Gutter	1200
Stramit® Hi-Front Quad Gutter	1200
Stramit® M Pattern Gutter	1200
Stramit® S Pattern Gutter	1200
Stramit Triline® HB and SB Gutter	1200
Stramit® Half Round Gutter 150	900
Stramit® Half Round Gutter 200	900
Stramit® Flatback Gutter 150	900

Thermal Expansion

Gutter runs in excess of 20m require the provision of an expansion joint.

Fall

Stramit recommends that an absolute minimum fall of 1 in 500 be used for all gutters, this being a design requirement for the gutter and downpipe selection table [on the facing page]. Good fall reduces the risk of leaf and debris deposition that could otherwise effect durability.

Gutter Capacity

In theory any size of gutter can be used to drain any roof catchment. What controls design is the number of downpipes needed to perform within the capacity of each gutter. In practice the larger the gutter the less the number of downpipes required, as indicated in the table [opposite].

Normally catchment calculations must take into account the increased area due to roof slope. The required downpipe table incorporated into this manual takes account of roof slopes up to 23°. Therefore the roof area for use with this table requires only the simple calculation of plan area.

Gutter Style											Max area per downpipe (m ²)	STRAMIT® GUTTERS & DOWNPIPES – NUMBER OF DOWNPIPES REQUIRED FOR TYPICAL ROOF INSTALLATION											
Stramit® Quad 115	Stramit® Hi-Front Quad	Stramit® Quad 125	Stramit® Triline® HB & SB	Stramit® M/S-Pattern	Stramit® Half Round 150	Stramit® Flatback 150	Stramit® Half Round 200	Slotted ?				roof plan area (m ²) – for roofs up to 23°											
N	Y	N	N	Y/N	Y	N	Y/N	Y/N	N														
Location rainfall intensity (mm/hr)												100	120	140	160	180	200	220	240	260	280	300	
											160	100	2	2	2	2	3	3	3	3	4	4	4
											170	94	2	2	2	3	3	3	3	4	4	4	4
											180	89	2	2	2	3	3	3	3	4	4	4	5
											190	84	2	2	3	3	3	3	4	4	4	5	5
											200	80	2	2	3	3	3	4	4	4	4	5	5
									130		220	73	2	2	3	3	3	4	4	4	5	5	5
									140		230	70	2	3	3	3	4	4	4	5	5	5	6
											240	67	2	3	3	3	4	4	4	5	5	6	6
									150		65	2	3	3	3	4	4	5	5	5	6	6	6
									130		250	63	2	3	3	4	4	4	5	5	5	6	6
									160	130	260	61	2	3	3	4	4	4	5	5	6	6	6
									140		270	58	3	3	3	4	4	5	5	5	6	6	7
									140		280	57	3	3	3	4	4	5	5	6	6	6	7
									150		290	55	3	3	4	4	4	5	5	6	6	7	7
									180		54	3	3	4	4	5	5	5	6	6	7	7	7
									150		53	3	3	4	4	5	5	6	6	6	7	7	7
									160	200	49	3	3	4	4	5	5	6	6	7	7	8	8
									170	170	45	3	4	4	5	5	6	6	7	7	8	8	8
									180		44	3	4	4	5	5	6	6	7	7	8	8	9
									180		44	3	4	4	5	5	6	7	7	8	8	9	9
									140		42	3	4	4	5	6	6	7	7	8	8	9	9
									190		42	3	4	5	5	6	6	7	7	8	9	9	9
									200	240	41	3	4	5	5	6	6	7	8	8	9	9	9
									200		40	4	4	5	5	6	7	7	8	8	9	10	10
									210	250	39	4	4	5	5	6	7	7	8	9	9	10	10
									130		38	4	4	5	6	6	7	7	8	9	9	10	10
									160	210	38	4	4	5	6	6	7	8	8	9	9	10	10
									130		37	4	4	5	6	6	7	8	8	9	10	10	10
									140	170	35	4	5	5	6	7	7	8	9	9	10	11	11
									140		35	4	5	5	6	7	7	8	9	10	10	11	11
											34	4	5	5	6	7	8	8	9	10	10	11	11
									180		33	4	5	6	6	7	8	8	9	10	11	11	11
									150		33	4	5	6	6	7	8	9	9	10	11	11	11
									130	150	32	4	5	6	6	7	8	9	9	10	11	12	12
											32	4	5	6	7	7	8	9	10	10	11	12	12
									160		31	4	5	6	7	8	8	9	10	11	11	12	12
									140	160	30	4	5	6	7	8	8	9	10	11	12	12	12
											30	5	5	6	7	8	9	9	10	11	12	13	13
											29	5	5	6	7	8	9	10	10	11	12	13	13
											29	5	6	6	7	8	9	10	11	11	12	13	13
									150	170	28	5	6	7	7	8	9	10	11	12	13	14	14
											27	5	6	7	8	8	9	10	11	12	13	14	14
									180		27	5	6	7	8	9	9	10	11	12	13	14	14
									180		27	5	6	7	8	9	10	10	11	12	13	14	14
											26	5	6	7	8	9	10	11	12	12	13	14	14
											26	5	6	7	8	9	10	11	12	13	13	14	14
									170	200	24	5	6	7	8	9	10	11	12	13	14	15	15
									180	210	23	6	7	8	9	10	11	12	13	14	15	16	16
											23	6	7	8	9	10	11	12	13	14	15	17	17
											23	6	7	8	9	10	11	12	13	14	16	17	17
											22	6	7	8	9	10	11	13	14	15	16	17	17
											22	6	7	8	9	11	12	13	14	15	16	17	17
									200		21	6	7	8	10	11	12	13	14	15	16	17	18
											21	6	7	9	10	11	12	13	14	15	17	18	18
											21	6	8	9	10	11	12	13	15	16	17	18	18
									210	240	20	6	8	9	10	11	12	14	15	16	17	18	19
											20	7	8	9	10	11	13	14	15	16	18	19	19
									220	250	19	7	8	9	10	12	13	14	15	17	18	19	19
									230		19	7	8	10	11	12	14	15	16	17	19	20	20
									240		18	7	9	10	11	13	14	15	17	18	20	21	21
									250		17	8	9	10	12	13	15	16	17	19	20	22	22

Intensities for Sydney

Note: Minimum gutter gradient 1:500 or steeper

The selection of the number of downpipes is carried out in accordance with AS3500.3 (Stormwater drainage)

However, the larger the gutter the larger the downpipe

required. The minimum size of downpipe associated with each **Stramit®** Gutter is given in the **Stramit® Downpipes** section that follows.

Overflow Measures

Slotted **Stramit®** gutters give some overflow provision, when used with the **Stramit® Snap Clip**. A higher overflow volume can be catered for by providing the **Stramit® Gutter Spacer** or the **Stramit BAT® Clip**. The table below gives the maximum sloped roof run length which can be used for the overflow through the slots, and back of gutter. These values are based on independent testing. Where the **Stramit® Gutter Spacer** or **BAT® Clip** is used, they need to be installed as recommended in the installation leaflets provided with the product.

Roof Run Length

When finding the maximum sloped roof run length, it is important to consider the additional length of roof which contributes to the flow in any one position, if there is a roof penetration or spreader. In these positions, the effective roof run length would be longer than the distance from the ridge to the eaves. A simplified method of finding this length is shown in the illustration. In this case, the maximum roof run length is 14m for a 10m length of roof due to the penetration 4m down from the ridge.

If the catchment area is known, the roof run length can be found by dividing the area by the length of gutter it feeds into.

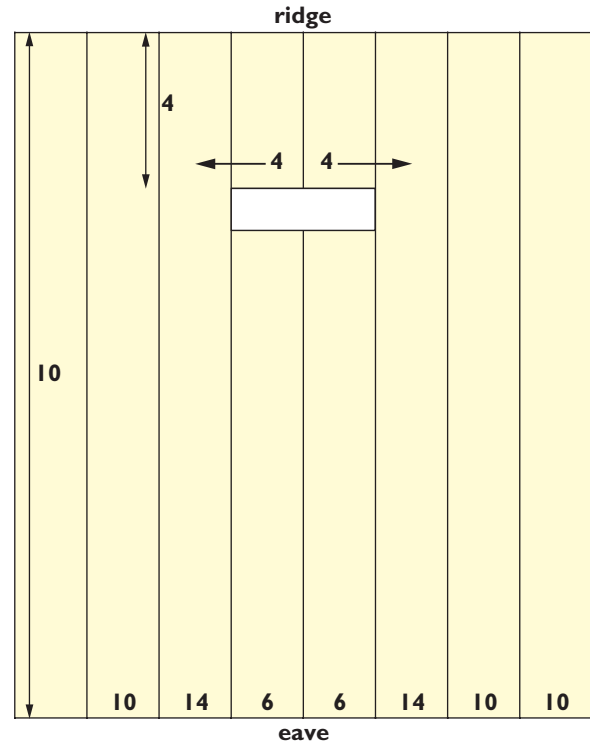

DRAFT TABLE – SUBJECT TO CHANGE

OVERFLOW MEASURES - NEW SOUTH WALES AND AUSTRALIAN CAPITAL TERRITORY

Location	Rainfall Intensity (mm/hr)	Maximum roof length feeding into gutter (m)																									
		4	4.5	5	5.5	6	6.5	7	7.5	8	8.5	9	9.5	10	10.5	11	11.5	12	12.5	13	13.5	14	14.5	15	15.5	16	
ACT																											
Canberra	193	0.21	0.24	0.27	0.29	0.32	0.35	0.38	0.40	0.43	0.46	0.48	0.51	0.54	0.56	0.59	0.62	0.64	0.67	0.70	0.72	0.75	0.78	0.80	0.83	0.86	
NSW																											
Goulburn	156	0.17	0.20	0.22	0.24	0.26	0.28	0.30	0.33	0.35	0.37	0.39	0.41	0.43	0.46	0.48	0.50	0.52	0.54	0.56	0.59	0.61	0.63	0.65	0.67	0.69	
Bathurst	164	0.18	0.21	0.23	0.25	0.27	0.30	0.32	0.34	0.36	0.39	0.41	0.43	0.46	0.48	0.50	0.52	0.55	0.57	0.59	0.62	0.64	0.66	0.68	0.71	0.73	
Albury	180	0.20	0.23	0.25	0.28	0.30	0.33	0.35	0.38	0.40	0.43	0.45	0.48	0.50	0.53	0.55	0.58	0.60	0.63	0.65	0.68	0.70	0.73	0.75	0.78	0.80	
Orange	186	0.21	0.23	0.26	0.28	0.31	0.34	0.36	0.39	0.41	0.44	0.47	0.49	0.52	0.54	0.57	0.59	0.62	0.65	0.67	0.70	0.72	0.75	0.78	0.80	0.83	
Cowra	190	0.21	0.24	0.26	0.29	0.32	0.34	0.37	0.40	0.42	0.45	0.48	0.50	0.53	0.55	0.58	0.61	0.63	0.66	0.69	0.71	0.74	0.77	0.79	0.82	0.84	
Lithgow	196	0.22	0.25	0.27	0.30	0.33	0.35	0.38	0.41	0.44	0.46	0.49	0.52	0.54	0.57	0.60	0.63	0.65	0.68	0.71	0.74	0.76	0.79	0.82	0.84	0.87	
Forbes	205	0.23	0.26	0.28	0.31	0.34	0.37	0.40	0.43	0.46	0.48	0.51	0.54	0.57	0.60	0.63	0.65	0.68	0.71	0.74	0.77	0.80	0.83	0.85	0.88	0.91	
Wagga Wagga	208	0.23	0.26	0.29	0.32	0.35	0.38	0.40	0.43	0.46	0.49	0.52	0.55	0.58	0.61	0.64	0.66	0.69	0.72	0.75	0.78	0.81	0.84	0.87	0.90	0.92	
Parramatta	209	0.23	0.26	0.29	0.32	0.35	0.38	0.41	0.44	0.46	0.49	0.52	0.55	0.58	0.61	0.64	0.67	0.70	0.73	0.75	0.78	0.81	0.84	0.87	0.90	0.93	
Broken Hill	218	0.24	0.27	0.30	0.33	0.36	0.39	0.42	0.45	0.48	0.51	0.55	0.58	0.61	0.64	0.67	0.70	0.73	0.76	0.79	0.82	0.85	0.88	0.91	0.94	0.97	
Bowral	220	0.24	0.28	0.31	0.34	0.37	0.40	0.43	0.46	0.49	0.52	0.55	0.58	0.61	0.64	0.67	0.70	0.73	0.76	0.79	0.83	0.86	0.89	0.92	0.95	0.98	
Dubbo	222	0.25	0.28	0.31	0.34	0.37	0.40	0.43	0.46	0.49	0.52	0.56	0.59	0.62	0.65	0.68	0.71	0.74	0.77	0.80	0.83	0.86	0.89	0.93	0.96	0.99	
Mittagong	222	0.25	0.28	0.31	0.34	0.37	0.40	0.43	0.46	0.49	0.52	0.56	0.59	0.62	0.65	0.68	0.71	0.74	0.77	0.80	0.83	0.86	0.89	0.93	0.96	0.99	
Riverstone	234	0.26	0.29	0.33	0.36	0.39	0.42	0.46	0.49	0.52	0.55	0.59	0.62	0.65	0.68	0.72	0.75	0.78	0.81	0.85	0.88	0.91	0.94	0.98	1.01	1.04	
Armidale	238	0.26	0.30	0.33	0.36	0.40	0.43	0.46	0.50	0.53	0.56	0.60	0.63	0.66	0.69	0.73	0.76	0.79	0.83	0.86	0.89	0.93	0.96	0.99	1.02	1.06	
Penrith	244	0.27	0.31	0.34	0.37	0.41	0.44	0.47	0.51	0.54	0.58	0.61	0.64	0.68	0.71	0.75	0.78	0.81	0.85	0.88	0.92	0.95	0.98	1.02	1.05	1.08	
Nowra	247	0.27	0.31	0.34	0.38	0.41	0.45	0.48	0.51	0.55	0.58	0.62	0.65	0.69	0.72	0.75	0.79	0.82	0.86	0.89	0.93	0.96	0.99	1.03	1.06	1.10	
Sydney	262	0.29	0.33	0.36	0.40	0.44	0.47	0.51	0.55	0.58	0.62	0.66	0.69	0.73	0.76	0.80	0.84	0.87	0.91	0.95	0.98	1.02	1.06	1.09	1.13	1.16	
Maitland	266	0.30	0.33	0.37	0.41	0.44	0.48	0.52	0.55	0.59	0.63	0.67	0.70	0.74	0.78	0.81	0.85	0.89	0.92	0.96	1.00	1.03	1.07	1.11	1.15	1.18	
Batemans Bay	268	0.30	0.34	0.37	0.41	0.45	0.48	0.52	0.56	0.60	0.63	0.67	0.71	0.74	0.78	0.82	0.86	0.89	0.93	0.97	1.01	1.04	1.08	1.12	1.15	1.19	
Lismore	270	0.30	0.34	0.38	0.41	0.45	0.49	0.53	0.56	0.60	0.64	0.68	0.71	0.75	0.79	0.83	0.86	0.90	0.94	0.98	1.01	1.05	1.09	1.13	1.16	1.20	
Kempsey	287	0.32	0.36	0.40	0.44	0.48	0.52	0.56	0.60	0.64	0.68	0.72	0.76	0.80	0.84	0.88	0.92	0.96	1.00	1.04	1.08	1.12	1.16	1.20	1.24	1.28	
Wollongong	308	0.34	0.39	0.43	0.47	0.51	0.56	0.60	0.64	0.68	0.73	0.77	0.81	0.86	0.90	0.94	0.98	1.03	1.07	1.11	1.16	1.20	1.24	1.28	1.33	1.37	
Gosford	313	0.35	0.39	0.43	0.48	0.52	0.57	0.61	0.65	0.70	0.74	0.78	0.83	0.87	0.91	0.96	1.00	1.04	1.09	1.13	1.17	1.22	1.26	1.30	1.35	1.39	
Port Macquarie	313	0.35	0.39	0.43	0.48	0.52	0.57	0.61	0.65	0.70	0.74	0.78	0.83	0.87	0.91	0.96	1.00	1.04	1.09	1.13	1.17	1.22	1.26	1.30	1.35	1.39	
Newcastle	316	0.35	0.40	0.44	0.48	0.53	0.57	0.61	0.66	0.70	0.75	0.79	0.83	0.88	0.92	0.97	1.01	1.05	1.10	1.14	1.19	1.23	1.27	1.32	1.36	1.40	
Kiama	319	0.35	0.40	0.44	0.49	0.53	0.58	0.62	0.66	0.71	0.75	0.80	0.84	0.89	0.93	0.97	1.02	1.06	1.11	1.15	1.20	1.24	1.28	1.33	1.37	1.42	
Wyong	320	0.36	0.40	0.44	0.49	0.53	0.58	0.62	0.67	0.71	0.76	0.80	0.84	0.89	0.93	0.98	1.02	1.07	1.11	1.16	1.20	1.24	1.29	1.33	1.38	1.42	
Tweed Heads	330	0.37	0.41	0.46	0.50	0.55	0.60	0.64	0.69	0.73	0.78	0.83	0.87	0.92	0.96	1.01	1.05	1.10	1.15	1.19	1.24	1.28	1.33	1.38	1.42	1.47	
Coffs Harbour	382	0.42	0.48	0.53	0.58	0.64	0.69	0.74	0.80	0.85	0.90	0.96	1.01	1.06	1.11	1.17	1.22	1.27	1.33	1.38	1.43	1.49	1.54	1.59	1.64	1.70	

NOTE: Values in the table are in L/s/m. A measure with a larger overflow volume can be substituted for one with a smaller volume.

- Slot area 720mm²/m - Overflow volume 0.3L/s/m
- Slot area 1200mm²/m - Overflow volume 0.5L/s/m
- **Stramit® Gutter Spacer** - Overflow volume 1.2L/s/m*
- **Stramit BAT® clip** - Overflow volume - 1.5L/s/m
- **Stramit Gutter Spacer** combined with Slot area 1200mm²/m - 1.7L/s/m or **Stramit BAT® clip** combined with slot area 720mm²/m - 1.8L/s/m

The above data is valid for Hi-Front Quad gutters. For other gutters, and for information on availability of different slot areas, please contact your local Stramit office for advice.

For gutters with a ribbed rather than hook back only, the data in the table for overflow where the **Stramit® Gutter Spacer** is used is valid for the installation of the gutters on the third notch of the snap clip or below. If overflow provisions are required where the gutter is on the top two notches and the **Stramit® Gutter Spacer** is used, please contact your local Stramit office for advice.

* Based on test results

STRAMIT® DOWNPIPES

Stramit Building Products offer a wide range of round and rectangular downpipes, each of which is tapered to permit easy assembly.

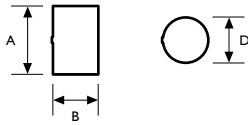

Sizing of minimum downpipe size relates only to the cross-sectional area of the chosen gutter. The table below gives the minimum round and rectangular downpipe size for each **Stramit®** Gutter.

STRAMIT® DOWNPIPES – MINIMUM SIZES (mm)		
Gutter Style	round* (diameter)	rectangular*
Stramit® Quad 115 Gutter	90	100 x 50
Stramit® Hi-Front Quad Gutter slotted / unslotted	90	100 x 50
Stramit® Quad 125 Gutter	90	100 x 50
Stramit Trline® HB and SB Gutter	100	100 x 75
Stramit® M Pattern Gutter slotted	100	100 x 75
unslotted	125	100 x 75
Stramit® S Pattern Gutter slotted	100	100 x 75
unslotted	125	100 x 75
Stramit® Half Round Gutter 150	100**	100 x 75**
Stramit® Flatback Gutter 150	100**	100 x 75**
Stramit® Half Round Gutter 200	150**	150 x 100**

* Smaller downpipes may be used provided the gutter capacity is reduced in drainage calculations.
 ** To be able to connect with these downpipes a specialist nozzle is required.

OTHER STRAMIT® RAINWATER & FLASHING PRODUCTS

Stramit® Custom Flashings

Stramit® Custom Flashings are available in an almost infinite variety of shapes and sizes. Preferred girth widths are 150, 250, 300 and 400mm and lengths of up to 8m are possible. The details of all **Stramit® Custom Flashings** must be provided in hard copy (e.g. fax). Contact the nearest Stramit branch for more details or refer to the NSW Price & Service Guide.

Stramit® Standard Flashings

All of the following products require nominally continuous support.



Stramit® Roll Top Ridge

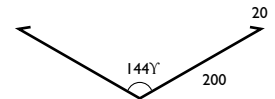

Stramit® Valley
(available plain or ribbed)

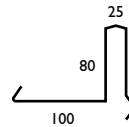

Stramit® Barge Gutter



Stramit® Edge Roll

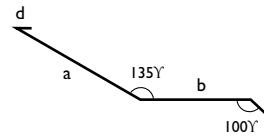

Stramit® Tile Flashing

STRAMIT® TILE FLASHING

	a	b	c	d
Ⓒ	130	130	20	10
Ⓔ	190	150	40	20
Ⓜ	130	130	30	10

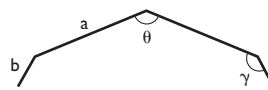

Stramit® Three Break Ridge

STRAMIT® THREE BREAK RIDGE

	a	b	θ	γ
Ⓒ	150	20	135°	165°
Ⓔ	185	40	155°	105°
Ⓜ	170	30	155°	115°

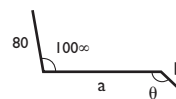

Stramit® Under Flashing

STRAMIT® UNDER FLASHING

	a	b	θ
Ⓒ	140	20	115°
Ⓔ	180	40	105°
Ⓜ	130	30	105°

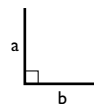

Stramit® Angle Flashings

STRAMIT® ANGLE FLASHING

a	b
50	50
100	100
150	100
150	150

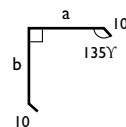

Stramit® Barge Angle

STRAMIT® BARGE ANGLE

	a	b
BA1	90	90
BA2	140	90
BA3	140	140

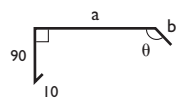

Stramit® Barge

STRAMIT® BARGE

	a	b	θ
Ⓒ	180	20	115°
Ⓔ	160	40	105°
Ⓜ	170	30	105°

- Ⓒ suits **Stramit® Corrugated** sheeting
- Ⓔ suits **Stramit Speed Deck Ultra®** decking
- Ⓜ suits **Stramit Monoclad®, Longspan®, Megaclad®** sheeting

Procurement

Accessories

Use only the correct, authentic **Stramit®** Accessories with **Stramit® Rainwater Products**.

The following accessories are available for each product:

Stramit® Fascia

- 45°/90° External Corners
- 45°/90° Internal Corner Caps
- Rafter Bracket
- Barge Bracket
- LH/RH Barge Corner
- Apex Cover Plate
- Splice Plate

Stramit® Quad Gutters

- Snap Clip
- Stramit® Gutter Spacer for overflow
- BAT® Overflow Clip (Hi-Front and Quad 115)
- Concealed Bracket*
- Nail Thru Gutter Stiffener* (Quad 115 only)
- Gutter Stiffener (for use with Snap Clip or BAT® Clip)
- External Bracket*
- Overstrap
- LH/RH Stop End Plates
- 45°/90° Internal Cast Angles
- 45°/90° External Cast Angles

Stramit® Fascia Gutters

- Snap Clip
- Concealed Bracket*
- Gutter Stiffener (for use with Snap Clip or BAT® Clip)
- Stop End Plates
- Overstrap (S Pattern only)

Stramit® Half Round Gutters

- Snap Clip (Flatback only)
- Gutter Stiffener (Flatback only)
- External Brackets* (150/200 only)
- Stop End Plates
- 45°/90° Internal Cast Angles
- 45°/90° External Cast Angles

Stramit® Downpipes

- Astragals/Stops
- Nozzles/Pops/Drops

Note that in most cases the components shown are different for each particular gutter style or downpipe size.

* Not suitable for use with metal fascia less than 1mm thick.

Associated products

- Roofing – wide range of profiles available.
- Roof & ceiling battens – range of top hats available.
- Flue & sewer accessories.
- Silicone – for all sealing requirements.
- Flashings & cappings – range of standard and custom flashings available.
- Rainwater heads – to suit most downpipe sizes.
- Edge roll – for neat edge finishing.

Prices

Prices of products can be obtained from your nearest Stramit location or distributor of **Stramit®** Products. As Stramit does not provide an installation service, ask your tradesperson for a supply and fix price. Contact your nearest Stramit location for the names of tradespeople in your area.

Handling/Storage

Stramit® Rainwater Products should be handled with care at all times to preserve the product capabilities and quality of the finish. Packs should always be kept dry and stored above ground level while on site. If the products become wet, they should be separated, wiped and placed in the open to promote drying.

Ordering

Stramit® Rainwater Products can be ordered directly through distributors, or supplied and fixed from an installer.

Lengths

Most rainwater products are available as stock lengths. **Stramit® Fascia**, gutters and valleys are available cut-to-length from Sydney.

Delivery/Unloading

Delivery can normally be made within 48 hours, subject to the delivery location and material availability, or can be at a pre-arranged date and time. Please ensure that suitable arrangements have been made for truck unloading, as this is the responsibility of the receiver. When lifting fascia gutter and flashings, care should be taken to ensure that the load is spread to prevent damage. The protective strippable coating on COLORBOND® steel product should not be exposed to sunlight for more than about one week or this may become difficult to remove.

Installation

Fasteners

All fastening screws must conform to AS3566 – Class 3.
For connecting brackets use:



For fixing **Stramit® Fascia** rafter brackets to steel trusses (up to 2.5mm)

– No. 10 x 16mm hex-head self drilling & threading screws.



– to timber trusses – No. 10 x 25mm hex-head type 17 self-drilling screws.

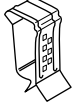

For fixing gutters to **Stramit® Fascia** – **Stramit®** Snap Clip (also requires a stiffener bracket), or

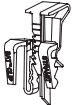

– **Stramit BAT®** Clip (also requires a stiffener bracket)



– **Stramit® Gutter Spacer**

– various lengths

– overflow provision



For fixing Gutter Brackets to timber fascia

– No. 10 x 25mm wafer head self-drilling type 17 screws, or



– 40mm galvanised fluted nails.



For lap joints and accessories

– 3.2mm diameter aluminium pop rivets.

Site Induction

Consideration should be given to handling and installation issues as part of site induction safety procedures. Specific consideration should be given to pack handling, avoidance of cuts, trips, slips and falls, long section handling particularly in windy conditions, section cutting procedures and surface temperature on sunny days. Personal Protection Equipment (PPE) should always be used.

Good Practice

Stramit recommends that good trade practice be followed when using the products such as that found in *Standard Australia Handbook – HB39*. “Installation code for metal roofing and wall cladding”.

Section Handling

Cut resistant or leather gloves should be worn when handling product. Foot protection should be worn when handling and transporting product.

Cutting

Stramit® Rainwater Products can be easily cut, where required, using a fine-toothed hacksaw and tin snips. Please dispose of any off-cuts carefully.

Sealing

Use only neutral-cure silicone for sealing joints when using **Stramit® Rainwater Products**. Take care to avoid pockets in joints which may hold moisture and potentially reduce durability.

Painting

Stramit® Rainwater Products are available in COLORBOND® steel colours. However should painting of Zinc Aluminium/Zinc Aluminium Magnesium coated steel products be required, use the following procedure.

A ‘weathering’ period of two weeks following installation will make painting easier. Clean the gutter/fascia immediately prior to painting. Dirt can be washed off using water with mild detergent. Any grease marks should be wiped away with paint thinners. In benign locations good quality acrylic paint will give satisfactory performance. First use a low-gloss water-borne acrylic primer. Finish with water-borne acrylic gloss (or your choice of gloss level).

WARNING – Never use paint thinners or other solvents on COLORBOND® steel surfaces.

Strippable Coating

Some **Stramit® Rainwater Products** are supplied with a protective strippable coating. This should be removed at the last possible stage during the installation process. It is possible to selectively move the coating to one side to avoid fastenings and joints. Then finally remove the coating from the installed product.

WARNING – Do not leave products with strippable coating exposed to direct sunlight for more than about a week or it can become difficult to remove.

Installation Steps

Stramit® Fascia

1. Cut **Stramit® Fascia** to suit a straight run.
2. Position and level rafter brackets near each end of the run (ensuring correct eave overhang and soffit height) and fix to the rafters.
3. Slide **Stramit® Fascia** over one end and slide along to the other end (or lift over brackets).
4. Insert remaining rafter brackets at required spacings and fix to rafters.
5. Repeat for each straight run, and then attach accessories.

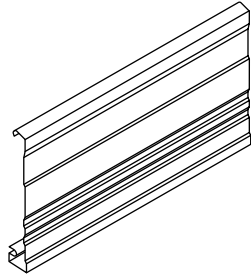

Stramit® Gutters

Select and implement overflow provisions - see pages 6, 7 and 10.

For each of the fascia type and bracket combinations shown, if using the **Stramit BAT® Overflow Clip** or other **Stramit® Gutter Spacer**:

- Remember to allow for the small increase in gutter cut length due to the offset.
- Fixing of pre-prepared or cast corners as in step 2 below should only be done after clips / brackets and stiffeners are fitted.

For concealed brackets or when fixing to timber fascia, provide a suitable spacer behind the bracket before fixing or adjust height to a level where gutter bead is 10mm below top of fascia.

For fixing to Stramit® Fascia:

If using **Stramit® Gutter Spacer** or **Stramit BAT® Clip**, see separate installation sheets available on our website.

1. Cut **Stramit® Gutter** to suit a straight run, including downpipe outlet holes and end mitres.

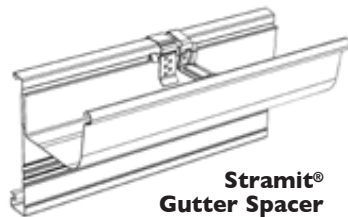

2. If using pre-prepared or cast corners these are generally installed first ensuring the correct height to allow for fall.

3. Push snap clips over fascia at no greater than maximum support spacing for the particular product.

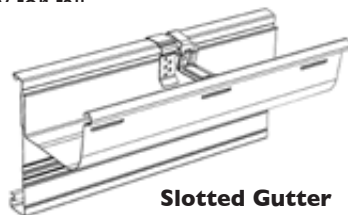

4. Push the back of the gutter under the snap clips to the lowest snap position.

5. Adjust the high point of the run to the desired position then apply the required fall (minimum 1 in 500) to the remainder of the gutter.
6. Attach a gutter stiffener bracket adjacent (within 50mm) to each snap clip.
7. Repeat for each straight run, and then attach accessories.

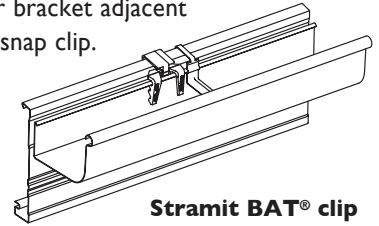

Stramit BAT® clip

For fixing to timber fascia using concealed brackets:

1. Cut **Stramit® Gutter** to suit a straight run, including downpipe outlet holes and end mitres.
2. If using pre-prepared or cast corners these are generally installed first ensuring the correct height to allow for fall.
3. Position and bracket at high end of the run and fix to the fascia.
4. Position and fix bracket at the other end of the run using a string line to set the required fall (minimum 1 in 500).
5. Position and fix intermediate brackets at no greater than maximum support spacing for the particular product.
6. Hook gutter to front of brackets, swing into position and fold down bracket tabs to secure, then for each fascia type.
7. Repeat for each straight run, and then attach accessories.

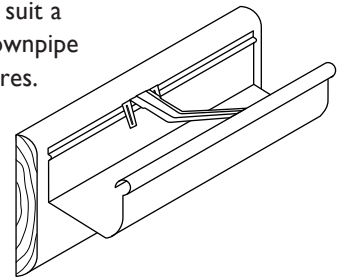

For fixing to timber fascia using external brackets:

1. Cut **Stramit® Gutter** to suit a straight run, including downpipe outlet holes and end mitres.
2. If using pre-prepared or cast corners these are generally installed first ensuring the correct height to allow for fall.
3. Position external bracket at the high end of the run and fix to the fascia.
4. Position and fix bracket at the low end of the run using a string line to set the required fall (minimum 1 in 500).
5. Using the string line as a guide position and fix intermediate brackets at no greater than maximum support spacing for the particular gutter.

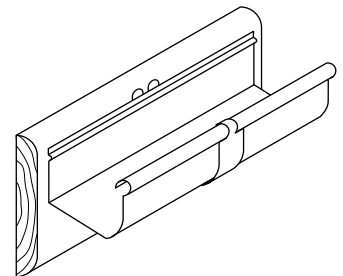

6. Place the gutter onto the brackets and secure in position by folding down the front (and back for some products) tabs.
7. Repeat for each straight run, and then attach accessories.

Stramit® Downpipes

1. Attach nozzle (pop/drop) to gutter (usually done prior to installing gutter).
2. Fit or construct the offset, preferably at an angle of at least 15° to ensure good drainage.
3. Adjust downpipe height to suit using taper or, if necessary, by cutting.
4. Secure downpipes to the wall using at least one astragal (downpipe strap) per downpipe length.
5. Attach downpipe shoe.

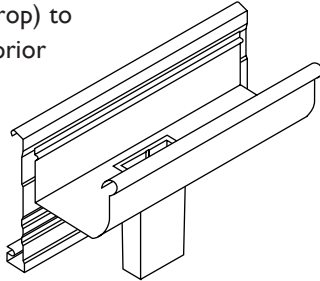

Additional Information

Maintenance

Gutters, downpipes and other parts of rainwater installations need to be kept free of leaves and debris to function effectively. Exterior surfaces of metal products unwashed by rain can benefit from occasional washing. These areas include portions of fascia and the underside of accompanying gutters.

Further Information

As well as the standard range of Technical Manuals, Installation Leaflets, Case Studies and other promotional literature, Stramit has a series of Guides to aid design.

These include:

- Roof Slope Guide
- Concealed Fixed Decking
- Foot Traffic Guide
- Roof and Wall Sheeting
- Lightweight Structural Sections
- Truss Components
- Gutters and Downpipes
- Custom Flashings
- Insulation Products

Other Products

Stramit offers a wide range of building products including:

- Purlins and Girts
- Formwork Decking
- Roof and Wall Sheeting
- Lightweight Structural Sections
- Truss Components
- Gutters and Downpipes
- Custom Flashings
- Insulating Products

Registered Designs

Stramit® Fascia, fascia bracket, all gutter stiffener brackets, **Stramit® Barge Gutter** and **Stramit Compact Gutter®** gutter are protected in Australia by registered designs.

References

In preparing this document reference has been made to:

- Standards Australia Handbook – HB39 (Installation code for metal roof and wall cladding)
- BlueScope Steel – Technical Bulletin TB-4 (Maintenance of Colorbond (pre-painted steel roofing))
- BlueScope Steel – Technical Bulletin TB-15 (Steel gutter and downpipe products - selection and use)



Building Products

The Stramit web page can be found at:

www.stramit.com.au

Details of many **Stramit**® products can also be seen on the AIA site 'Product Selector' at:

www.selector.com.au

contact numbers for information

		prices	availability	general	technical
			products coating colours	other	advice product data
SYDNEY 33-83 Quarry Rd, Erskine Park NSW 2759	phone fax	(02) 9834 0909 (02) 9834 0988		(02) 9834 0900 (02) 9834 0988	
CANBERRA 4 Bass Street, Queanbeyan NSW 2620	phone fax		(02) 6132 8300 (02) 6132 8333		
COFFS HARBOUR 6 Mansbridge Drive, Coffs Harbour NSW 2450	phone fax		(02) 6656 3800 (02) 6656 3808		
NEWCASTLE 17 Nelson Road, Cardiff NSW 2285	phone fax		(02) 4041 3400 (02) 4041 3423		
ORANGE 51 Leewood Drive, Orange NSW 2800	phone fax		(02) 6363 3900 (02) 6363 3911		
MELBOURNE 2/1464 Ferntree Gully Road, Knoxfield VIC 3180	phone fax	(03) 9237 6300 (03) 9237 6399		(03) 9237 6200 (03) 9237 6299	
ALBURY 18 Ariel Drive, Albury NSW 2640	phone fax		(02) 6041 7600 (02) 6041 7666		
BENDIGO Ramsay Court, Kangaroo Flat VIC 3555	phone fax		(03) 5448 6400 (03) 5447 9677		
HOBART 57 Crooked Billett Drive, Brighton TAS 7030	phone fax		(03) 6262 8888 (03) 6262 8812		(03) 6262 8888 (03) 6262 8812
ADELAIDE 11 Stock Road, Cavan SA 5094	phone fax		(08) 8262 4444 (08) 8262 6333		(08) 8262 4444 (08) 8262 6333
BRISBANE 57-71 Platinum Street, Crestmead QLD 4132	phone fax		(07) 3803 9999 (07) 3803 1499		
TOWNSVILLE 402-408 Bayswater Road, Garbutt QLD 4814	phone fax		(07) 4412 3900 (07) 4412 3909		
CAIRNS Vickers Street, Edmonton QLD 4869	phone fax		(07) 4034 6555 (07) 4034 6511		
MACKAY Brickworks Court, Glenella QLD 4740	phone fax		(07) 4965 4000 (07) 4965 4012		(07) 3803 9999 (07) 3803 1499
MARYBOROUGH 10 Activity St, Maryborough QLD 4650	phone fax		(07) 4123 9500 (07) 4123 9508		
ROCKHAMPTON 41 Johnson St, Parkhurst QLD 4702	phone fax		(07) 4921 5600 (07) 4921 5608		
DARWIN 55 Albatross Street, Winnellie NT 0820	phone fax		(08) 8930 6333 (08) 8930 6308		
PERTH 605-615 Bickley Road, Maddington WA 6109	phone fax		(08) 9493 8800 (08) 9493 8899		

™ and © Trademarks of Stramit Corporation Pty Limited. ABN 57 005 010 195 trading as Stramit Building Products

A member of the Fletcher Building Group

© Stramit Corporation Pty Limited. June 2016.

This document replaces all previous issues. Please destroy, or clearly mark as superseded, all previous issues.