



**G\*GRASS®**

**TAVINEA SORTO**  
INTERIOR ACCESSORY SYSTEM

The new compact frame  
system for GRASS drawers.  
Simple. Attractive. Tidy.





## Perfect framework for the organisation of drawers

**Whether you opt for one, two or three elements – with the Tavinea Sorto frame system, drawers of any width can be organised simply and quickly.**

The frame elements are assembled from 6 mm narrow metal profiles, the shape of which creates Tavineo Sorto's functional good looks. Purist sleek design, matt surfaces, timeless colours – the understated elegance of the frame system looks equally good in drawers in the kitchen, bathroom, living room and bedroom. The system's innovative corner connection is both spacer and anti-slip device.

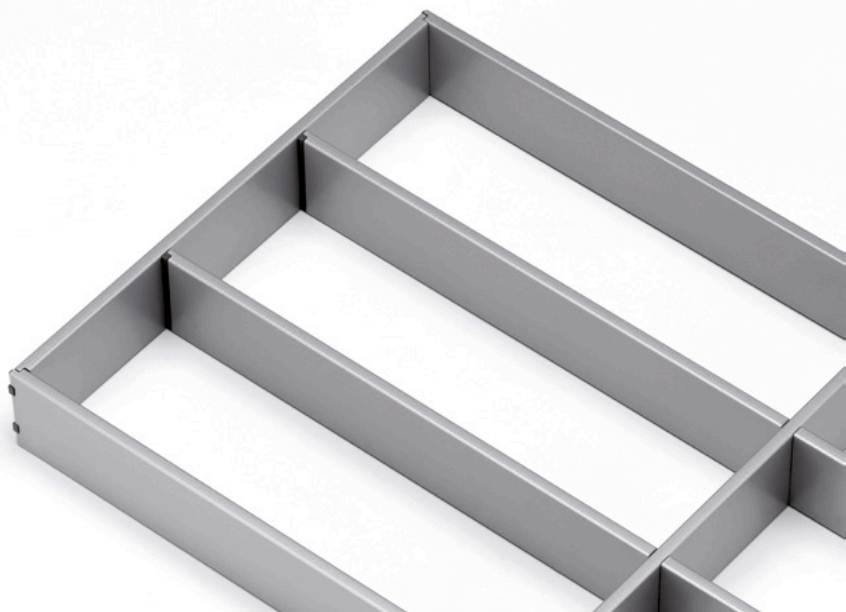

Knife block, foil holder or spice rack – with the appropriate additions, Tavinea Sorto becomes a comprehensive interior accessory system.

## TAVINEA SORTO INTERIOR ACCESSORY SYSTEM

Tavinea Sorto appeals with its purist design and straightforward system, which couldn't be simpler. The perfect partner for all GRASS drawer systems.



Whether Nova Pro, DWD XP or Vionaro – Tavinea Sorto is the ideal complement for all GRASS drawer systems. Material, shape, colour and surface are not just similar, but identical. To be precise – they are made of the same steel and coated with the same powder. This means that the interior accessory system harmoniously matches the colour of the drawer sides and, in combination, reveals its fascinating effect.

**GRASS drawer systems and Tavinea Sorto.  
Two that are really one.**

A spring device on the inside of the divider rail makes it possible to position the narrow longitudinal divider where needed. In that way, a single divider rail can be used to create two compartments or to hold accessories such as a knife block, foil holder or spice rack firmly in place.





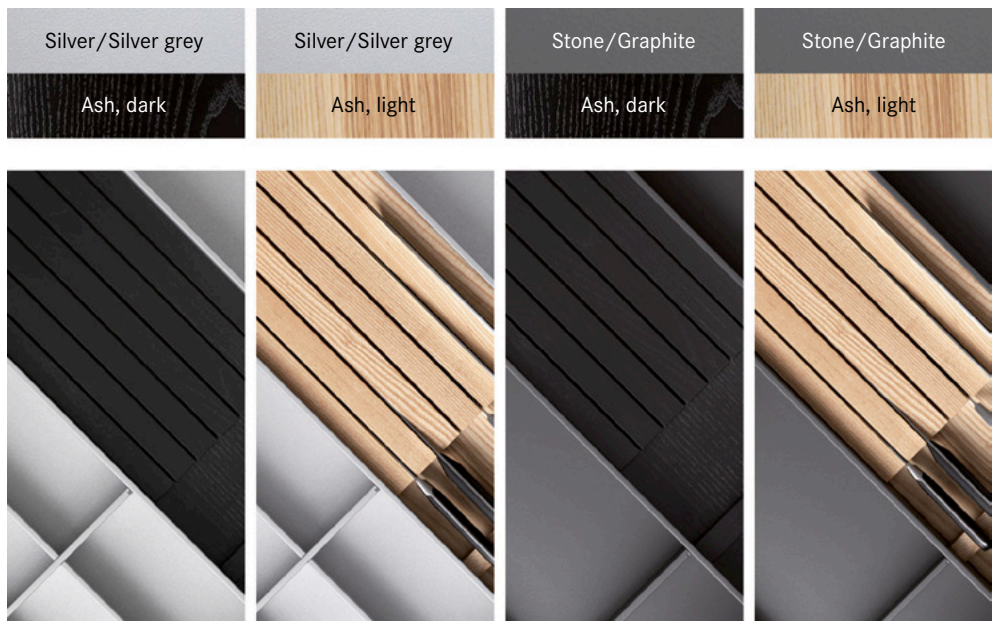

Now everything is  
where it should be.

The high-quality frame elements made of steel and the accessory parts made of wood organise the storage space of drawers in a particularly attractive way. The light-coloured wood combines especially well with dark colour shades, while dark ash is better suited to the silvery metal colours. Irrespective of the wood colour you choose, the combination of metal and wood means that Tavinea Sorto always has a dynamic and lively feel.

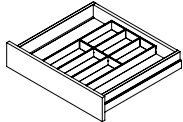

# TAVINEA SORTO

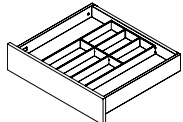
Perfect framework using the compact interior accessory system for drawers.

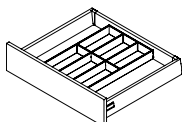
|  | Product description   |  | Page |
|--|---|--|------|
|   | <b>Tavinea Sorto for Nova Pro Scala</b> <ul style="list-style-type: none"><li>• Modular interior accessory system</li><li>• Perfect organisation for drawers with cutlery and small items</li><li>• High-quality frames and divider rails made of powder-coated steel</li></ul> |   | 6    |
|   | <b>Tavinea Sorto for Vionaro</b> <ul style="list-style-type: none"><li>• Modular interior accessory system</li><li>• Perfect organisation for drawers with cutlery and small items</li><li>• High-quality frames and divider rails made of powder-coated steel</li></ul>        |   | 12   |
|  | <b>Tavinea Sorto for DWD XP</b> <ul style="list-style-type: none"><li>• Modular interior accessory system</li><li>• Perfect organisation for drawers with cutlery and small items</li><li>• High-quality frames and divider rails made of powder-coated steel</li></ul>         |  | 18   |

# TAVINEA SORTO FOR NOVA PRO

Interior accessory system



- Perfect organisation for cutlery and small items
- High-quality frames and divider rails made of powder-coated steel
- Colour-coordinated
- Innovative anti-slip device ensures firm seating on the base panel

**Packaging unit (PU):**

201 = 1 unit in a cardboard box  
207 = 10 units in a cardboard box

**Notes:**

- Tavinea Sorto B186 can be used with cabinet widths from 300
- Tavinea Sorto B276 can be used with cabinet widths from 400

## ORDER INFORMATION

**1 Tavinea Sorto B186**  
Single item

| NL  | Stone      |     |  | Silver     |     |  |  |  |  |  |  |  |
|-----|------------|-----|--|------------|-----|--|--|--|--|--|--|--|
|     | Art.-no.   | PU  |  | Art.-no.   | PU  |  |  |  |  |  |  |  |
| 350 | F007130074 | 201 |  | F007130075 | 201 |  |  |  |  |  |  |  |
| 400 | F007130078 | 201 |  | F007130079 | 201 |  |  |  |  |  |  |  |
| 450 | F007130082 | 201 |  | F007130083 | 201 |  |  |  |  |  |  |  |
| 500 | F007130086 | 201 |  | F007130087 | 201 |  |  |  |  |  |  |  |
| 550 | F007130090 | 201 |  | F007130091 | 201 |  |  |  |  |  |  |  |
| 600 | F007130094 | 201 |  | F007130095 | 201 |  |  |  |  |  |  |  |
| 650 | F007130098 | 201 |  | F007130099 | 201 |  |  |  |  |  |  |  |

**2 Tavinea Sorto B276**  
Single item

| NL  | Stone      |     |  | Silver     |     |  |  |  |  |  |  |  |
|-----|------------|-----|--|------------|-----|--|--|--|--|--|--|--|
|     | Art.-no.   | PU  |  | Art.-no.   | PU  |  |  |  |  |  |  |  |
| 400 | F007130050 | 201 |  | F007130051 | 201 |  |  |  |  |  |  |  |
| 450 | F007130054 | 201 |  | F007130055 | 201 |  |  |  |  |  |  |  |
| 500 | F007130058 | 201 |  | F007130059 | 201 |  |  |  |  |  |  |  |
| 550 | F007130062 | 201 |  | F007130063 | 201 |  |  |  |  |  |  |  |
| 600 | F007130066 | 201 |  | F007130067 | 201 |  |  |  |  |  |  |  |
| 650 | F007130070 | 201 |  | F007130071 | 201 |  |  |  |  |  |  |  |

**3 Tavinea Sorto divider rail**  
Single item

| NL  | Stone      |     |  | Silver     |     |  |  |  |  |  |  |  |
|-----|------------|-----|--|------------|-----|--|--|--|--|--|--|--|
|     | Art.-no.   | PU  |  | Art.-no.   | PU  |  |  |  |  |  |  |  |
| 350 | F007130102 | 207 |  | F007130103 | 207 |  |  |  |  |  |  |  |
| 400 | F007130106 | 207 |  | F007130107 | 207 |  |  |  |  |  |  |  |
| 450 | F007130110 | 207 |  | F007130111 | 207 |  |  |  |  |  |  |  |
| 500 | F007130114 | 207 |  | F007130115 | 207 |  |  |  |  |  |  |  |
| 550 | F007130118 | 207 |  | F007130119 | 207 |  |  |  |  |  |  |  |
| 600 | F007130122 | 207 |  | F007130123 | 207 |  |  |  |  |  |  |  |
| 650 | F007130126 | 207 |  | F007130127 | 207 |  |  |  |  |  |  |  |

## PAGE REFERENCES

|                          |    |  |  |
|--------------------------|----|--|--|
| Accessories              | 8  |  |  |
| Installation information | 10 |  |  |

**1 Tavinea Sorto B186**



NL 350



NL 400 - 500



NL 550 - 650

**2 Tavinea Sorto B276**



NL 400



NL 450 - 500



NL 550 - 650

**3 Tavinea Sorto divider rail**



Tavinea Sorto accessories see page 8

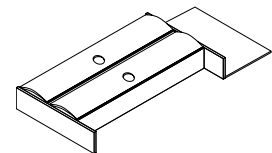
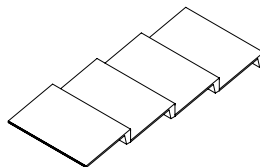
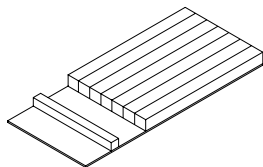

**LEGEND**

B Width  
KB Cabinet width  
NL Nominal length

# TAVINEA SORTO FOR NOVA PRO

## Accessories



- The right accessories for all requirements
- Knives, spice jars, cooking foil, cutlery or Eau de Toilette – with Tavinea Sorto accessories, everything has its perfect place
- High-quality materials: Aluminium and solid wood

### Packaging unit (PU):

201 = 1 unit in a cardboard box

### Note:

Accessories are hygiene-tested and non-toxic

## ORDER INFORMATION

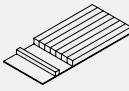
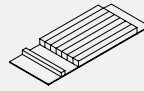
| 1 Knife block<br>Single item |  |     |  |     |                          |     |
|------------------------------|---|-----|---|-----|--------------------------|-----|
|                              | NL 450  | PU  | NL 500  | PU  | NL 550 <sup>1</sup>      | PU  |
| Light ash                    | F007108657  | 201 | F007101990  | 201 | F007101990<br>F007108659 | 201 |
| Dark ash                     | F007108658  | 201 | F007101995  | 201 | F007101995<br>F007108660 | 201 |

<sup>1</sup> NL 550 comprises a knife block and levelling element. Please order both article numbers.

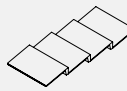
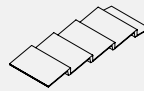
| 2 Spice rack<br>Single item |  |     |  |     |
|-----------------------------|---|-----|---|-----|
|                             | NL 500  | PU  | NL 550 <sup>1</sup>   | PU  |
| Light ash                   | F007101992  | 201 | F007101992<br>F007108659  | 201 |
| Dark ash                    | F007101997  | 201 | F007101997<br>F007108660  | 201 |

<sup>1</sup> NL 550 comprises a spice rack and levelling element. Please order both article numbers.

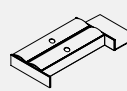
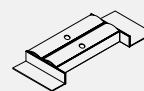
| 3 Foil holder<br>Single item |  |     |  |     |
|------------------------------|---|-----|---|-----|
|                              | NL 500  | PU  | NL 550 <sup>1</sup>   | PU  |
| Light ash                    | F007101994  | 201 | F007101994<br>F007108659  | 201 |
| Dark ash                     | F007101999  | 201 | F007101999<br>F007108660  | 201 |

<sup>1</sup> NL 550 comprises a foil holder and levelling element. Please order both article numbers.

## PAGE REFERENCES

|                          |    |
|--------------------------|----|
| Tavinea Sorto            | 6  |
| Installation information | 10 |



1 Knife block



2 Spice rack

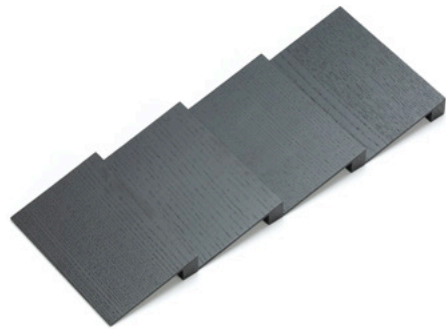

3 Foil holder



LEGEND

NL Nominal length

# TAVINEA SORTO FOR NOVA PRO

## Installation information

### APPLICATION EXAMPLES

KB 450

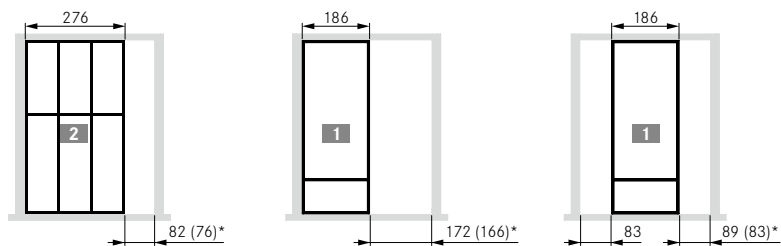
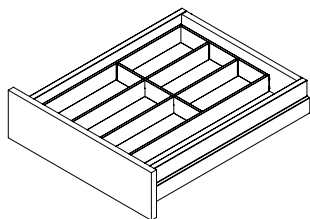

KB 600

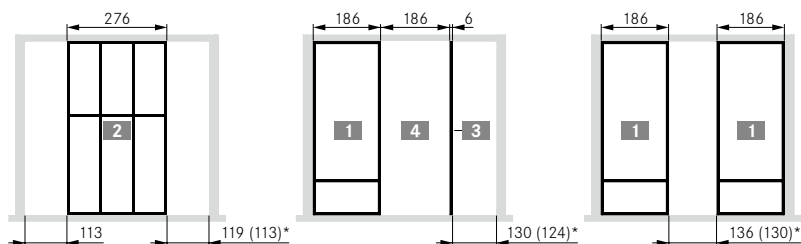
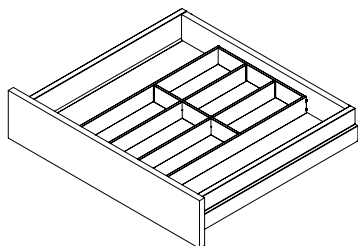

KB 900

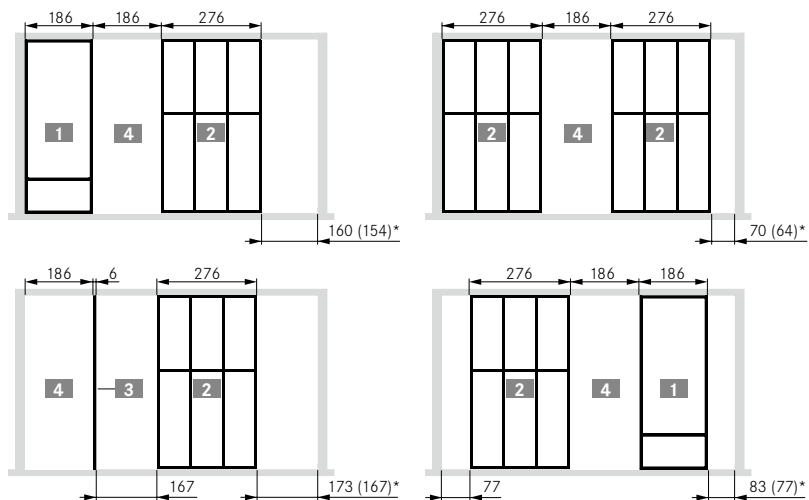
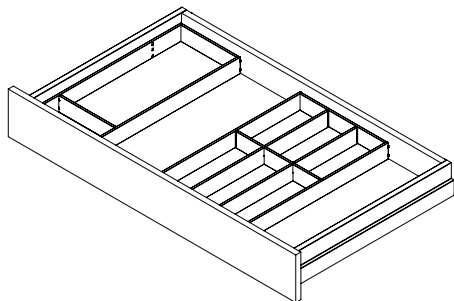

KB 1200

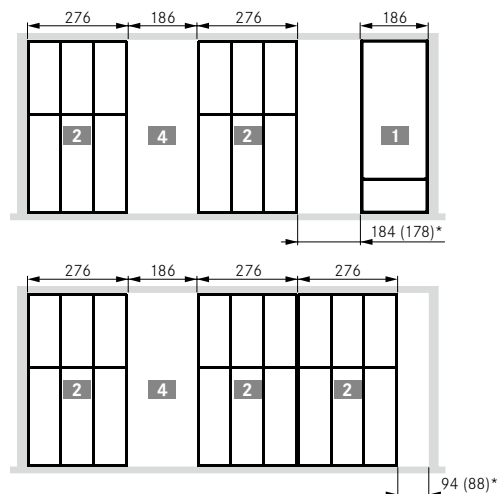
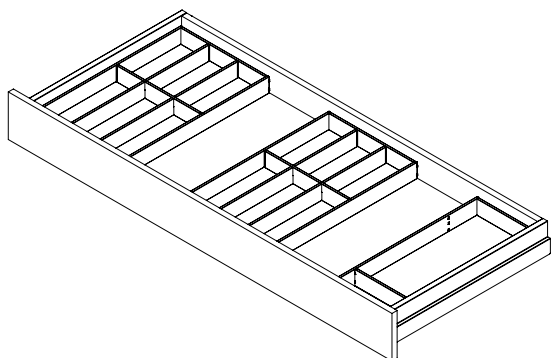

\* S16 (S18/S19)

APPLICATION EXAMPLE

**Description**

**1**

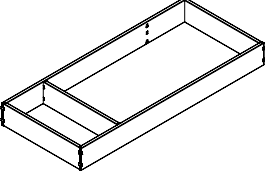

**2**

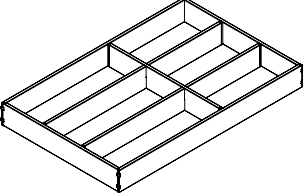

**3**

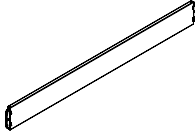

**4**

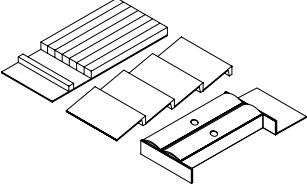

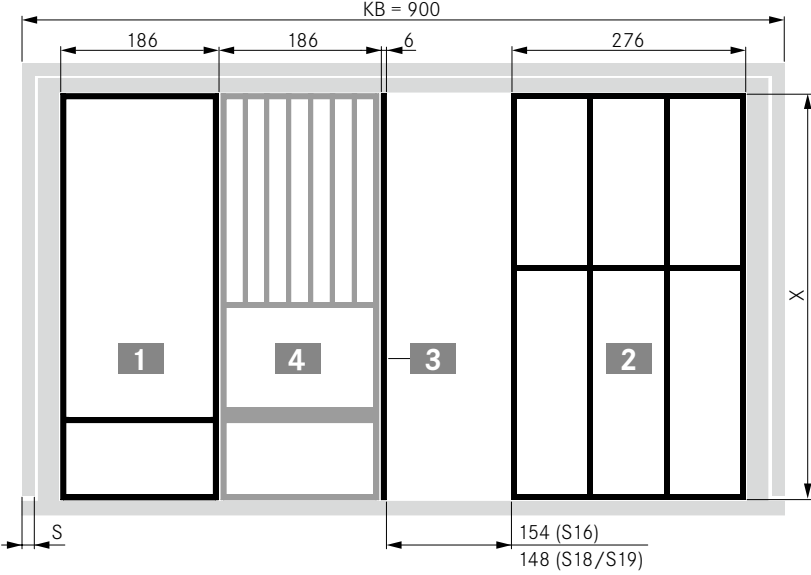

| NL  | X   |
|-----|-----|
| 350 | 329 |
| 400 | 379 |
| 450 | 429 |
| 500 | 479 |
| 550 | 530 |
| 600 | 580 |
| 650 | 630 |

INSTALLATION INFORMATION

**Description**

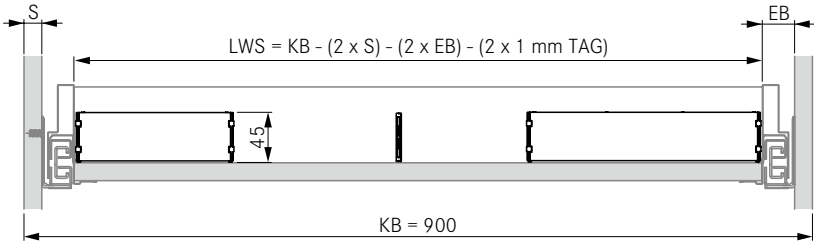

| S/EB                     | External cabinet width (KB) |     |     |     |     |     |     |      |      |      |
|--------------------------|-----------------------------|-----|-----|-----|-----|-----|-----|------|------|------|
|                          | 300                         | 400 | 500 | 600 | 700 | 800 | 900 | 1000 | 1100 | 1200 |
| 16/29                    | 208                         | 308 | 408 | 508 | 608 | 708 | 808 | 908  | 1008 | 1108 |
| 18/30                    | 202                         | 302 | 402 | 502 | 602 | 702 | 802 | 902  | 1002 | 1102 |
| 19/29                    |                             |     |     |     |     |     |     |      |      |      |
| Internal dimension (LWS) |                             |     |     |     |     |     |     |      |      |      |

LEGEND

|            |                    |            |                        |  |
|------------|--------------------|------------|------------------------|--|
| <b>EB</b>  | Construction width | <b>S</b>   | Cabinet side wall      |  |
| <b>KB</b>  | Cabinet width      | <b>TAG</b> | Tolerance compensation |  |
| <b>LWS</b> | Clear drawer width |            |                        |  |
| <b>NL</b>  | Nominal length     |            |                        |  |

# TAVINEA SORTO FOR VIONARO

Interior accessory system



- Perfect organisation for cutlery and small items
- High-quality frames and divider rails made of powder-coated steel
- Colour-coordinated
- Innovative anti-slip device ensures firm seating on the base panel

**Packaging unit (PU):**

201 = 1 unit in a cardboard box  
207 = 10 units in a cardboard box

**Notes:**

- Tavinea Sorto B186 can be used with cabinet widths from 300
- Tavinea Sorto B276 can be used with cabinet widths from 400

## ORDER INFORMATION

|                             |  |  |  |  |  |  |  |  |  |  |  |  |  |
|-----------------------------|--|--|--|--|--|--|--|--|--|--|--|--|--|
| <b>1 Tavinea Sorto B186</b> |  |  |  |  |  |  |  |  |  |  |  |  |  |
| Single item                 |  |  |  |  |  |  |  |  |  |  |  |  |  |

| NL  | Silver grey |     |  |  | Graphite   |     |  |  |  |  |  |  |
|-----|-------------|-----|--|--|------------|-----|--|--|--|--|--|--|
|     | Art.-no.    | PU  |  |  | Art.-no.   | PU  |  |  |  |  |  |  |
| 450 | F007130154  | 201 |  |  | F007130155 | 201 |  |  |  |  |  |  |
| 500 | F007130157  | 201 |  |  | F007130158 | 201 |  |  |  |  |  |  |
| 550 | F007130160  | 201 |  |  | F007130161 | 201 |  |  |  |  |  |  |
| 600 | F007130163  | 201 |  |  | F007130164 | 201 |  |  |  |  |  |  |
| 650 | F007130166  | 201 |  |  | F007130167 | 201 |  |  |  |  |  |  |

|                             |  |  |  |  |  |  |  |  |  |  |  |  |  |
|-----------------------------|--|--|--|--|--|--|--|--|--|--|--|--|--|
| <b>2 Tavinea Sorto B276</b> |  |  |  |  |  |  |  |  |  |  |  |  |  |
| Single item                 |  |  |  |  |  |  |  |  |  |  |  |  |  |

| NL  | Silver grey |     |  |  | Graphite   |     |  |  |  |  |  |  |
|-----|-------------|-----|--|--|------------|-----|--|--|--|--|--|--|
|     | Art.-no.    | PU  |  |  | Art.-no.   | PU  |  |  |  |  |  |  |
| 450 | F007130133  | 201 |  |  | F007130134 | 201 |  |  |  |  |  |  |
| 500 | F007130136  | 201 |  |  | F007130137 | 201 |  |  |  |  |  |  |
| 550 | F007130139  | 201 |  |  | F007130140 | 201 |  |  |  |  |  |  |
| 600 | F007130142  | 201 |  |  | F007130143 | 201 |  |  |  |  |  |  |
| 650 | F007130145  | 201 |  |  | F007130146 | 201 |  |  |  |  |  |  |

|                                     |  |  |  |  |  |  |  |  |  |  |  |  |  |
|-------------------------------------|--|--|--|--|--|--|--|--|--|--|--|--|--|
| <b>3 Tavinea Sorto divider rail</b> |  |  |  |  |  |  |  |  |  |  |  |  |  |
| Single item                         |  |  |  |  |  |  |  |  |  |  |  |  |  |

| NL  | Silver grey |     |  |  | Graphite   |     |  |  |  |  |  |  |
|-----|-------------|-----|--|--|------------|-----|--|--|--|--|--|--|
|     | Art.-no.    | PU  |  |  | Art.-no.   | PU  |  |  |  |  |  |  |
| 350 | F007130169  | 207 |  |  | F007130170 | 207 |  |  |  |  |  |  |
| 400 | F007130172  | 207 |  |  | F007130173 | 207 |  |  |  |  |  |  |
| 450 | F007130175  | 207 |  |  | F007130176 | 207 |  |  |  |  |  |  |
| 500 | F007130178  | 207 |  |  | F007130179 | 207 |  |  |  |  |  |  |
| 550 | F007130181  | 207 |  |  | F007130182 | 207 |  |  |  |  |  |  |
| 600 | F007130184  | 207 |  |  | F007130185 | 207 |  |  |  |  |  |  |
| 650 | F007130187  | 207 |  |  | F007130188 | 207 |  |  |  |  |  |  |

## PAGE REFERENCES

|                          |    |  |  |
|--------------------------|----|--|--|
| Accessories              | 14 |  |  |
| Installation information | 16 |  |  |

**1** Tavinea Sorto B186



NL 450 - 500



NL 550 - 650

**2** Tavinea Sorto B276

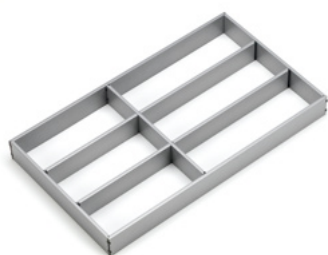

NL 450 - 500



NL 550 - 650

**3** Tavinea Sorto divider rail



Tavinea Sorto accessories see page 14

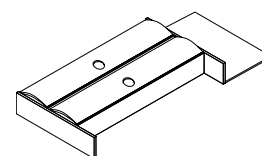
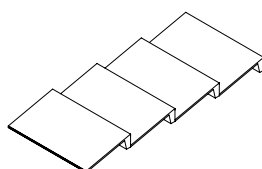
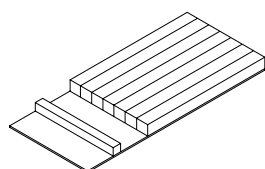

**LEGEND**

B Width  
KB Cabinet width  
NL Nominal length

# TAVINEA SORTO FOR VIONARO

## Accessories



- The right accessories for all requirements
- Knives, spice jars, cooking foil, cutlery or Eau de Toilette – with Tavinea Sorto accessories, everything has its perfect place
- High-quality materials: Aluminium and solid wood

### Packaging unit (PU):

201 = 1 unit in a cardboard box

### Note:

Accessories are hygiene-tested and non-toxic

## ORDER INFORMATION

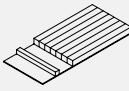
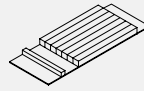
| 1 Knife block<br>Single item |  |     |  |     |                          |     |
|------------------------------|---|-----|---|-----|--------------------------|-----|
|                              | NL 450  | PU  | NL 500  | PU  | NL 550 <sup>1</sup>      | PU  |
| Light ash                    | F007108661  | 201 | F007102418  | 201 | F007102418<br>F007108659 | 201 |
| Dark ash                     | F007108662  | 201 | F007102424  | 201 | F007102424<br>F007108660 | 201 |

<sup>1</sup> NL 550 comprises a knife block and levelling element. Please order both article numbers.

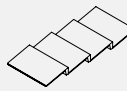
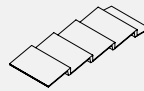
| 2 Spice rack<br>Single item |  |     |  |     |
|-----------------------------|---|-----|---|-----|
|                             | NL 500  | PU  | NL 550 <sup>1</sup>   | PU  |
| Light ash                   | F007102420  | 201 | F007102420<br>F007108659  | 201 |
| Dark ash                    | F007102426  | 201 | F007102426<br>F007108660  | 201 |

<sup>1</sup> NL 550 comprises a spice rack and levelling element. Please order both article numbers.

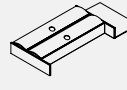
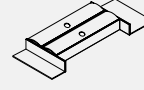
| 3 Foil holder<br>Single item |  |     |  |     |
|------------------------------|---|-----|---|-----|
|                              | NL 500  | PU  | NL 550 <sup>1</sup>   | PU  |
| Light ash                    | F007102422  | 201 | F007102422<br>F007108659  | 201 |
| Dark ash                     | F007102428  | 201 | F007102428<br>F007108660  | 201 |

<sup>1</sup> NL 550 comprises a foil holder and levelling element. Please order both article numbers.

## PAGE REFERENCES

|                          |    |
|--------------------------|----|
| Tavinea Sorto            | 12 |
| Installation information | 16 |

1 Knife block



2 Spice rack

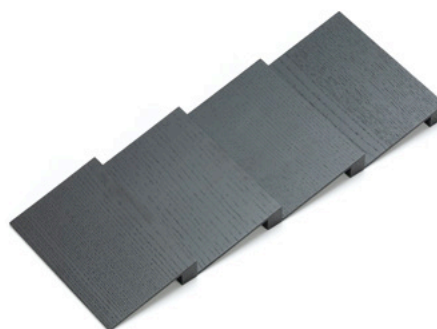

3 Foil holder



LEGEND

NL Nominal length

# TAVINEA SORTO FOR VIONARO

Installation information

## APPLICATION EXAMPLES

KB 450

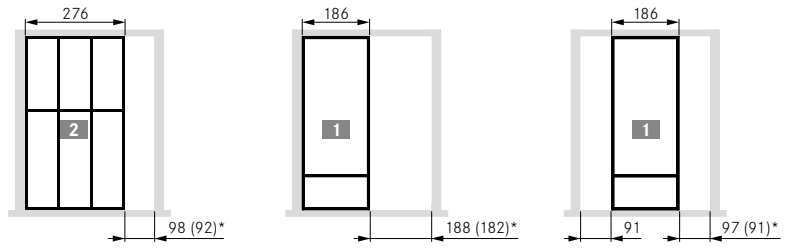
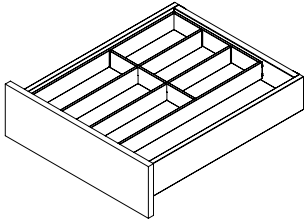

KB 600

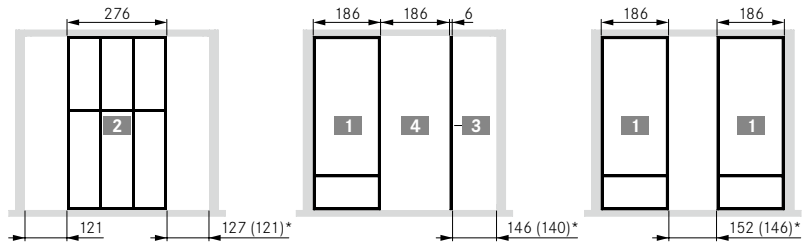
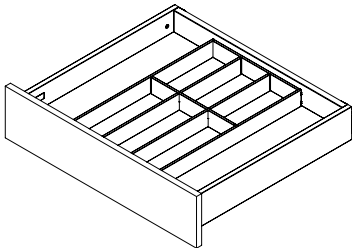

KB 900

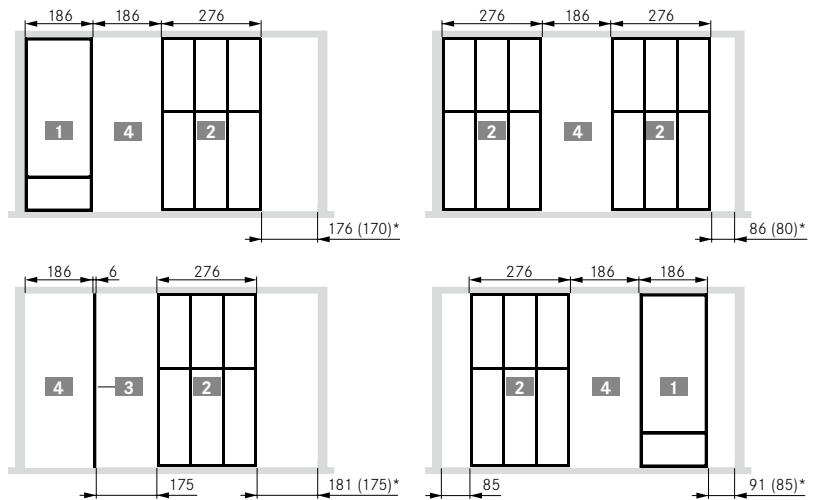
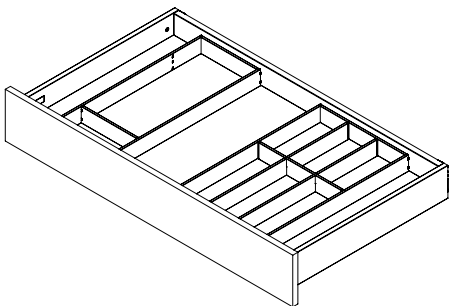

KB 1200

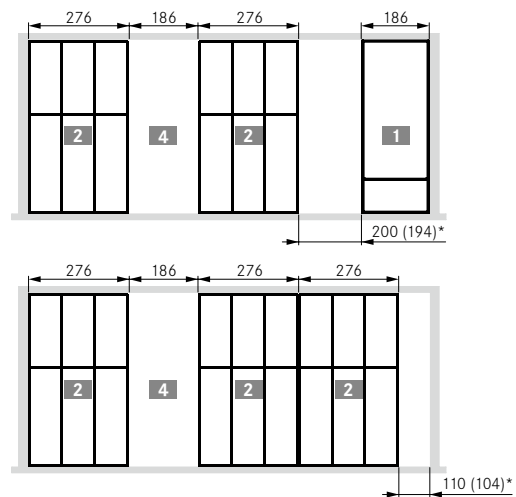
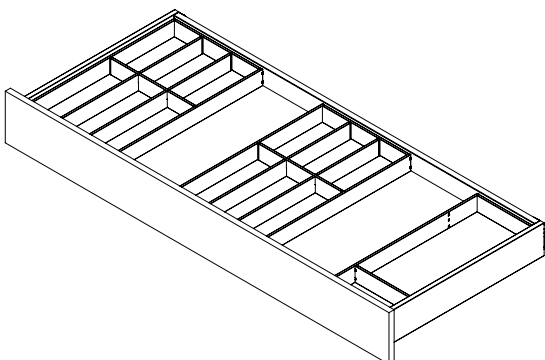

\* S16 (S19)



APPLICATION EXAMPLE

**Description**

**1**

**2**

**3**

**4**

| NL  | X   |
|-----|-----|
| 350 | 322 |
| 400 | 372 |
| 450 | 422 |
| 500 | 472 |
| 550 | 523 |
| 600 | 573 |
| 650 | 623 |

INSTALLATION INFORMATION

**Description**

| S                        | External cabinet width (KB) |     |     |     |     |     |     |      |      |      |
|--------------------------|-----------------------------|-----|-----|-----|-----|-----|-----|------|------|------|
|                          | 300                         | 400 | 500 | 600 | 700 | 800 | 900 | 1000 | 1100 | 1200 |
| 16                       | 224                         | 324 | 424 | 524 | 624 | 724 | 824 | 924  | 1024 | 1124 |
| 18                       | 220                         | 320 | 420 | 520 | 620 | 720 | 820 | 920  | 1020 | 1120 |
| 19                       | 218                         | 318 | 418 | 518 | 618 | 718 | 818 | 918  | 1018 | 1118 |
| Internal dimension (LWS) |                             |     |     |     |     |     |     |      |      |      |

LEGEND

|            |                    |            |                        |
|------------|--------------------|------------|------------------------|
| <b>KB</b>  | Cabinet width      | <b>TAG</b> | Tolerance compensation |
| <b>LWS</b> | Clear drawer width |            |                        |
| <b>NL</b>  | Nominal length     |            |                        |
| <b>S</b>   | Cabinet side wall  |            |                        |

# TAVINEA SORTO FOR DWD XP

Interior accessory system



- Perfect organisation for cutlery and small items
- High-quality frames and divider rails made of powder-coated steel
- Innovative anti-slip device ensures firm seating on the base panel

**Packaging unit (PU):**

201 = 1 unit in a cardboard box  
207 = 10 units in a cardboard box

**Notes:**

- Tavinea Sorto B186 can be used with cabinet widths from 300
- Tavinea Sorto B276 can be used with cabinet widths from 400

## ORDER INFORMATION

| 1 Tavinea Sorto B186<br>Single item |             |     |  |  |            |     |  |  |  |  |  |  |  |
|-------------------------------------|-------------|-----|--|--|------------|-----|--|--|--|--|--|--|--|
| NL                                  | Silver grey |     |  |  | Graphite   |     |  |  |  |  |  |  |  |
|                                     | Art.-no.    | PU  |  |  | Art.-no.   | PU  |  |  |  |  |  |  |  |
| 450                                 | F007130154  | 201 |  |  | F007130155 | 201 |  |  |  |  |  |  |  |
| 500                                 | F007130157  | 201 |  |  | F007130158 | 201 |  |  |  |  |  |  |  |
| 550                                 | F007130160  | 201 |  |  | F007130161 | 201 |  |  |  |  |  |  |  |
| 600                                 | F007130163  | 201 |  |  | F007130164 | 201 |  |  |  |  |  |  |  |
| 650                                 | F007130166  | 201 |  |  | F007130167 | 201 |  |  |  |  |  |  |  |

| 2 Tavinea Sorto B276<br>Single item |             |     |  |  |            |     |  |  |  |  |  |  |  |
|-------------------------------------|-------------|-----|--|--|------------|-----|--|--|--|--|--|--|--|
| NL                                  | Silver grey |     |  |  | Graphite   |     |  |  |  |  |  |  |  |
|                                     | Art.-no.    | PU  |  |  | Art.-no.   | PU  |  |  |  |  |  |  |  |
| 450                                 | F007130133  | 201 |  |  | F007130134 | 201 |  |  |  |  |  |  |  |
| 500                                 | F007130136  | 201 |  |  | F007130137 | 201 |  |  |  |  |  |  |  |
| 550                                 | F007130139  | 201 |  |  | F007130140 | 201 |  |  |  |  |  |  |  |
| 600                                 | F007130142  | 201 |  |  | F007130143 | 201 |  |  |  |  |  |  |  |
| 650                                 | F007130145  | 201 |  |  | F007130146 | 201 |  |  |  |  |  |  |  |

| 3 Tavinea Sorto divider rail<br>Single item |             |     |  |  |            |     |  |  |  |  |  |  |  |
|---|-------------|-----|--|--|------------|-----|--|--|--|--|--|--|--|
| NL  | Silver grey |     |  |  | Graphite   |     |  |  |  |  |  |  |  |
|   | Art.-no.    | PU  |  |  | Art.-no.   | PU  |  |  |  |  |  |  |  |
| 350   | F007130169  | 207 |  |  | F007130170 | 207 |  |  |  |  |  |  |  |
| 400   | F007130172  | 207 |  |  | F007130173 | 207 |  |  |  |  |  |  |  |
| 450   | F007130175  | 207 |  |  | F007130176 | 207 |  |  |  |  |  |  |  |
| 500   | F007130178  | 207 |  |  | F007130179 | 207 |  |  |  |  |  |  |  |
| 550   | F007130181  | 207 |  |  | F007130182 | 207 |  |  |  |  |  |  |  |
| 600   | F007130184  | 207 |  |  | F007130185 | 207 |  |  |  |  |  |  |  |
| 650   | F007130187  | 207 |  |  | F007130188 | 207 |  |  |  |  |  |  |  |

## PAGE REFERENCES

|                          |    |  |  |
|--------------------------|----|--|--|
| Accessories              | 20 |  |  |
| Installation information | 22 |  |  |
|                          |    |  |  |

**1 Tavinea Sorto B186**



NL 450 - 500



NL 550 - 650

**2 Tavinea Sorto B276**



NL 450 - 500



NL 550 - 650

**3 Tavinea Sorto divider rail**



Tavinea Sorto accessories see page 20

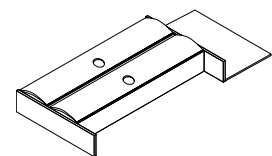
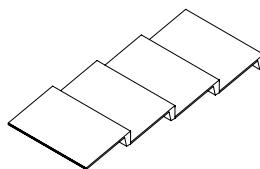
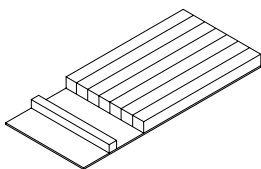

**LEGEND**

B Width  
KB Cabinet width  
NL Nominal length

# TAVINEA SORTO FOR DWD XP

## Accessories



- The right accessories for all requirements
- Knives, spice jars, cooking foil, cutlery or Eau de Toilette – with Tavinea Sorto accessories, everything has its perfect place
- High-quality materials: Aluminium and solid wood

### Packaging unit (PU):

201 = 1 unit in a cardboard box

### Note:

Accessories are hygiene-tested and non-toxic

## ORDER INFORMATION

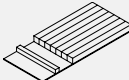
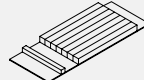
| 1 Knife block<br>Single item |  |     |  |     |                          |     |
|------------------------------|---|-----|---|-----|--------------------------|-----|
|                              | NL 450  | PU  | NL 500  | PU  | NL 550 <sup>1</sup>      | PU  |
| Light ash                    | F007108661  | 201 | F007102418  | 201 | F007102418<br>F007108659 | 201 |
| Dark ash                     | F007108662  | 201 | F007102424  | 201 | F007102424<br>F007108660 | 201 |

<sup>1</sup> NL 550 comprises a knife block and levelling element. Please order both article numbers.

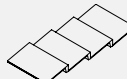
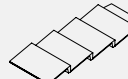
| 2 Spice rack<br>Single item |  |     |  |     |
|-----------------------------|---|-----|---|-----|
|                             | NL 500  | PU  | NL 550 <sup>1</sup>   | PU  |
| Light ash                   | F007102420  | 201 | F007102420<br>F007108659  | 201 |
| Dark ash                    | F007102426  | 201 | F007102426<br>F007108660  | 201 |

<sup>1</sup> NL 550 comprises a spice rack and levelling element. Please order both article numbers.

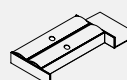
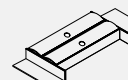
| 3 Foil holder<br>Single item |  |     |  |     |
|------------------------------|---|-----|---|-----|
|                              | NL 500  | PU  | NL 550 <sup>1</sup>   | PU  |
| Light ash                    | F007102422  | 201 | F007102422<br>F007108659  | 201 |
| Dark ash                     | F007102428  | 201 | F007102428<br>F007108660  | 201 |

<sup>1</sup> NL 550 comprises a foil holder and levelling element. Please order both article numbers.

## PAGE REFERENCES

|                          |    |
|--------------------------|----|
| Tavinea Sorto            | 18 |
| Installation information | 22 |

1 Knife block



2 Spice rack

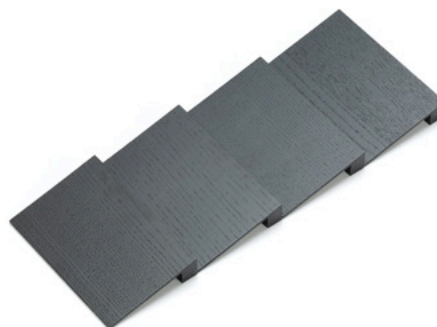

3 Foil holder



LEGEND

NL Nominal length

# TAVINEA SORTO FOR DWD XP

## Installation information

### APPLICATION EXAMPLES

#### KB 450

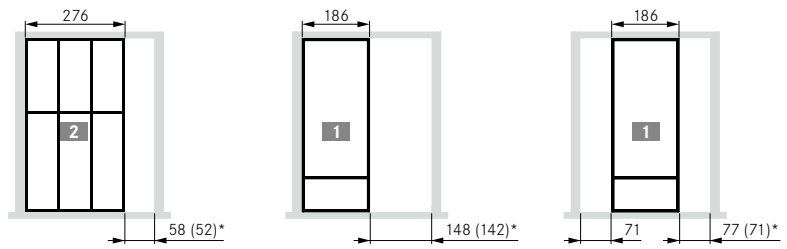
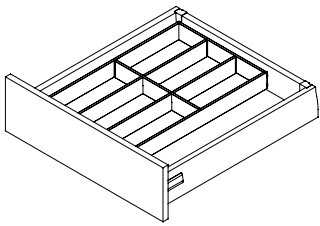

#### KB 600

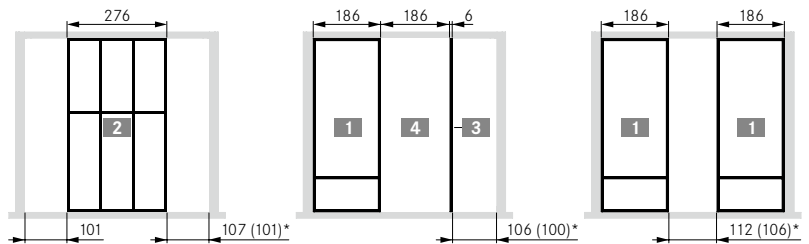
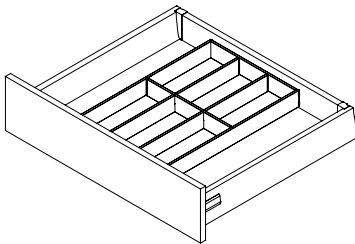

#### KB 900

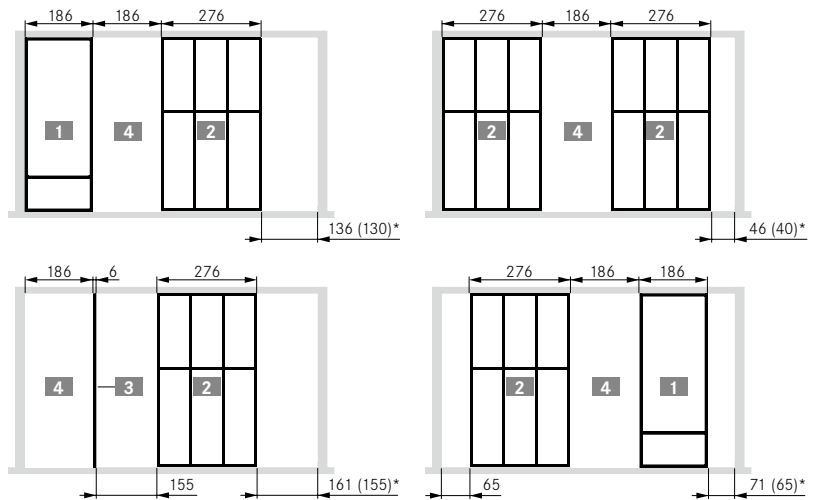
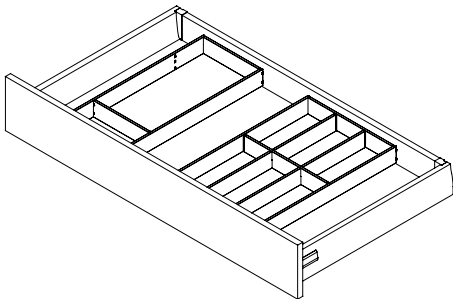

#### KB 1200

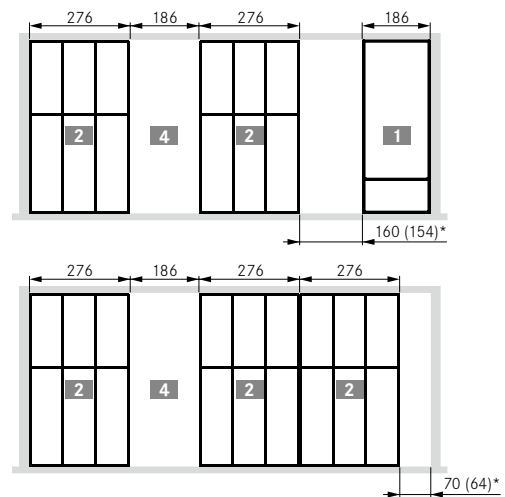
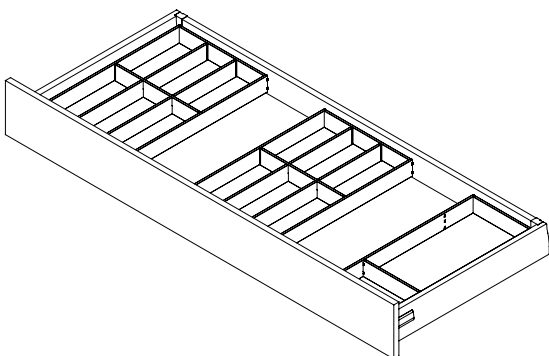

\* S16 (S19)

APPLICATION EXAMPLE

**Description**

**1**

**2**

**3**

**4**

| NL  | X   |
|-----|-----|
| 350 | 322 |
| 400 | 372 |
| 450 | 422 |
| 500 | 472 |
| 550 | 523 |
| 600 | 573 |
| 650 | 623 |

INSTALLATION INFORMATION

**Description**

| S                        | External cabinet width (KB) |     |     |     |     |     |     |      |      |      |
|--------------------------|-----------------------------|-----|-----|-----|-----|-----|-----|------|------|------|
|                          | 300                         | 400 | 500 | 600 | 700 | 800 | 900 | 1000 | 1100 | 1200 |
| 16                       | 184                         | 284 | 384 | 484 | 584 | 684 | 784 | 884  | 984  | 1084 |
| 18                       | 180                         | 280 | 380 | 480 | 580 | 680 | 780 | 880  | 980  | 1080 |
| 19                       | 178                         | 278 | 378 | 478 | 578 | 678 | 778 | 878  | 978  | 1078 |
| Internal dimension (LWS) |                             |     |     |     |     |     |     |      |      |      |

LEGEND

|            |                    |            |                        |
|------------|--------------------|------------|------------------------|
| <b>KB</b>  | Cabinet width      | <b>TAG</b> | Tolerance compensation |
| <b>LWS</b> | Clear drawer width |            |                        |
| <b>NL</b>  | Nominal length     |            |                        |
| <b>S</b>   | Cabinet side wall  |            |                        |



GRASS GmbH  
Movement Systems  
Grass Platz 1  
6973 Höchst, Austria  
T +43 5578 701-0  
F +43 5578 701-59  
info@grass.eu

Distributor contact: