

INSTALLATION GUIDE

25mm Range Two-Piece Batten

Achieve effortless architectural style with the cool, clean and contemporary lines of DecoBatten.

The light-weight aluminium battens replicate the form, feel and appearance of real timber thanks to the Super Durable™ DecoWood finish, offering a dimensionally stable, long-lasting timber alternative. DecoBatten allows for complete design flexibility and is suitable for a wide range of applications.



DecoBatten Design Options

DecoBatten comes in two easy-to-install systems: the standard One-Piece system and the Two-Piece 'Quick Click' system. Both systems are available in a wide range of shapes and sizes and allow for multiple installation methods. One-Piece battens are generally used when fixing battens from behind and when fixings can be easily hidden. The Two-Piece 'Quick Click' system has been designed for easier and quicker installations of more difficult applications (walls, ceilings, etc) or where a seamless concealed fixing is desired.

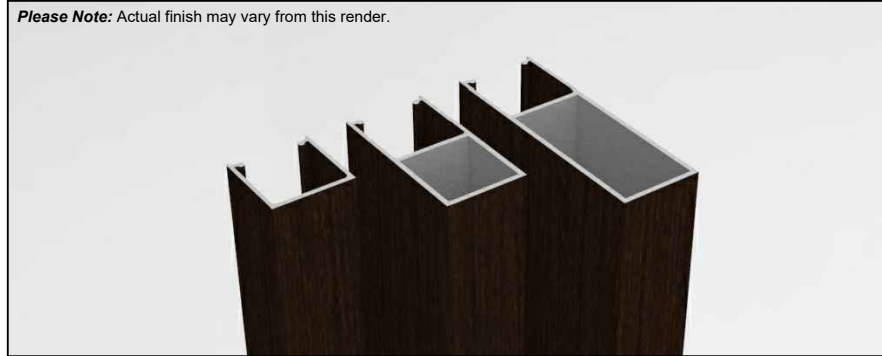
25mm Range Batten



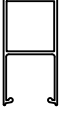

Please Note: Actual finish may vary from this render.

 25 x 25 DB02-25	 25 x 50 DB02-50	 25 x 75 DB02-75
--	--	--

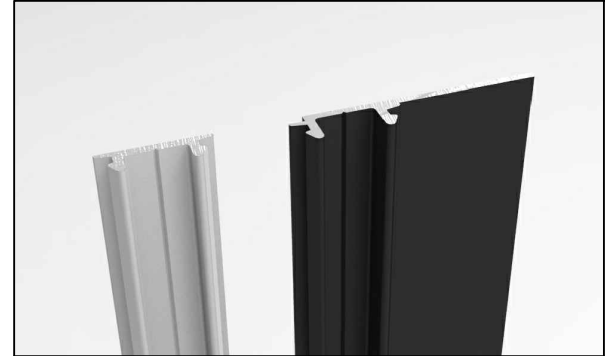
25/50mm Range Batten Base



 25mm Base DB02-B	 25mm SpaceBase DB02-SB
---	---

All DecoBatten and accessories are supplied in 6.5m lengths. As part of the manufacturing process, the first 10mm of both ends of the extrusion are taped and not imaged, therefore each board will need to be trimmed by 15mm on each end to remove the tape and provide a clean finish. After the removal of each end, the useable length is 6.47m.

Please note: The usable length might be vary depending on the chosen finishes; please contact and discuss with your DECO representative for more information.

Performance

As part of DECO's commitment to offering compliant building products, the DecoBatten systems have been designed to meet Australia's stringent building standards. The DecoBatten range has been tested to and passed the following standards:

DecoBatten - Tested Performance Data		
Description	Standard	Testing Body
Methods for fire tests on building materials, components and structures - Combustibility test for materials	AS1530.1	CSIRO
Methods for fire tests on building materials, components and structures - Simultaneous determination of ignitability, flame propagation, heat release and smoke release	AS/NZS1530.3	CSIRO
Method of test for heat and smoke release rates for materials and products using an oxygen consumption calorimeter	AS3837	CSIRO
DecoBatten - Assessed Performance Data		
Clause	Assessment Outcome	
NCC 2019 - Volume 1 - Clause C1.9 Non-Combustible building elements	Compliant	

Please Note: All testing has been undertaken using the detail provided in this installation guide and in order to claim the performances set out here within, the detail in this guide must be followed.

Engineering Performance

Due to the extensive installation methods in which the DecoBatten systems can be applied, and the different requirements of each building type and location, it is recommended that users consult with their Architect, Engineer, Building Designer and Building Surveyor to ensure that the installation detail will suit the local regulations and requirements.

WARRANTY FOR DECO PRODUCTS AND FINISHES

DECO Australia warrants that DECO finishes have been applied in accordance with the Australian Standard for Architectural Powder Coating AS 3715. The warranty is for 12 years and is subject to the provisions set out in AS 3715, including maintenance and cleaning, as set out in Appendix C of the standard.

Please Note: that if a formal warranty certificate is required, then this must be applied for at the time of order. This is because the standard AS3715 requires DECO Australia to process specimens for testing and reference at the same time as the job is processed. A warranty application form can be obtained by contacting DECO Australia by phone or email.

Contact your DECO representative on (02) 9603 1888 for more information.

Please Note: The design of our Two-Piece batten systems may vary. The click, fixing and securing detail of each system may vary based on the design and product availability. Please discuss the specific details of each design with your DECO representative.

Intellectual Property

This document and the information contained within it are copyright and confidential to DECO Australia. Disclosure, use and copying in any form, except as authorised by DECO Australia in writing are prohibited. Patents and Design Registrations Pending.

DecoBatten End Caps

As a part of the DecoBatten range, End Caps are available to match your chosen batten profile. End Caps are available in colour-matched aluminium or black plastic for both the One-Piece and Two-Piece batten systems. NB: Depending on the selected profile, End Caps will be one of two types; extruded aluminium for 50mm and 25mm wide profiles or press-fit aluminium for all other profiles.

Extruded Aluminium End Caps

Extruded aluminium End Caps are available for selected One-Piece and Two-Piece batten systems. Depending on the profile, the End Cap will be machined so that two legs fit into the profile and can be secured using a high-quality adhesive or mechanical fixings.

End Cap for One-Piece 50 x 50 Batten

End Cap Securing Options

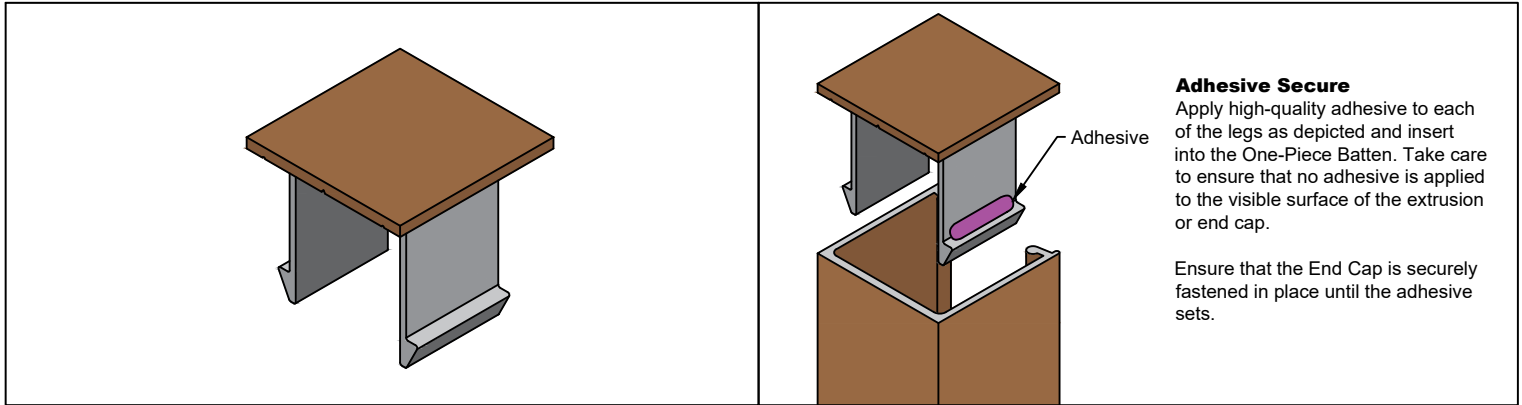

Plasterboard Fixing

Plasterboard screws are strongly recommended while installing 25mm Two-Piece battens onto a plasterboard backing. The countersunk heads of these screws provides a suitable grip to hold the battens in place against the plasterboard. **Please Note:** This is available on request, please contact and discuss with your DECO representative for more information.

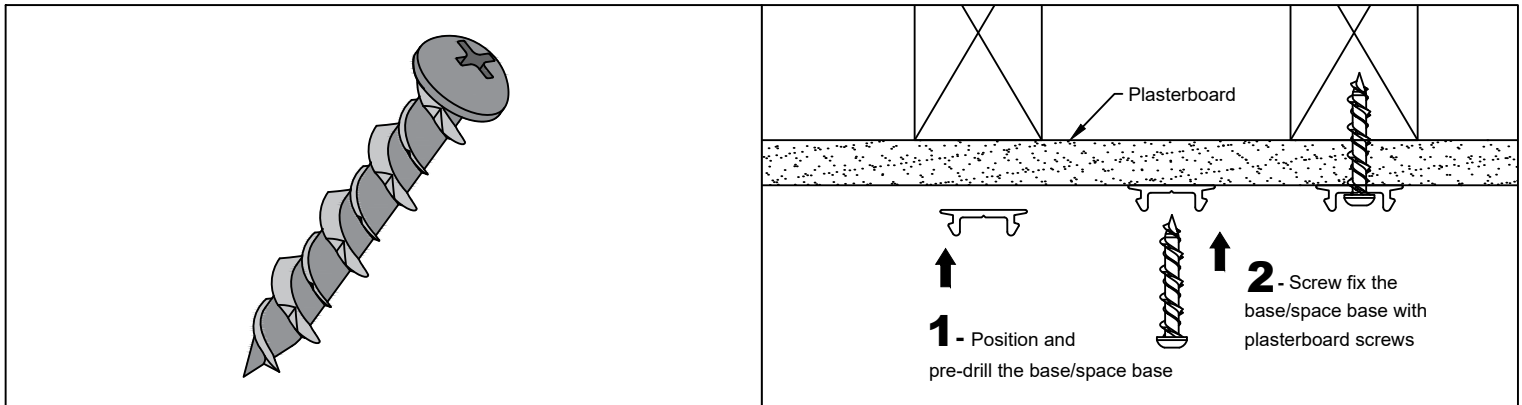

Preparation

Installation Surface

When installing DecoBatten care should be taken to ensure the installation surface has been prepared adequately to ensure that it is fit for the intended purpose. The surface should also be clean and flat, and preparations (such as backing colour) should be applied before the installation of DecoBatten products.

Supporting Structure and Fixings

Before installing any DecoBatten products the supporting structure should be assessed to ensure that it is structurally sound and able to support live and dead loads of the DecoBatten products that are to be installed. When fixing DecoBatten products, it is recommended that they are fixed at minimum 600mm centres when applied to a solid backing or 450mm centres when applied to framing, however due to the wide variety of installation applications, this may not be required for all applications. DECO recommends that users contact a certified Engineer to assess the supporting structure and fixings required when installing DecoBatten, especially in high-wind and high-risk areas.

Processing of DecoBatten

WARNING - When processing DecoBatten care should be taken and appropriate Personal Protective Equipment should be worn at all times. Failure to do so risks potential serious injury, disablement or death. When processing DecoBattens, care should be taken to ensure that the work space is clean and free from dust, sawdust, metal fines and/or shavings. Processing of the DecoBatten in areas with excessive dust, sawdust, metal fines and/or shavings risks potential damage to the finished surface.

STEP 1 - Apply the Two-Piece Batten Base to the Supporting Structure and Fix as Required

If the batten is to be installed flush to an end surface, ensure at least 3mm of clearance are provided to allow the batten cover to click over the base. To ensure a straight, consistent and parallel installation, it is strongly recommended that a level is used to position each base.

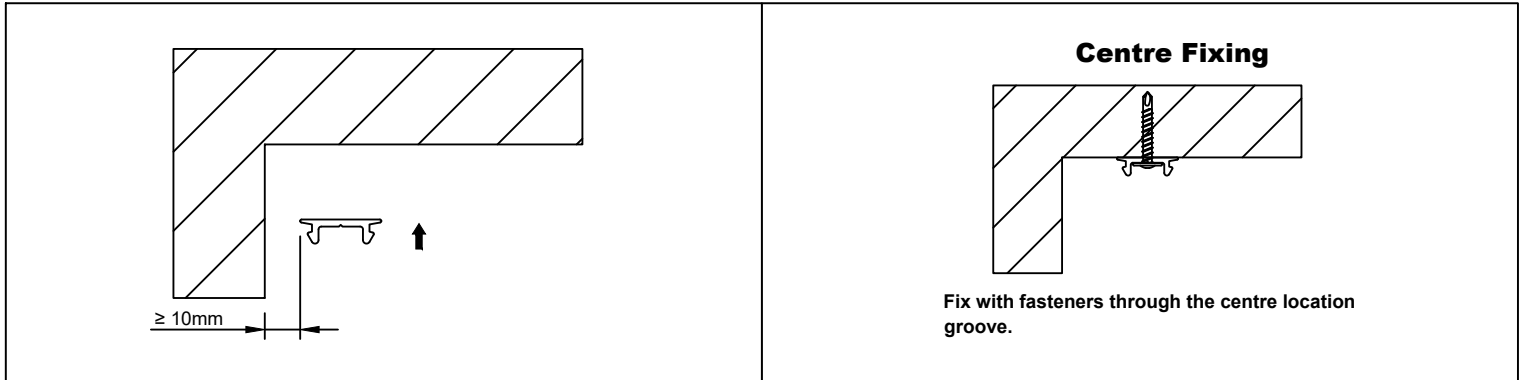

STEP 2 - Install additional Two-Piece Bases and Fix as Required

To ensure equal consistent spacing between each batten, space the bases according to your desired finished spacing using the below formula.

1. X (spacing between bases) = Desired finished spacing + 4mm
2. Y (centre to centre spacing) = Desired finished spacing + 25mm

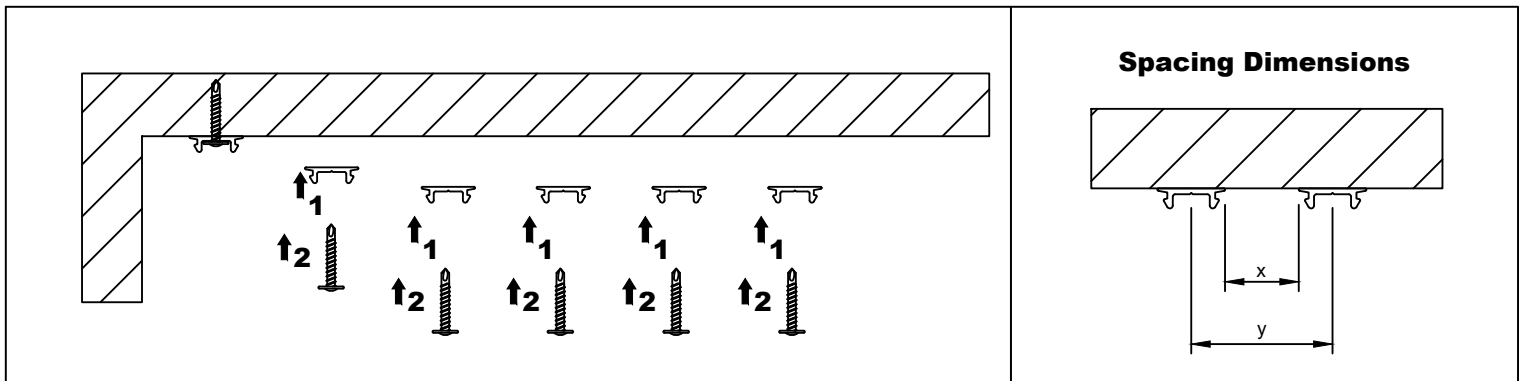

STEP 3 - Install Two-Piece Batten Covers and Fix as Required

Click the cover over each of the bases, ensuring a tight fit. Even though the DecoBatten product has been designed to ensure a secure click fit, if extra security against dislodgement is required, follow the detail provided below.

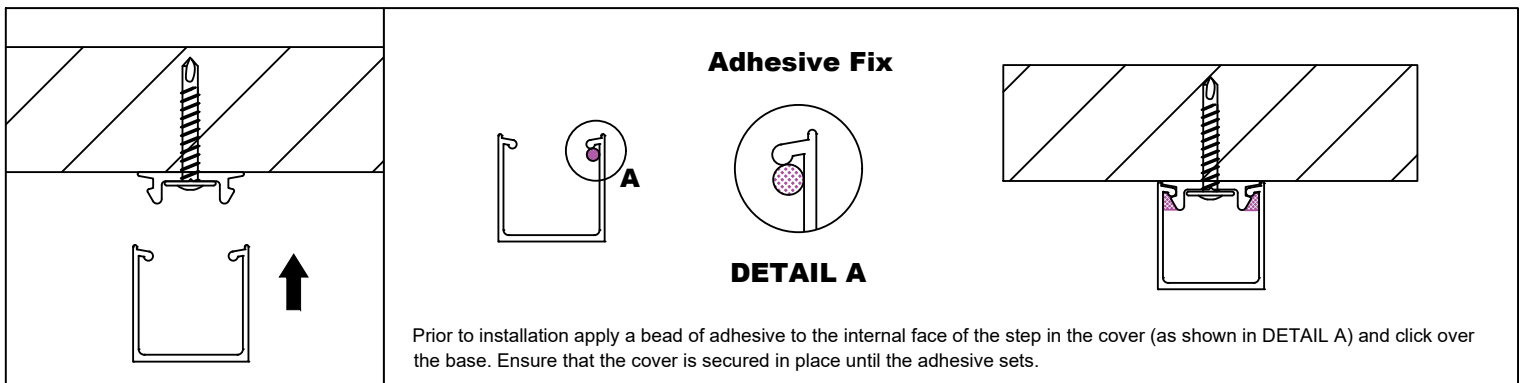

Preparation

Installation Surface

When installing SpaceBase, care should be taken to ensure the installation surface has been prepared adequately to ensure that it is fit for the intended purpose. The surface should also be clean and flat, before the installation of SpaceBase.

Supporting Structure and Fixings

Before installing SpaceBase/DecoBatten products, the supporting structure should be assessed to ensure that it is structurally sound and able to support live and dead loads of the SpaceBase/DecoBatten products that are to be installed. When fixing the SpaceBase, it is recommended that the bases are fixed at minimum 600mm centres when applied to a solid backing or 450mm centres when applied to framing. DECO recommends that users contact a certified Engineer to assess the supporting structure and fixings required when installing SpaceBase/DecoBatten, especially in high-wind and high-risk areas.

Processing of SpaceBase

WARNING - When processing SpaceBase, care should be taken and appropriate Personal Protective Equipment should be worn at all times. Failure to do so risks potential serious injury, disablement or death. When processing SpaceBase, care should be taken to ensure that the work space is clean and free from dust, sawdust, metal fines and/or shavings. Processing of the SpaceBase in areas with excessive dust, sawdust, metal fines and/or shavings risks potential damage to the finished surface.

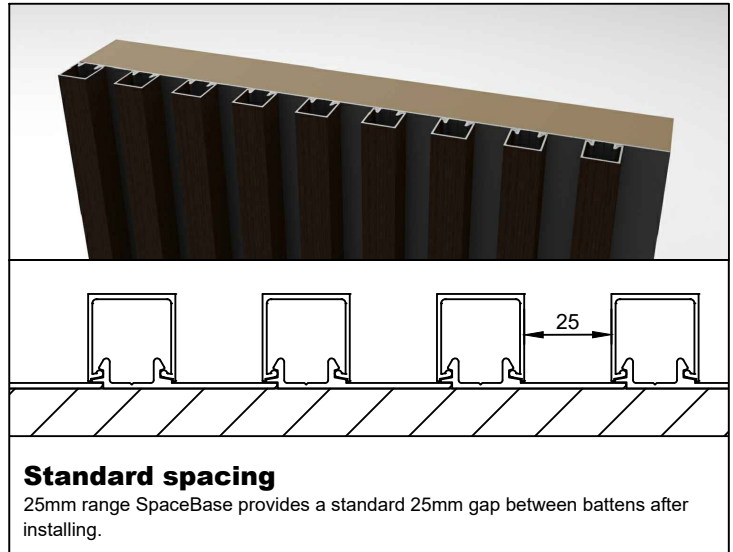

STEP 1 - Apply the SpaceBase to the Supporting Structure and Fix as Required

If the batten is to be installed flush to an end surface, ensure at least 10mm of clearance are provided to allow the batten cover to click over the base. To ensure a straight, consistent and parallel installation, it is strongly recommended that a level is used to position each base.

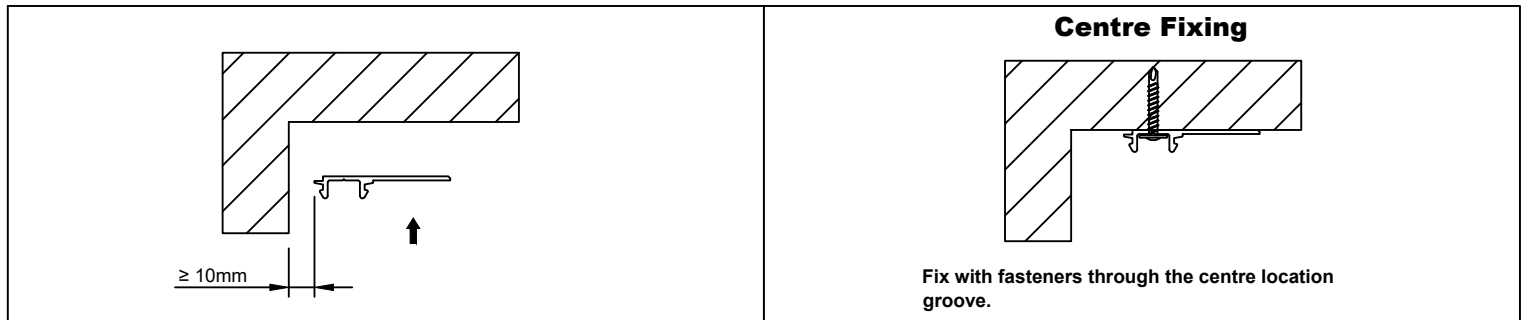

STEP 2 - Install additional SpaceBases and Fix as Required

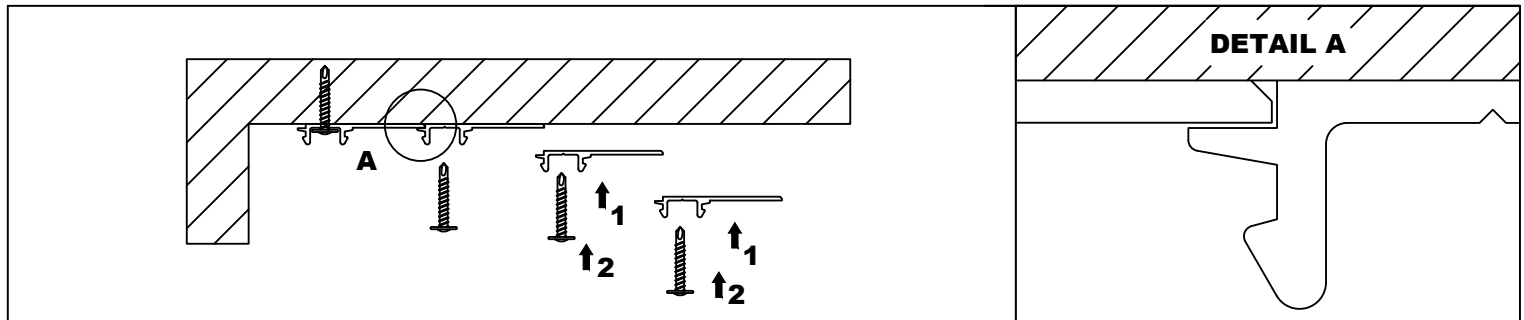

STEP 3 - Install Two-Piece Batten Covers and Fix as Required

Click the cover over each of the SpaceBases, ensuring a tight fit. Even though the DecoBatten product has been designed to ensure a secure click fit, if extra security against dislodgement is required, follow the detail provided below.

