

Jakob[®] INOX LINE

N₂

Swiss
Quality 

SINCE 1904



© **Copyright by**

Jakob AG, Drahtseilfabrik
CH-3555 Trubschachen
Switzerland 1988 / 2007

Technical data subject to change.

© **Copyright by**

Atelier Jakob AG/SA, Switzerland

Idea / Conception

Atelier Jakob AG/SA, Hannes Jakob SGD
CH-1783 Barberêche, Switzerland

Pliable, transparent grid structures made of stainless steel rope from the Jakob® INOX LINE series are **multifunctional and durable**: mounted on railings or in staircases, they provide **support and guidance**; on façades, they can be used as **training systems** for plants; in large rooms, they will create subtle accents as filigreed partitions. The Jakob® INOX LINE **Webnet** was subjected to numerous tests and complies with all applicable standards: As a permanent **protective and safety net** for bridges or observation platforms, it is absolutely UV- and weather-resistant, unlike conventional knotted plastic fiber nets.

The Jakob® INOX LINE **Webnet** has the skin-like characteristics of a diaphragm. It can form a plane surface but can also be tensioned into three-dimensional forms featuring funnel-type, cylindrical, or spherical shapes.

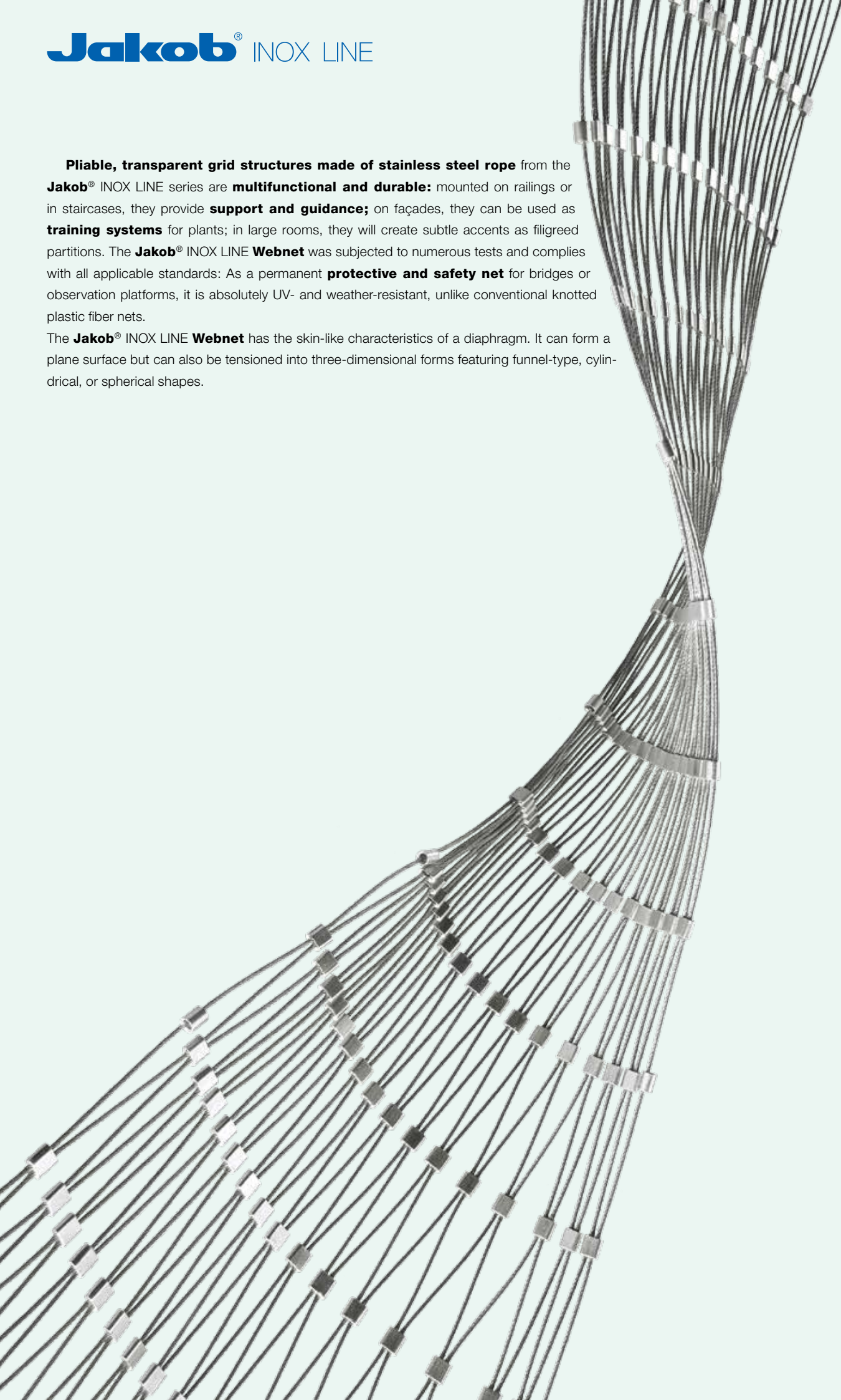



Webnet: Intelligent solutions in architecture and design

The Jakob® INOX LINE Webnet is a custom-manufactured, premium-quality product that is highly compatible with creative contemporary architecture. As part of our extensive, easy-to-assemble structural wire-rope series, it is ideal for flexible, intelligent solutions that address a vast variety of requirements: the multifunctional Jakob® INOX LINE Webnet technology combined with stainless steel rope, rods, or tubes with appropriate end connectors (Jakob® INOX LINE Basic 5.1 Green Solutions G1, and News X catalogues) not only discreetly fulfills its functions as a protective and supporting structure but also provides appeal as an elegant spatial design element.

Support and protection function

A lake region in western Switzerland with a safe bird's-eye view: in the **tethered balloon** on a platform **at the Lake of Neuenburg**, visitors can ascend to a height of 150 m. The large "captive balloon" was installed as a tourist attraction in the summer of 2002, when the Swiss National Exposition (Expo) took place. The combined **support and protection structure** made of rods, wire rope, and the **Jakob® INOX LINE Webnet** components created an impressive, futuristic takeoff and landing ramp with guaranteed safety factors.



10 29

Webnet

30

Suspension rope



30 31

Rope-end connectors



32

Suspension-rope clamps



32 33

Tube system



34

Connecting rod



34

Rod system



35

Rod holder



37

Assembly aids

Webnet C rail

37

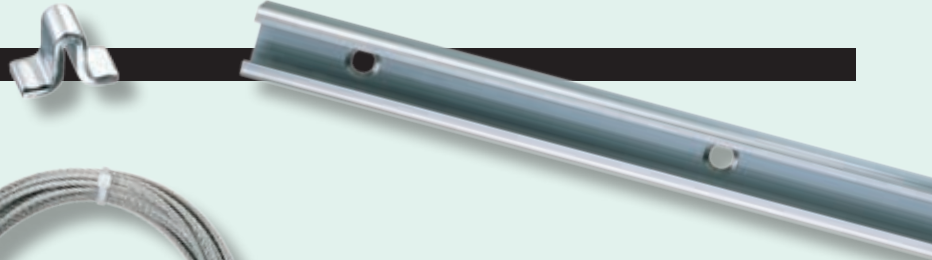

Webnet perimeter rope

38



Wire-rope cutters

38

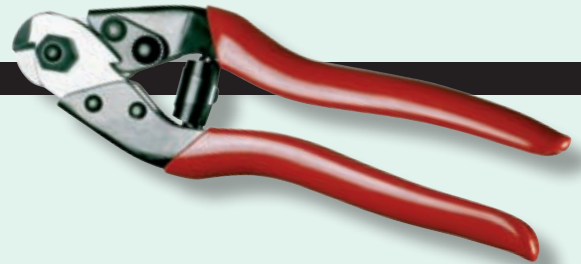

Webnet sleeves

38



Webnet eye ends

39



Swaging tools

38 39

Threaded fasteners

40



Accessories

41



Crossnet

80 81





8.1



8.3

Huarte (E)

Spatial net structure

- Webnet rope \varnothing 2.0 mm, mesh aperture 200 mm
- Webnet size total: 3100 m²



8.2



Playground Argenteuil, Paris (F)

Ball catcher

- Webnet rope \varnothing 1.5 mm, mesh aperture 60 mm
- Webnet size total: 120 m²

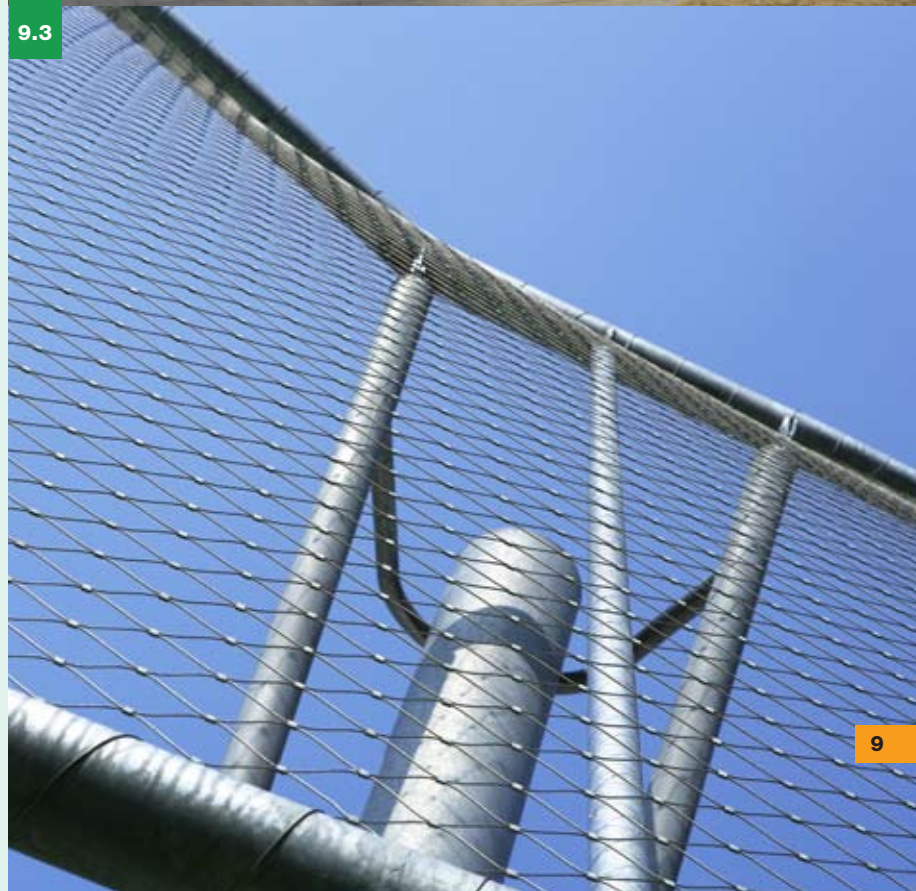

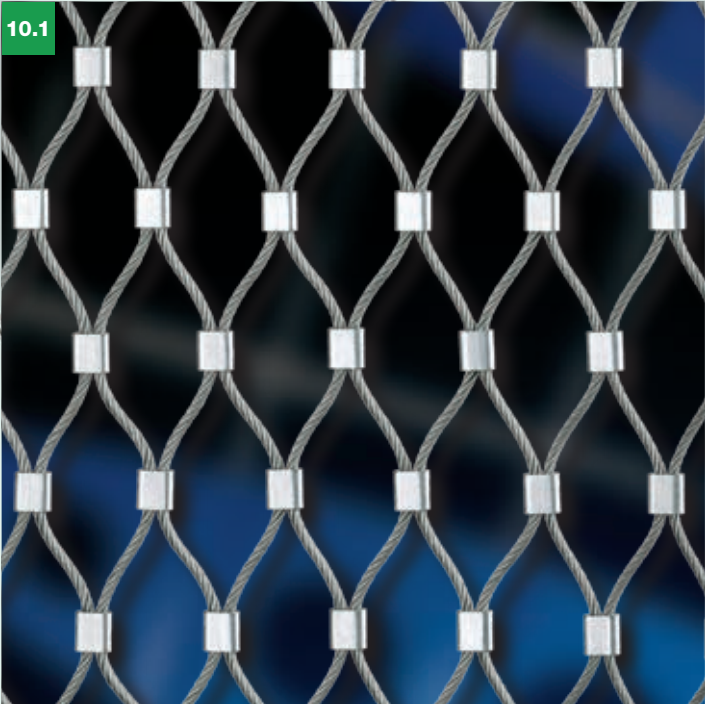

10.1

Webnet with mesh aperture **40 mm**
and **wire-rope diameter 3.0 mm**

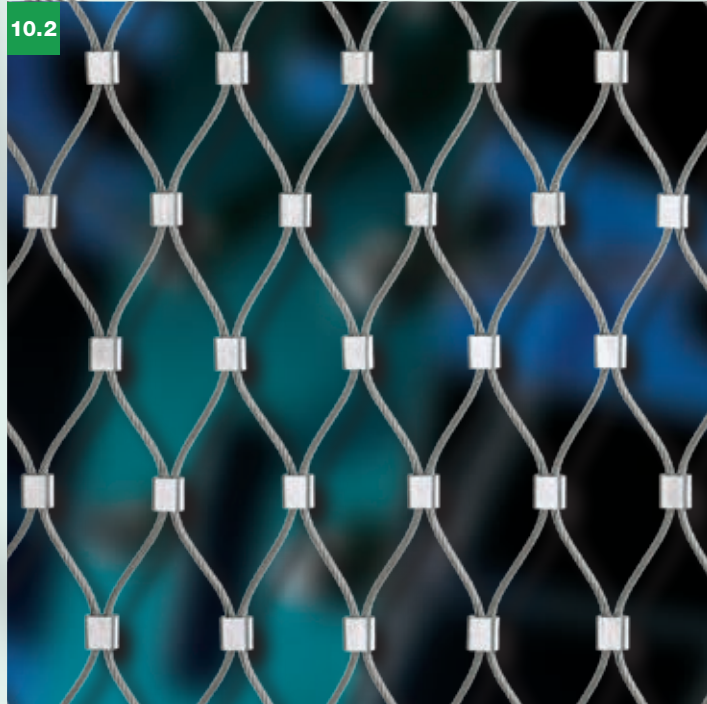

10.2

Webnet with mesh aperture **40 mm**
and **wire-rope diameter 2.0 mm**

A fabric of particular resilience and flexibility, a “net” whose strands are neither knotted nor crossed: the **Jakob[®] INOX LINE Webnet** is a construction based on stainless steel wire ropes that lie parallel in pairs connected and reciprocally curved by offset sleeves.

The net construction can be pulled apart like an accordion, producing a spring force that varies depending on the mesh aperture and wire-rope thickness.

The **Jakob[®] INOX LINE Webnet** is a vibrant, premium-quality product: the **mesh aperture** (variable, from very tight to very wide) and the **wire-rope diameter** (1.0 mm, 1.5 mm, 2.0 mm, and 3.0 mm) determine its functionality and aesthetics. Most **Jakob[®] INOX LINE** components are made from the AISI 316 material group.

11.1

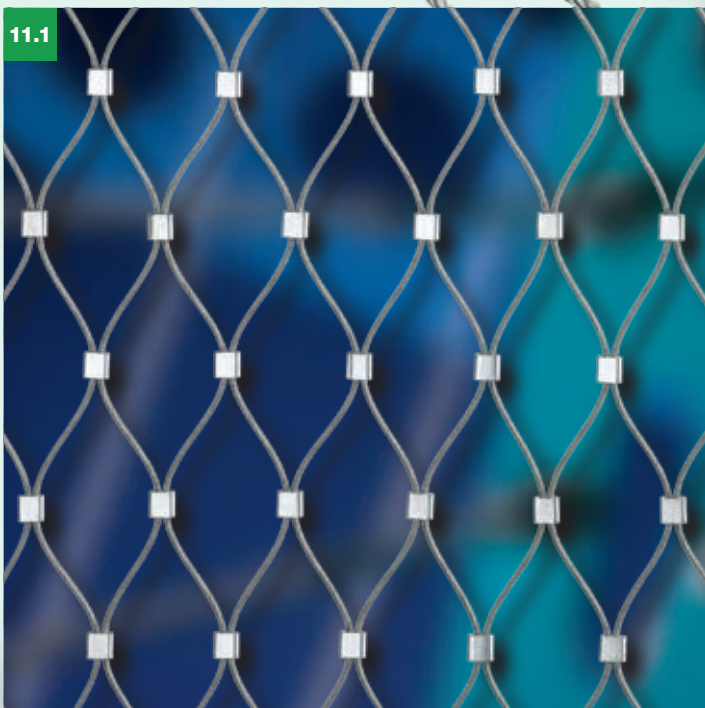

Webnet with mesh aperture 40 mm and wire rope-diameter 1.5 mm

11.2

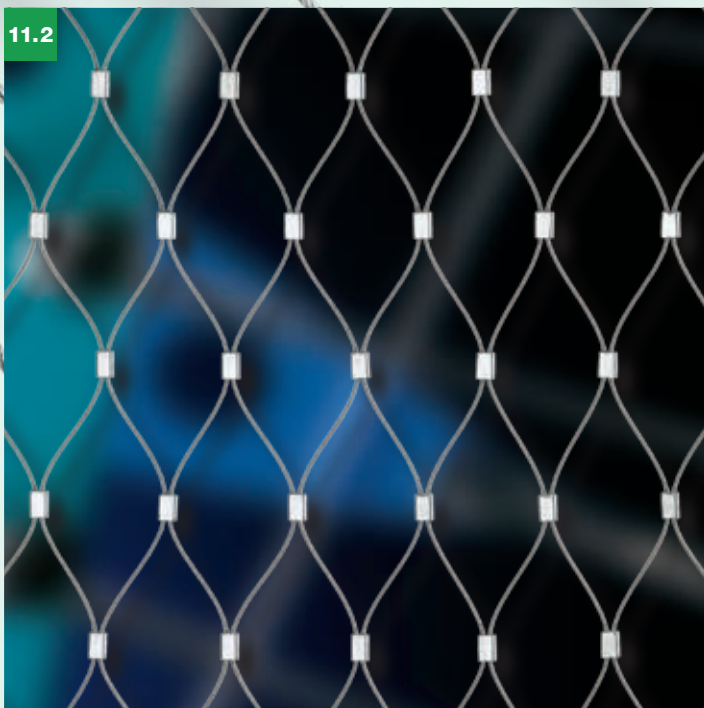

Webnet with mesh aperture 40 mm and wire rope-diameter 1.0 mm

12.1

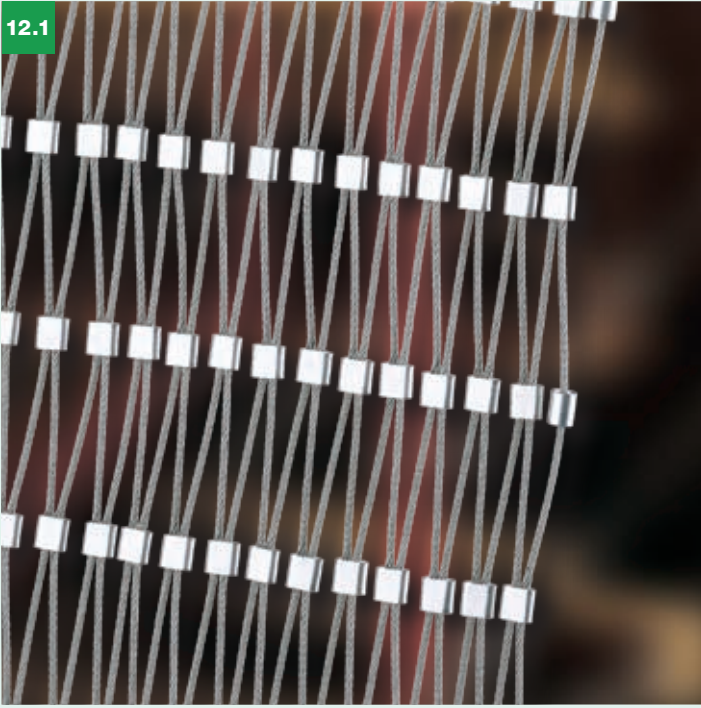

Webnet not tensioned (closed)

12.2

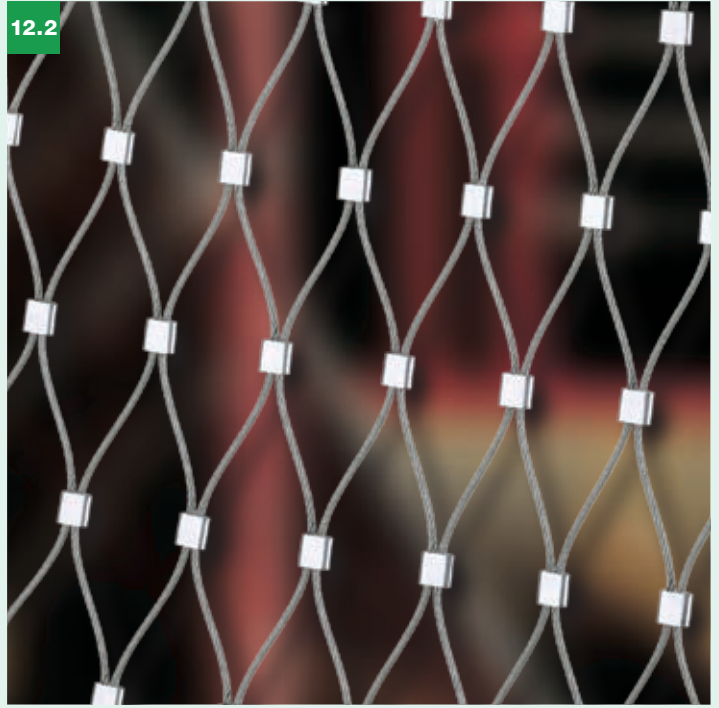

Webnet with 35° mesh angle

12.3



Webnet test frame for the determination of the force/elongation diagrams

The frame is used to determine the elongation of the **Webnet** in the height (**H**) and width (**W**) directions when exposed to different stretching forces. The insights form the basis of dimensioning and configuring the **Webnet** and the periphery structure.

12



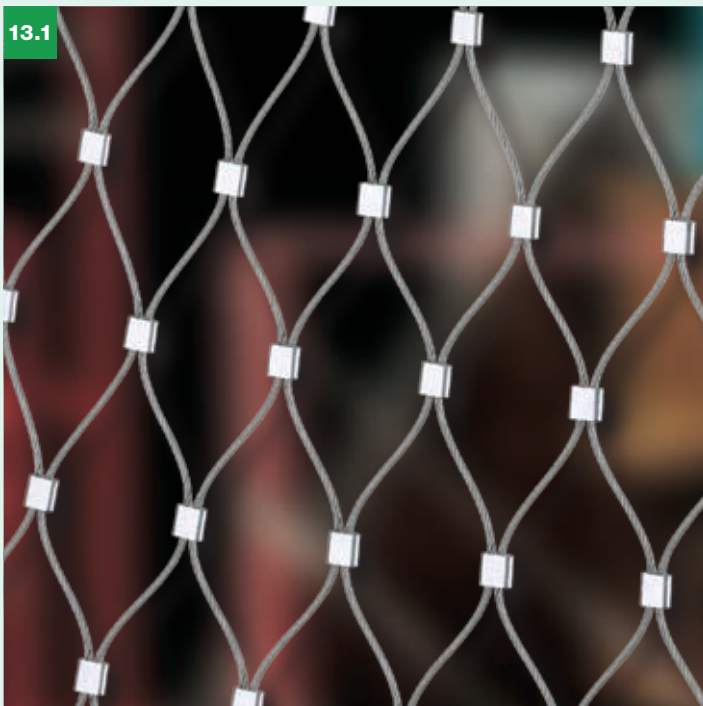

Webnet with 50° mesh angle

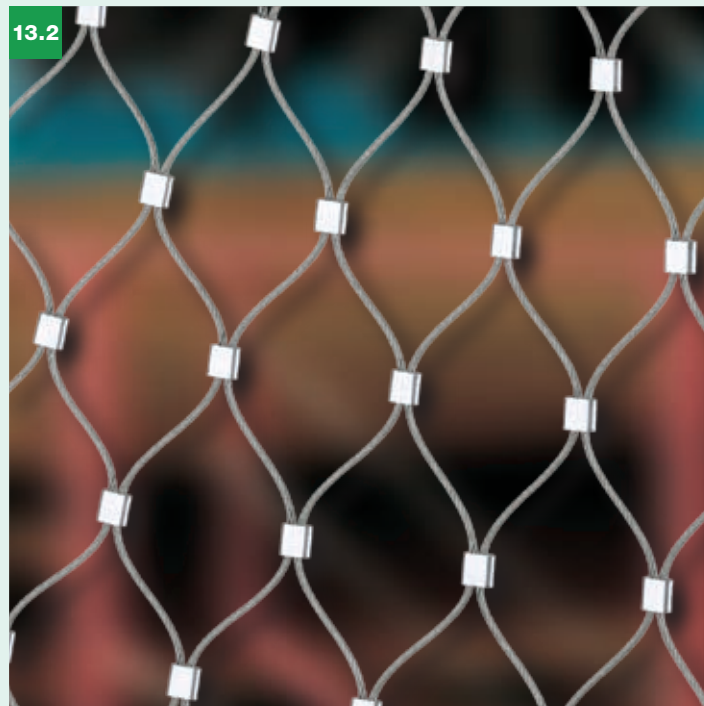

Webnet with 60° mesh angle (**Jakob®** standard)

The Jakob® INOX LINE Webnet was tested pursuant to EN 1263-1 for its static and dynamic load-bearing capacity.

Test data:

- **Webnet** size: length 7 m × width 5 m
- **Webnet** rope Ø 3.0 mm, mesh aperture 60 and 100 mm (horizontal and vertical meshes)
- **Webnet** rope Ø 2.0 mm, mesh aperture 60 and 100 mm (horizontal and vertical meshes)
- Ssuspension rope Ø 10.0 mm
- test object: 500-mm steel sphere, mass 100 kg
- drop height of test object: 7 m



Webnet with extended mesh angle: when stretched, the wire ropes load the sleeve (breaking limit).



14.1



14.2

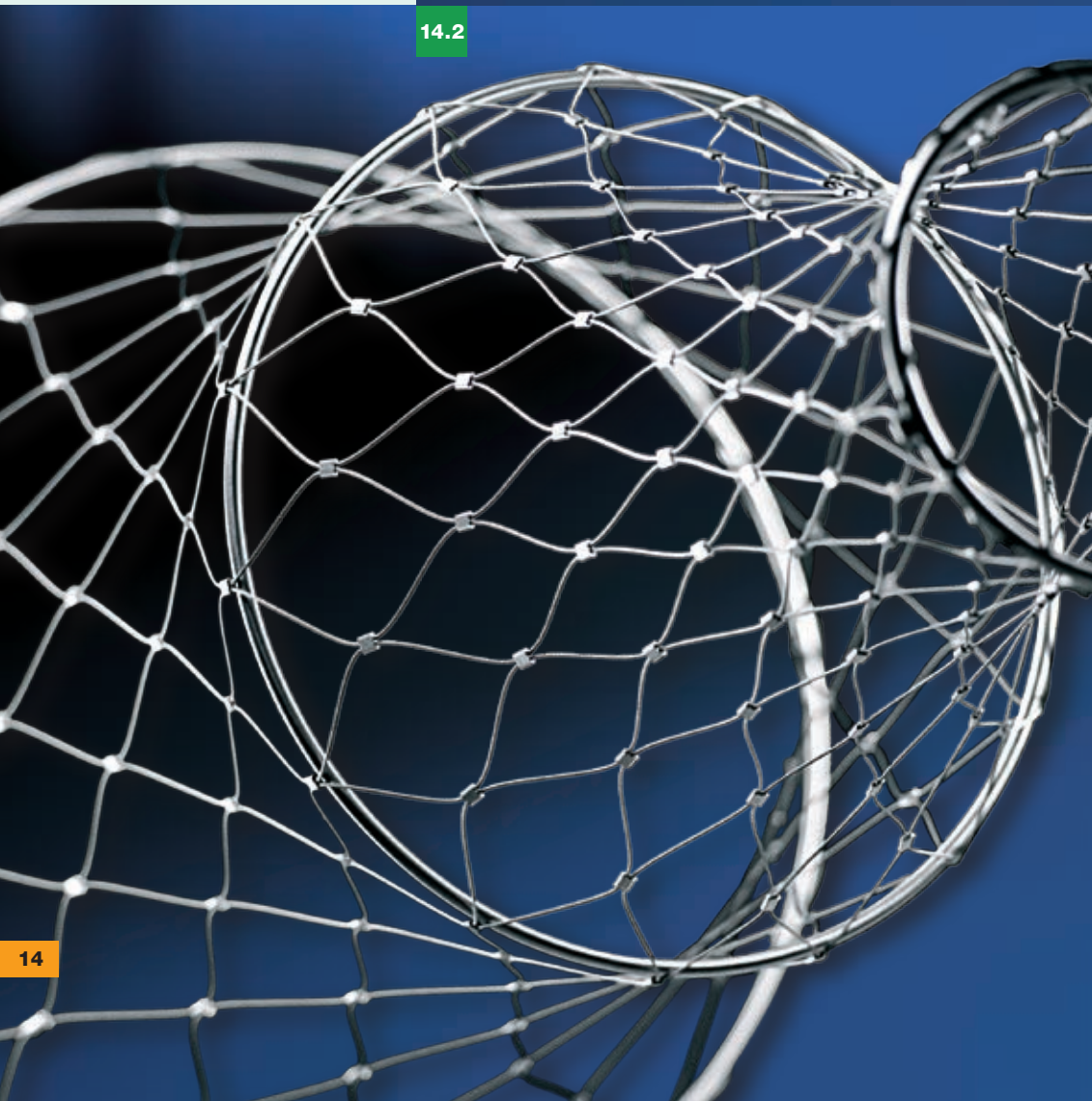

14.3

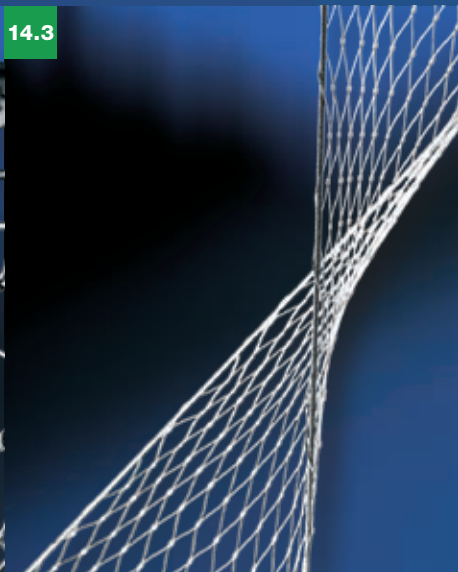

14.4



The **Jakob® INOX LINE Webnet** has the skin-like characteristics of a diaphragm. It can form a plane surface but can also be tensioned into three-dimensional forms featuring funnel-type, cylindrical, or spherical shapes.

Jakob® INOX LINE, the original:

- custom-manufactured
- filigreed, discreet, elegant, flexible
- multifunctional, compatible with creative architecture
- premium quality, rugged, weather-resistant, non-corroding

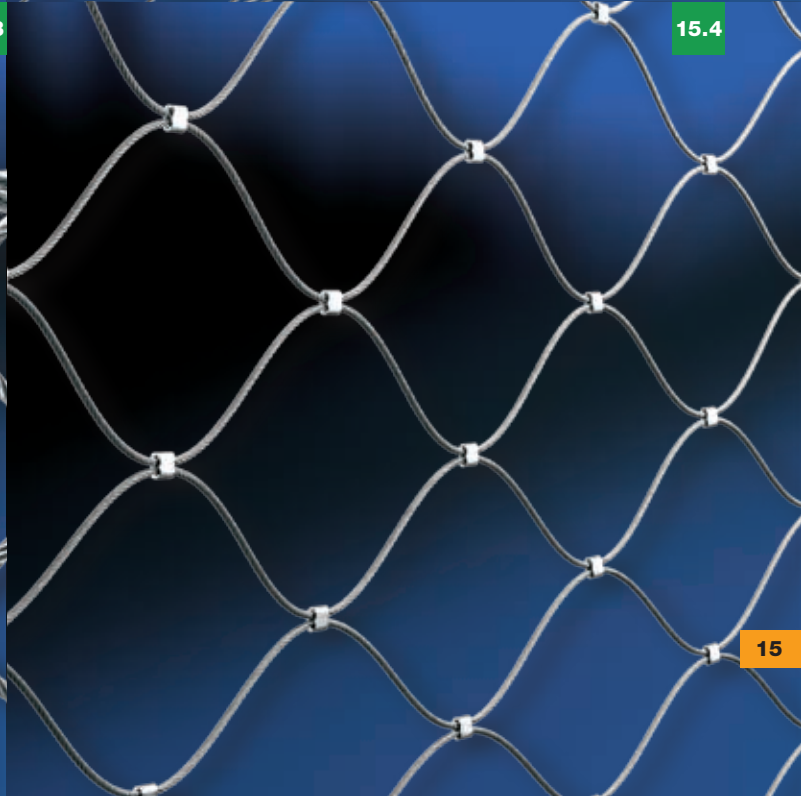
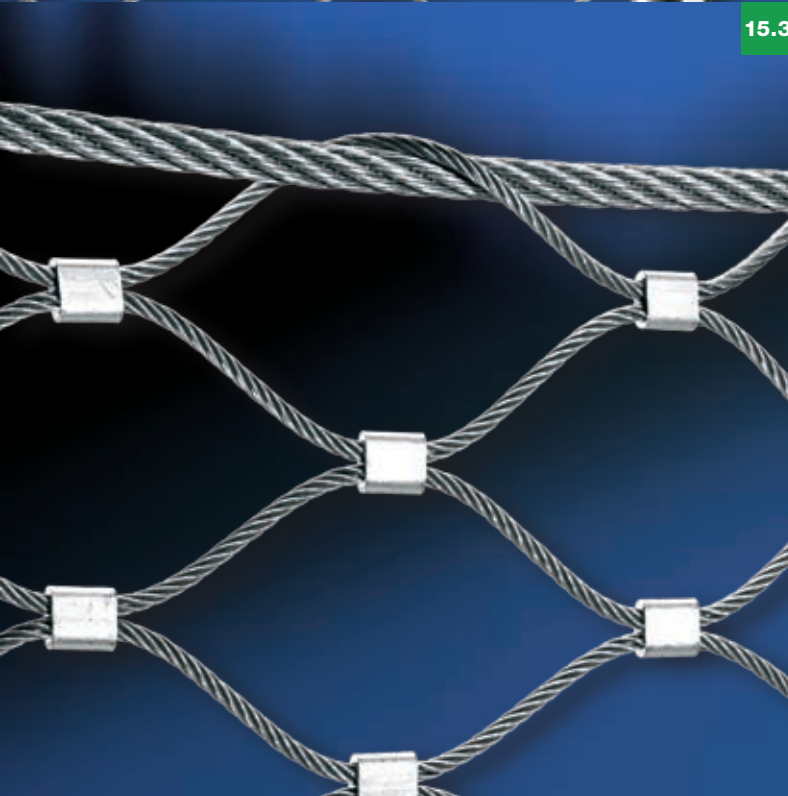
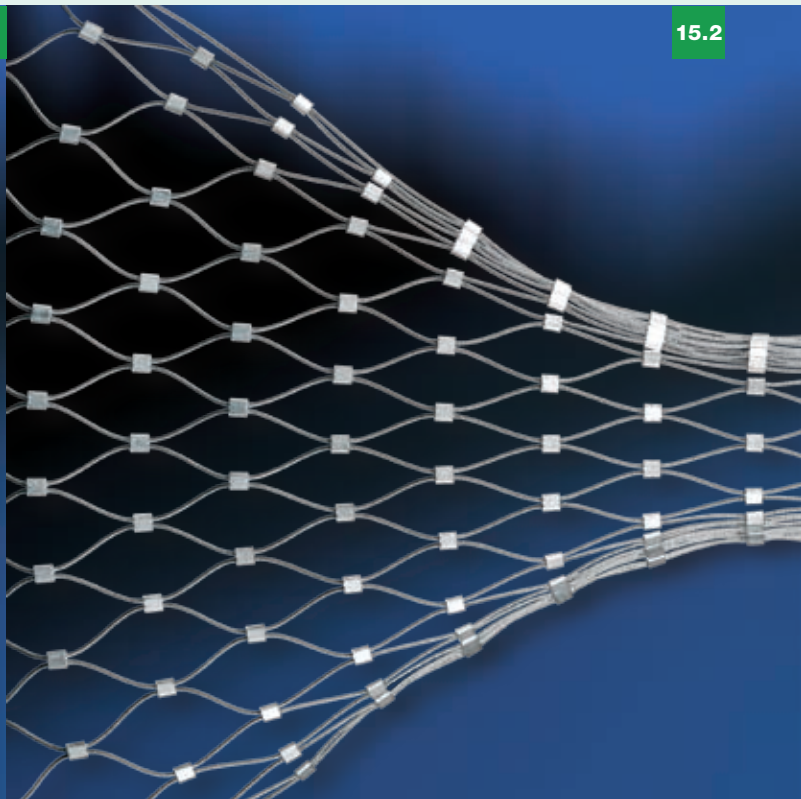



16.2

16.3

16.4

16.5

16.1



The multifunctional structural rope system composed of **Jakob® INOX LINE Webnet / Basic 5.1 / Green Solutions G1 / News X** components – stainless steel rope, rods, or tubes with appropriate end connectors – **opens new dimensions** and is fully designed for on-site assembly. However, we can also provide you with turnkey solutions including planning, engineering, installation blueprints, and assembly.

Jakob® INOX LINE, the original:

- custom-manufactured
- filigreed, discreet, elegant, flexible
- multifunctional, compatible with creative architecture
- premium quality, rugged, weather-resistant, non-corroding

Bern-Belpmoos airport (Switzerland)

- *Spherical Webnet shroud*
- *Webnet rope Ø 2.0 mm, mesh aperture 100 mm*



Unit conversion table

Length / Area / Mass

	in.	ft.	yd.	sq.in.	sq.ft.	sq.yd.	lb.
1.0 m	39.37	3.281	1.09				
1.0 m ²				1550.0	10.764	1.196	
1.0 kg							2.204
Meter Square meter Kilogram	1 Inch = 25.4 mm	1 foot = 304.8 mm	Yard	Square inch	Square foot	Square yard	Pound

Material groups

Table of major alloys

Group	Country standard			Typical composition				Type	Old designation	
	EN 10088-3	AISI	AFNOR	C max.	Cr	Ni	Div.			
AISI 301-304 group	1.4301	X5CrNi18-10	304	Z6CN18-09	0.07	18	9		Austenite	V2A
	1.4305	X8CrNiS18-9	303	Z10CNF18-09	0.15	18	8	S	Austenite	V2A
	1.4310	X10CrNi18-8	301	Z12CN17-08	0.12	17	7		Austenite	V2A
AISI 316 group	1.4401	X5CrNiMo17-12-2	316	Z6CND17-11	0.07	18	10		Austenite	V4A
	1.4404	X2CrNiMo17-12-2	316L	Z3CND17-11-02	0.03	17	11	Mo	Austenite	V4A
	1.4408	GX5CrNiMo19-11-2			0.07	19	10		Austenite	V4A
	1.4435	X2CrNiMo18-14-3	316L	Z3CND18-14-03	0.03	18	12		Austenite	V4A
	1.4436	X3CrNiMo17-13-3	316	Z6CND17-12	0.07	18	12		Austenite	V4A
	1.4571	X6CrNiMoTi17-12-2	316Ti	Z8CNDT17-12	0.10	18	10	Ti	Austenite	V4A
Designation of Webnet components	European standard	US standard	French standard	Carbon	Chromium	Nickel	S = Sulfur Ti = Titanium Mo = Molybdenum			

V2A
Easily machinable, corrosion-resistant
V4A
Acid-proof to high strength



The characteristics of the ambient atmosphere determine the selection of the most suitable materials.

A distinction is made between rural, urban, industrial, and maritime climates.

The urban and industrial atmospheres typically contain aggressive substances in the form of carbon-containing particles and sulfur dioxide (SO₂).

Chloride ion-containing aerosols are found in maritime climates.

The rural atmosphere is comparatively benign.

Most Jakob® INOX LINE components are made from the AISI 316 material group.

Webnet order

Notes for convenient ordering

Ordering example:

- ❶ Free clearance: **H** mm x **L** mm
- ❷ **Webnet type: A - H18 - Ø 1,5 - W 60 x H 106**
Order No. 20255-0150-060 (tin-plated copper sleeves)
Order No. 20256-0150-060 (stainless steel sleeves)
 (see table on page 21)
- ❸ Webnet perimeter rope on page 38
Part No. 10820-0150

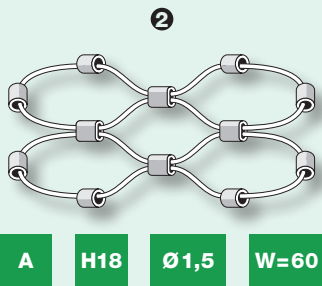
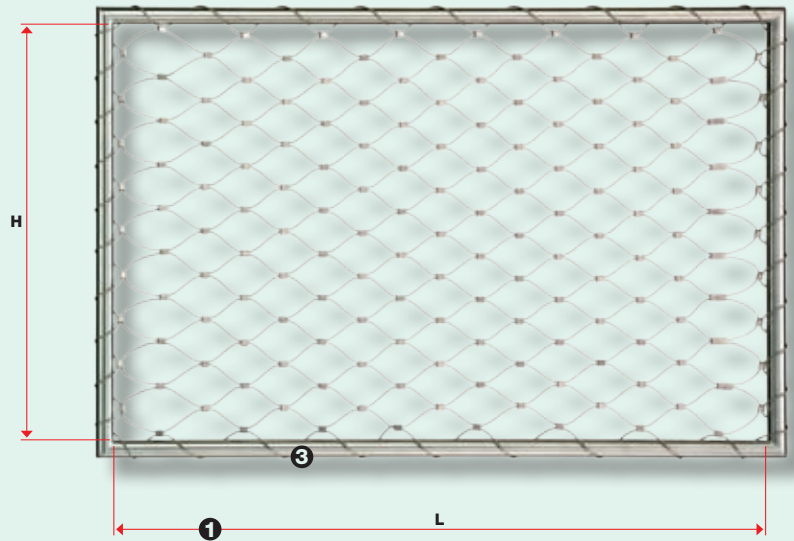
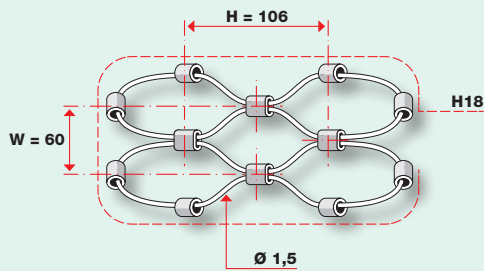

A The **Webnet** is available with wire rope and stranded wire. Types **A** or **B** are described on page 20.

H18 The **Webnet** is manufactured with vertical (**V**) or horizontal (**H**) meshes. Different perimeter design configurations are needed depending on the periphery structure (**V1-V30** on page 26 and **H1-H30** on page 28).

Ø 1,5 The **Webnet** is manufactured with four wire-rope and stranded-wire diameters (see tables on page 21). **Webnet** technical data: see tables on pages 22 to 23.

W x H The **Webnet** is manufactured with different mesh apertures (**W x H**) (see tables on page 21).



The Jakob® INOX LINE Webnet is ideal for filigreed security structures:

- public safety measures
- protection against rockfall along hiking trails
- road barriers and protection in pedestrian zones
- safety net on bridges
- protection on panorama terraces or observation platforms
- protection against thrown objects
- protection in sports stadiums
- retention of floating debris in harbors, rivers, and lakes

Webnet types

**The Jakob® INOX LINE Webnet,
made of stainless steel
rope 6 × 7 + WC and 6 × 19 + WC,**

is a multifunctional product for all types of protective applications where aesthetic appearance is also a must.

**The Jakob® INOX LINE Webnet,
made of stainless steel
stranded wire 1 × 19,**

is suitable for applications involving high shear/scour forces and/or high tensile forces within the rope structure.

A

The **Jakob® INOX LINE Webnet A**, made of stainless steel rope 6 × 7 + WC and 6 × 19 + WC (AISI 316 material group).



Rope 6 × 7 + WC
for Webnet rope Ø
1.0 mm, 1.5 mm, and 2.0 mm

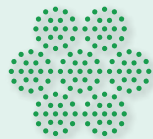

Rope 6 × 19 + WC
for Webnet rope Ø
3.0 mm

B

The **Jakob® INOX LINE Webnet B**, made of stainless steel stranded wire 1 × 19 (AISI 316 material group).

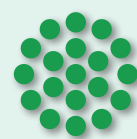

Stranded wire 1 × 19
for Webnet stranded wire Ø
1.0 mm, 1.5 mm, 2.0 mm, and 3.0 mm

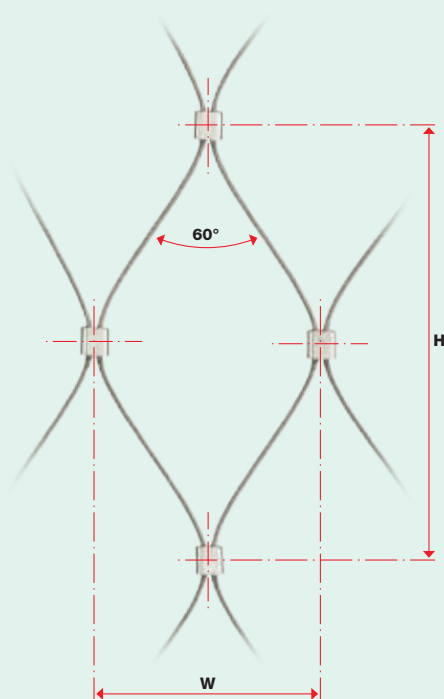

60° = standard mesh angle
W = mesh aperture
H = mesh aperture height

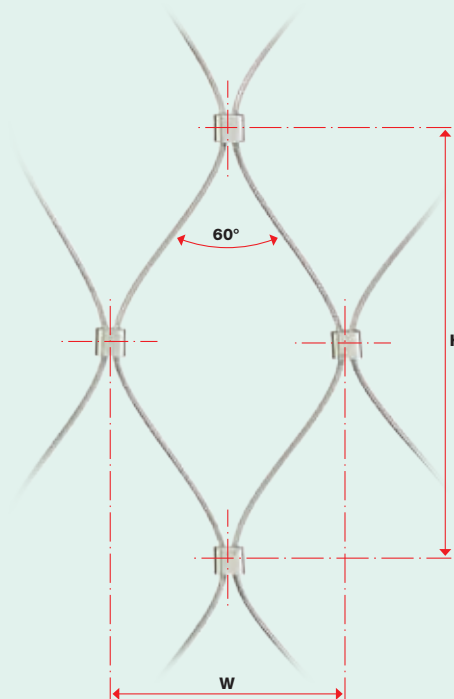

60° = standard mesh angle
W = mesh aperture
H = mesh aperture height

A

Sleeve material

The closed sleeve is threaded onto the wire ropes and swaged. The sleeve looks the same on both sides.

Order No. 20255-
Sleeve: DIN E-CU sn (tin-plated copper)
Order No. 20256-
Sleeve: AISI 316 material group

B

Sleeve material

The closed sleeve is threaded onto the stranded wire and swaged. The sleeve looks the same on both sides.

Order No. 20255-
Sleeve: DIN E-CU sn (tin-plated copper)
Order No. 20256-
Sleeve: AISI 316 material group

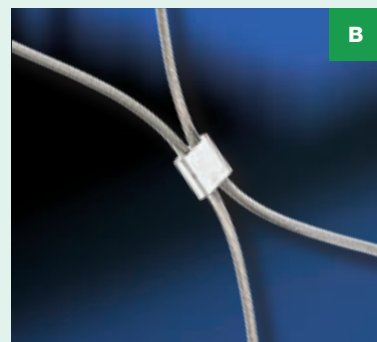
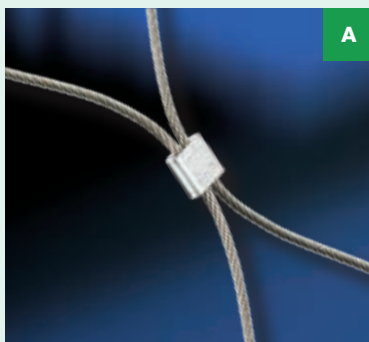
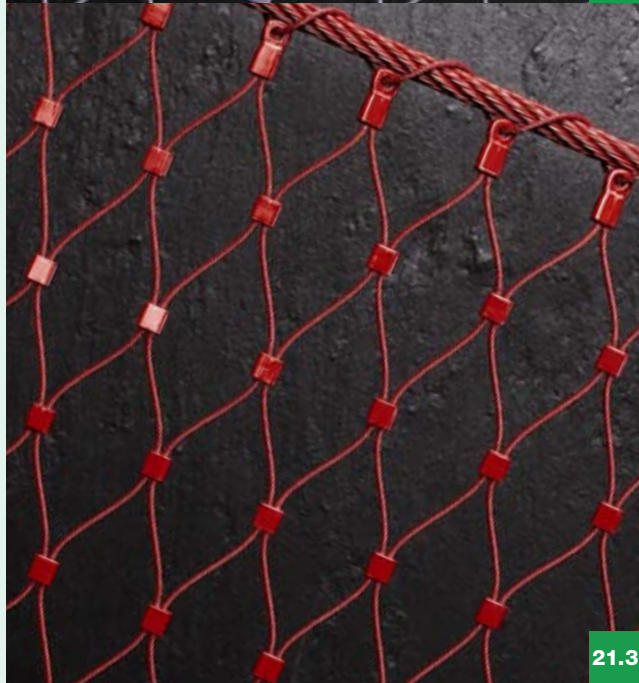

Tin-plated copper sleeve: Nr. 20255- Sleeve AISI 316: Nr. 20256-	Rope \varnothing mm	Mesh aperture W x H mm
0100-020	1,0	20 x 38,2
0100-030	1,0	30 x 53
0100-040	1,0	40 x 70,5
0100-050	1,0	50 x 87,2
0100-060	1,0	60 x 105
0100-070	1,0	70 x 122
0100-080	1,0	80 x 139
0150-025	1,5	25 x 55,9
0150-030	1,5	30 x 61,6
0150-040	1,5	40 x 75
0150-050	1,5	50 x 90
0150-060	1,5	60 x 106
0150-070	1,5	70 x 124,2
0150-080	1,5	80 x 141
0150-100	1,5	100 x 175
0150-120	1,5	120 x 209
0150-140	1,5	140 x 244
0150-160	1,5	160 x 279
0150-180	1,5	180 x 313
0200-040	2,0	40 x 75,1
0200-050	2,0	50 x 90,5
0200-060	2,0	60 x 106
0200-070	2,0	70 x 124
0200-080	2,0	80 x 141
0200-100	2,0	100 x 175
0200-120	2,0	120 x 209
0200-140	2,0	140 x 244
0200-160	2,0	160 x 279
0200-180	2,0	180 x 313
0300-040	3,0	40 x 74,8
0300-050	3,0	50 x 90,5
0300-060	3,0	60 x 106
0300-070	3,0	70 x 124
0300-080	3,0	80 x 141
0300-100	3,0	100 x 175
0300-120	3,0	120 x 209
0300-140	3,0	140 x 244
0300-160	3,0	160 x 279
0300-180	3,0	180 x 313

Tin-plated copper sleeve: Nr. 20255- Sleeve AISI 316: Nr. 20256-	Stranded wire \varnothing mm	Mesh aperture W x H mm
0100-041	1,0	40 x 70,5
0100-051	1,0	50 x 87,2
0100-061	1,0	60 x 105
0100-071	1,0	70 x 122
0100-081	1,0	80 x 139
0150-041	1,5	40 x 75
0150-051	1,5	50 x 90
0150-061	1,5	60 x 106
0150-071	1,5	70 x 124,2
0150-081	1,5	80 x 141
0150-101	1,5	100 x 175
0150-121	1,5	120 x 209
0150-141	1,5	140 x 244
0150-161	1,5	160 x 279
0150-181	1,5	180 x 313
0200-061	2,0	60 x 106
0200-071	2,0	70 x 124
0200-081	2,0	80 x 141
0200-101	2,0	100 x 175
0200-121	2,0	120 x 209
0200-141	2,0	140 x 244
0200-161	2,0	160 x 279
0200-181	2,0	180 x 313
0300-071	3,0	70 x 124
0300-081	3,0	80 x 141
0300-101	3,0	100 x 175
0300-121	3,0	120 x 209
0300-141	3,0	140 x 244
0300-161	3,0	160 x 279
0300-181	3,0	180 x 313

The **Jakob® INOX LINE Webnet** is a vibrant, premium-quality product made from the stainless AISI 316 material group: the **mesh aperture W x H** (variable, from very tight to very wide), the **wire-rope diameter** (1.0 mm, 1.5 mm, 2.0 mm, and 3.0 mm), and the choice of **wire rope or stranded wire** determine functionality and aesthetics. On request, we will supply **Webnet** products in any RAL or NCS colors.

Technical data Webnet A and B



	A				B			
Ø mm	Rope Ø 1.0	Rope Ø 1.5	Rope Ø 2.0	Rope Ø 3.0	Strand Ø 1.0	Strand Ø 1.5	Strand Ø 2.0	Strand Ø 3.0
Construction	6 x 7 + WC	6 x 7 + WC	6 x 7 + WC	6 x 19 + WC	1 x 19	1 x 19	1 x 19	1 x 19
Minimum breaking load kN	0,5	1,4	2,4	4,6	0,8	1,8	3,3	7,4
Material group	AISI 316				AISI 316			
Sleeves:								
Swaged dimensions mm	4 x 5 x 2	7 x 7,5 x 3	10 x 9 x 3,8	11 x 11 x 4,2	4 x 5 x 2	7 x 7,5 x 3	10 x 9 x 3,8	11 x 11 x 4,2
Node strength L/kN	0,1	0,1	0,3	0,2	0,1	0,1	0,3	0,2
Node strength Q/kN	1,0	2,0	2,6	4,0	1,0	2,0	2,6	4,0
Material	E-CU sn or AISI 316				E-CU sn or AISI 316			
W 20, 60°								
Mesh aperture H mm	20							
Mesh aperture height H mm	38,2							
Weight kg/m ²	1,12							
Rope length m/m ²	104							
Number of sleeves/m ²	2676							
Light transmission %	85,6							
W 25, 60°								
Mesh aperture H mm	25	25						
Mesh aperture height H mm	46	55,9						
Weight kg/m ²	0,746	1,96						
Rope length m/m ²	87	87						
Number of sleeves/m ²	1800	1800						
Light transmission %	88,82	82,93						
W 30, 60°								
Mesh aperture H mm	30	30						
Mesh aperture height H mm	53	61,6						
Weight kg/m ²	0,666	1,848						
Rope length m/m ²	80	80						
Number of sleeves/m ²	1300	1300						
Light transmission %	90,73	88,84						
W 40, 60°								
Mesh aperture H mm	40	40	40	40	40	40		
Mesh aperture height H mm	70,5	75	75,1	74,8	70,5	75		
Weight kg/m ²	0,443	1,196	2,31	4,1	0,698	1,364		
Rope length m/m ²	60	60	60	60	60	60		
Number of sleeves/m ²	760	760	760	760	760	760		
Light transmission %	93,29	89,55	84,94	79,58	93,29	89,55		
W 50, 60°								
Mesh aperture H mm	50	50	50	50	50	50		
Mesh aperture height H mm	87,2	90	90,5	90,5	87,2	90		
Weight kg/m ²	0,324	0,853	1,660	2,91	0,500	0,987		
Rope length m/m ²	48	48	48	48	48	48		
Number of sleeves/m ²	490	490	490	490	490	490		
Light transmission %	94,72	91,76	88,4	84,09	94,72	91,76		
W 60, 60°								
Mesh aperture H mm	60	60	60	60	60	60	60	
Mesh aperture height H mm	105	106	106	106	105	106	106	
Weight kg/m ²	0,257	0,668	1,294	2,268	0,392	0,780	1,514	
Rope length m/m ²	40	40	40	40	40	40	40	
Number of sleeves/m ²	360	360	360	360	360	360	360	
Light transmission %	95,67	93,2	90,56	86,8	95,67	93,2	90,56	
W 70, 60°								
Mesh aperture H mm	70	70	70	70	70	70	70	70
Mesh aperture height H mm	122	124,2	124	124	122	124,2	124	124
Weight kg/m ²	0,207	0,528	1,014	1,812	0,310	0,622	1,202	2,155
Rope length m/m ²	34	34	34	34	34	34	34	34
Number of sleeves/m ²	260	260	260	260	260	260	260	260
Light transmission %	96,32	94,29	92,03	88,86	96,32	94,29	92,03	88,86



Ø mm	A				B			
	Rope Ø 1.0	Rope Ø 1.5	Rope Ø 2.0	Rope Ø 3.0	Strand Ø 1.0	Strand Ø 1.5	Strand Ø 2.0	Strand Ø 3.0
W 80, 60°								
Mesh aperture H mm	80	80	80	80	80	80	80	80
Mesh aperture height H mm	139	141	141	141	139	141	141	141
Weight kg/m ²	0,173	0,435	0,831	1,513	0,256	0,519	0,997	1,815
Rope length m/m ²	30	30	30	30	30	30	30	30
Number of sleeves/m ²	195	195	195	195	195	195	195	195
Light transmission %	96,83	95,05	93,12	90,34	96,83	95,05	93,12	90,34
W 100, 60°								
Mesh aperture H mm		100	100	100		100	100	100
Mesh aperture height H mm		175	175	175		175	175	175
Weight kg/m ²		0,334	0,633	1,180		0,404	0,771	1,431
Rope length m/m ²		25	25	25		25	25	25
Number of sleeves/m ²		130	130	130		130	130	130
Light transmission %		96,09	94,61	92,36		96,09	94,61	92,36
W 120, 60°								
Mesh aperture H mm		120	120	120		120	120	120
Mesh aperture height H mm		209	209	209		209	209	209
Weight kg/m ²		0,268	0,505	0,955		0,327	0,621	1,167
Rope length m/m ²		21	21	21		21	21	21
Number of sleeves/m ²		95	95	95		95	95	95
Light transmission %		96,77	95,56	93,68		96,77	95,56	93,68
W 140, 60°								
Mesh aperture H mm		140	140	140		140	140	140
Mesh aperture height H mm		244	244	244		244	244	244
Weight kg/m ²		0,222	0,417	0,798		0,272	0,517	0,980
Rope length m/m ²		18	18	18		18	18	18
Number of sleeves/m ²		73	73	73		73	73	73
Light transmission %		97,26	96,24	95,29		97,26	96,24	95,29
W 160, 60°								
Mesh aperture H mm		160	160	160		160	160	160
Mesh aperture height H mm		279	279	279		279	279	279
Weight kg/m ²		0,190	0,356	0,689		0,235	0,445	0,850
Rope length m/m ²		16	16	16		16	16	16
Number of sleeves/m ²		57	57	57		57	57	57
Light transmission %		97,62	96,74	95,32		97,62	96,74	95,32
W 180, 60°								
Mesh aperture H mm		180	180	180		180	180	180
Mesh aperture height H mm		313	313	313		313	313	313
Weight kg/m ²		0,162	0,303	0,591		0,202	0,380	0,732
Rope length m/m ²		14	14	14		14	14	14
Number of sleeves/m ²		45	45	45		45	45	45
Light transmission %		97,89	97,12	95,83		97,89	97,12	95,83

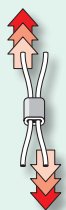

L
Longitudinal node strength

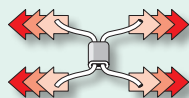

Q
Transversal node strength (breaking load of swage)

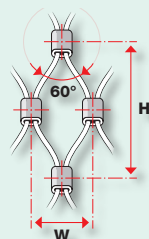

60°
Standard mesh angle
W
Mesh aperture
H
Mesh aperture height

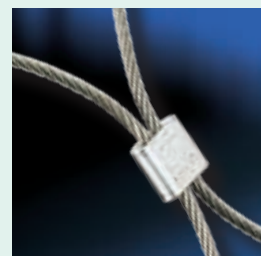

A
Sleeve with wire rope

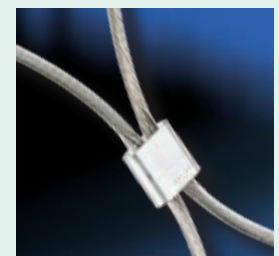

B
Sleeve with stranded wire

Webnet as a suspended ceiling in a gym and ancillary rooms of the sports facility. In the entrance area, the Webnet is used as a ball catcher and safety net. The nets are attached with non-corroding wire rope and rods with end connectors.



24.1



24.2



Gurmels gymnastics and sports hall (CH)

Safety and ball catcher nets

Suspended ceiling

- Webnet rope \varnothing 2.0 mm, mesh aperture 120 mm
- Webnet size total: 2600 m²

25.1



25.2

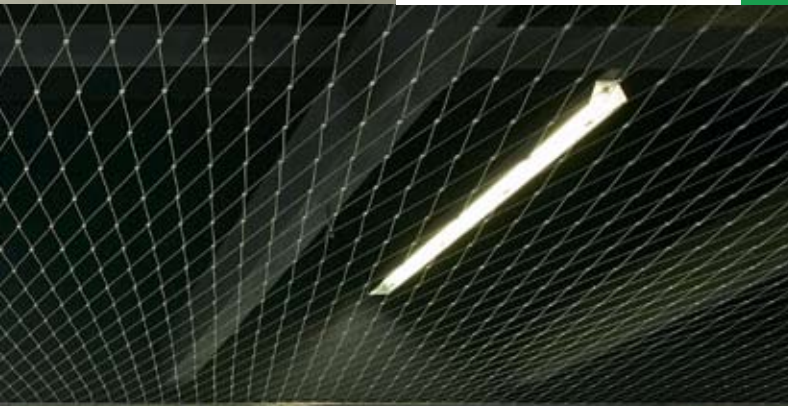

25.3



Possible perimeter types for Webnet, vertical mesh

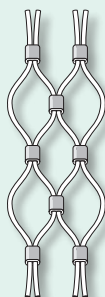

V1

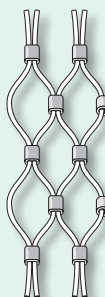

V2

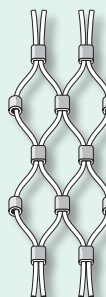

V3

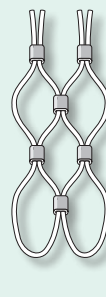

V4

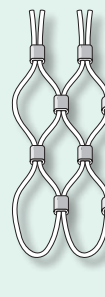

V5

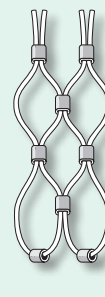

V6



V7



V8



V9

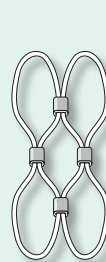

V10

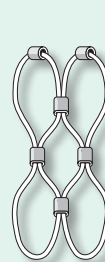

V11



V12

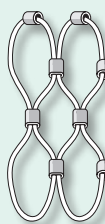

V13

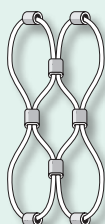

V14

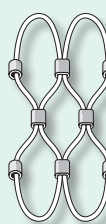

V15

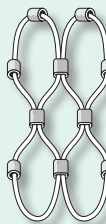

V16

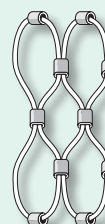

V17

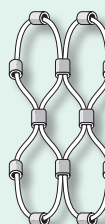

V18

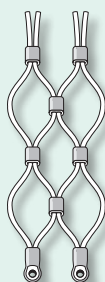

V19

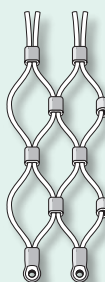

V20

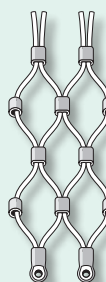

V21



V22



V23

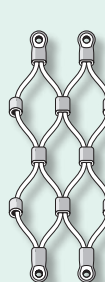

V24



V25



V26

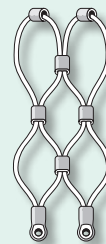

V27

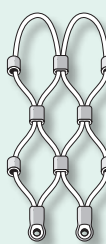

V28

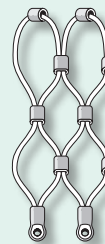

V29

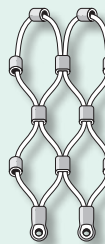

V30



Vertical mesh perimeter:
open at top with wire-rope end pairs

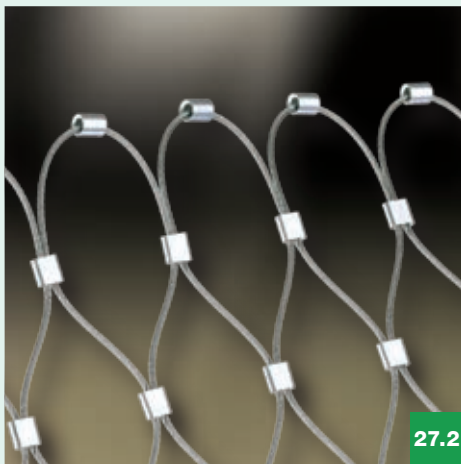

Vertical mesh perimeter:
closed with uncompressed sleeves at top



Webnet V: vertical mesh



27.4

Selection criteria for perimeter configuration V1 to V30

- Construction of periphery structure, such as suspension ropes (p. 30/31), tubular frame (p. 32/33), rod system (p. 34/35), or Webnet C rail (p. 37)
- Overall dimensions of Webnet
- Assembly-related reasons
- Magnitude of Webnet pretension forces

Some selection criteria for vertical (V) or horizontal (H) Webnet mesh orientation

- Architectural considerations
- Vertical meshes are less suitable for climbing (safety factor load)
- Assembly-related reasons (tight radii always require vertical meshes)
- When the Webnet is tensioned, the forces are greater in the mesh height direction than in the mesh width direction.



Vertical mesh perimeter:
with uncompressed sleeves at right

27.5

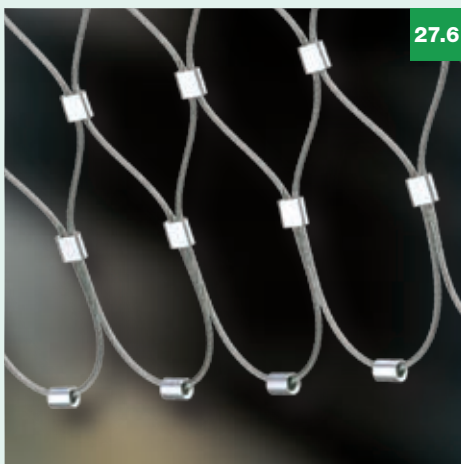

Vertical mesh perimeter:
closed with uncompressed sleeves at bottom

27.6

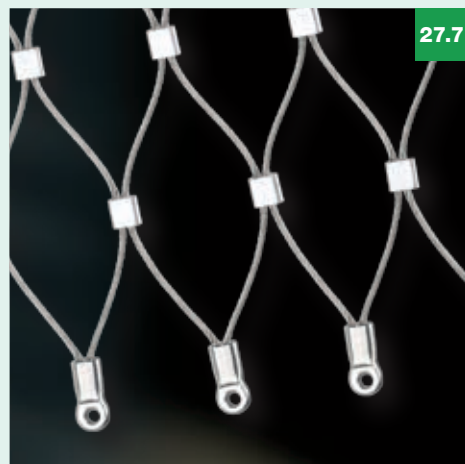

Vertical mesh perimeter:
closed with Webnet eye ends at bottom

27.7

Possible Webnet perimeter types, horizontal mesh

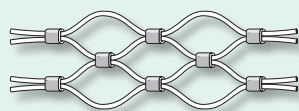

H1

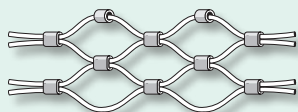

H2

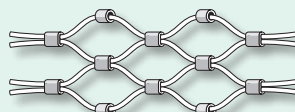

H3

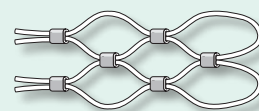

H4

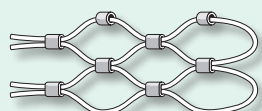

H5

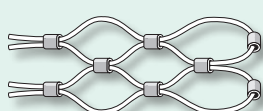

H6

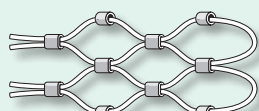

H7

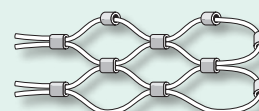

H8

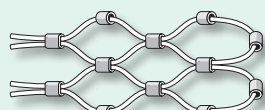

H9

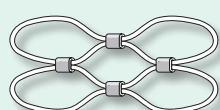

H10

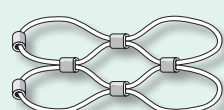

H11

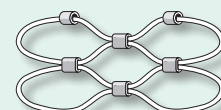

H12

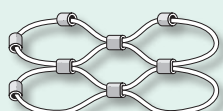

H13

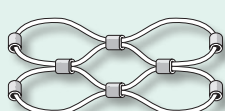

H14

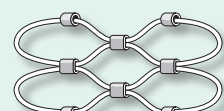

H15

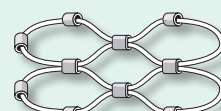

H16

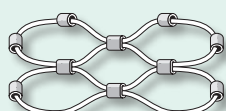

H17

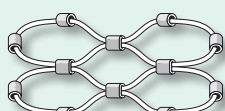

H18

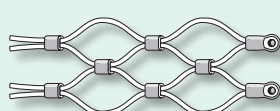

H19

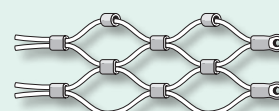

H20

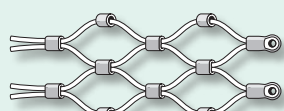

H21

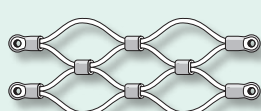

H22

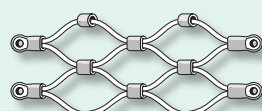

H23

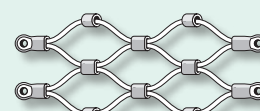

H24

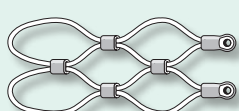

H25

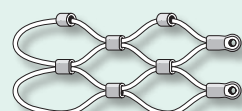

H26

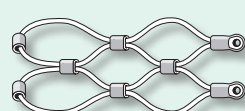

H27

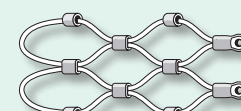

H28

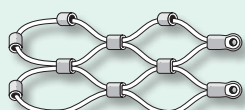

H29

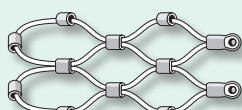

H30



29.1

Horizontal mesh perimeter:
closed with uncompressed sleeves at right



29.2

Horizontal mesh perimeter:
with uncompressed sleeves at bottom

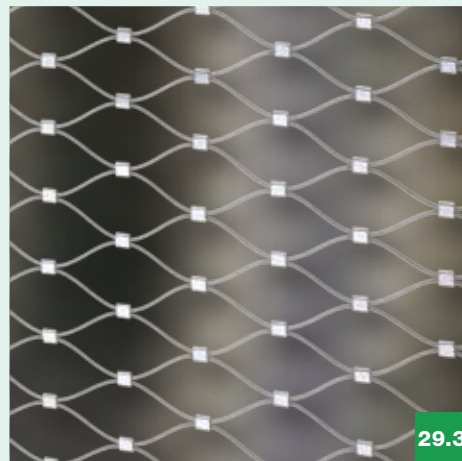

29.3

Webnet H: horizontal mesh



29.4

Selection criteria for perimeter configuration H1 to H30

- Construction of periphery structure, such as suspension ropes (p. 30/31), tubular frame (p. 32/33), rod system (p. 34/35), or Webnet C rail (p. 37)
- Overall dimensions of Webnet
- Assembly-related reasons
- Magnitude of Webnet pretension forces

Some selection criteria for vertical (V) or horizontal (H) Webnet mesh orientation

- Architectural considerations
- Vertical meshes are less suitable for climbing (safety factor load)
- Assembly-related reasons (tight radii always require vertical meshes)
- When the Webnet is tensioned, the forces are greater in the mesh height direction than in the mesh width direction.

Horizontal mesh perimeter:
open at left with wire-rope end pairs

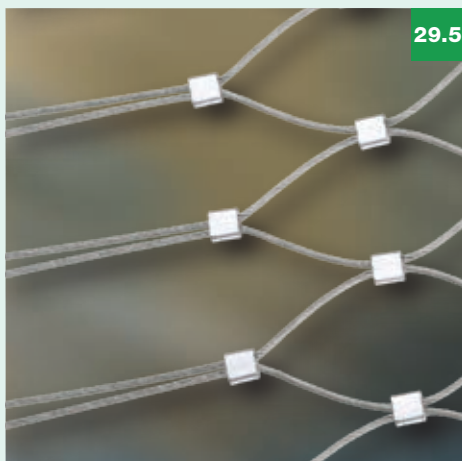

29.5

Horizontal mesh perimeter:
closed with uncompressed sleeves at left



29.6

Horizontal mesh perimeter:
closed with Webnet eye ends at left

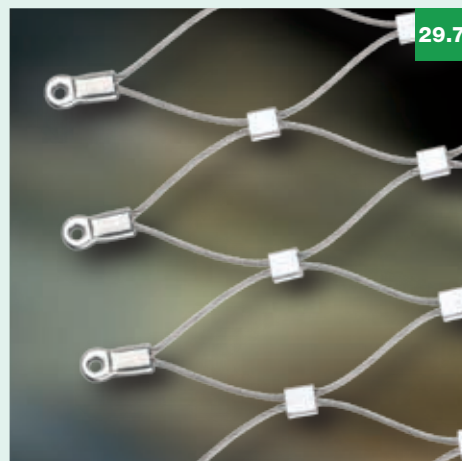

29.7

Suspension rope

Construction 6 × 7 + WC

AISI 316 material group

Part No.	Rope ϕ mm	Minimum breaking load kN	Weight kg/100 m
10820-0600	6.0	19.0	13.0
10820-0800	8.0	38.0	23.0



Wire-rope cutter

Type C12

Part No.	Max. rope ϕ mm	Length mm
30740-0800	8.0	500



VISSLINE® external thread end, right-hand

Only for rope No. 10820-

Breaking load: 90% of minimum wire-rope breaking load

AISI 316 material group

Part No.	For rope ϕ mm	a mm	b1 mm	b2 mm	c mm	ϕ d mm
30948-0600-30	6.0	M8 × 30	15.0	45	30	7.2
30948-0600-60	6.0	M8 × 60	15.0	75	60	7.2
30948-0800-30	8.0	M10 × 30	15.0	45	30	9.0
30948-0800-60	8.0	M10 × 60	15.0	75	60	9.0



Swaged external thread end, right-hand

Breaking load: 90% of minimum wire-rope breaking load

AISI 316 material group

Part No.	For rope ϕ mm	Length of thread mm	b mm	c mm	ϕ d mm
30850-0600-030	6.0	M10 × 30	85	30	10
30850-0600-060	6.0	M10 × 60	115	60	10
30850-0600-080	6.0	M10 × 80	135	80	10
30850-0800-080	8.0	M12 × 80	160	80	13
30850-0800-120	8.0	M12 × 120	200	120	13

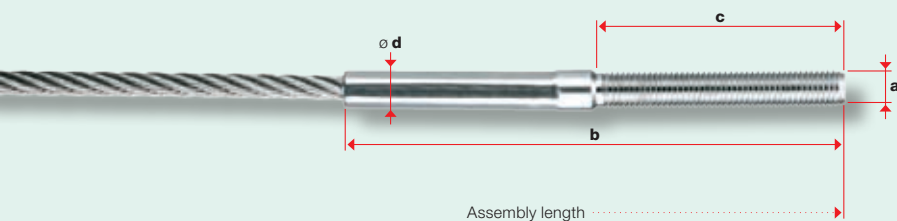

Dimension **b** is **enlarged** by 3 to 6% during the swaging process.

Screwed external thread ends LT1, right-hand

For on-site assembly with rope No. 10820-
Breaking load: 90% of minimum wire-rope breaking load

AISI 316 material group

Part No.	For rope ϕ mm	a x length of thread mm	ϕ d1 mm	ϕ d2 mm	sw mm	b1 mm	b2 mm	c mm
30826-0600-030	6,0	M8 x 30	14	17,1	15	92	62	30
30826-0600-060	6,0	M8 x 60	14	17,1	15	122	62	60
30826-0600-031	6,0	M10 x 30	14	17,1	15	92	62	30
30826-0600-061	6,0	M10 x 60	14	17,1	15	122	62	60
30826-0600-081	6,0	M10 x 80	14	17,1	15	142	62	80
30826-0800-061	8,0	M10 x 60	22	25,4	22	140	83	60
30826-0800-081	8,0	M10 x 80	22	25,4	22	160	83	80
30826-0800-080	8,0	M12 x 80	22	25,4	22	160	83	80
30826-0800-120	8,0	M12 x 120	22	25,4	22	200	83	120



Not suitable for **stranded wire No. 10810-**

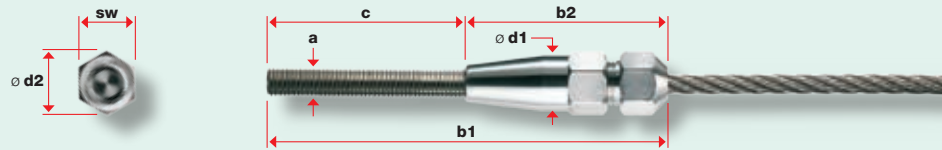

Correct assembly and the choice of the proper wire-rope diameter are the responsibility of the user.
 Only **Jakob rope No. 10820-** assures full functionality.

Turnbuckle with MONOFORK, swaged

Breaking load: 90% of minimum wire-rope breaking load

AISI 316 material group
 Turnbuckle body (b2): chrome-plated brass

Part No.	Rope ϕ mm	a mm	b1 mm	b2 mm	ϕ d1 mm	e mm	f mm	g mm	h mm	⊕ Range mm	⊖
30870-0600-01	6.0	M10	319.5	140	9	10.5	25.5	12	21.5	60	50
30870-0800-01	8.0	M12	377	160	12	18	32	16.3	30	59	49

⊕ ⊖ Tensioning range

information: The external thread ends are both screwed in halfway.
Caution: The minimal screw insertion depth is $1.5 \times$ thread ϕ (M8 = 12 mm).

← ⊕ → = make longer (relax)
 → ⊖ ← = make shorter (tension)

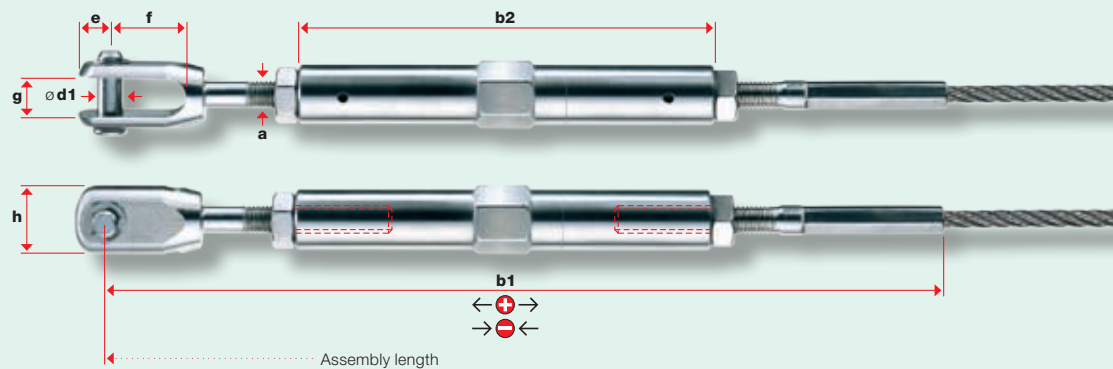

Turnbuckle with MONOFORK, screwed

For on-site assembly with rope No. 10820-
Breaking load: 90% of minimum wire-rope breaking load

AISI 316 material group
 Turnbuckle body (b2): chrome-plated brass

Part No.	Rope ϕ mm	a mm	b1 mm	b2 mm	ϕ d mm	e mm	f mm	g mm	h mm	⊕ Range mm	⊖
30822-0600-01	6.0	M10	327.5	140	9	10.5	25.5	12	21.5	60	50
30822-0800-01	8.0	M12	385	160	12	18	32	16.3	30	59	49

⊕ ⊖ Tensioning range

information: The external thread ends are both screwed in halfway.
Caution: The minimal screw insertion depth is $1.5 \times$ thread ϕ (M8 = 12 mm).

← ⊕ → = make longer (relax)
 → ⊖ ← = make shorter (tension)

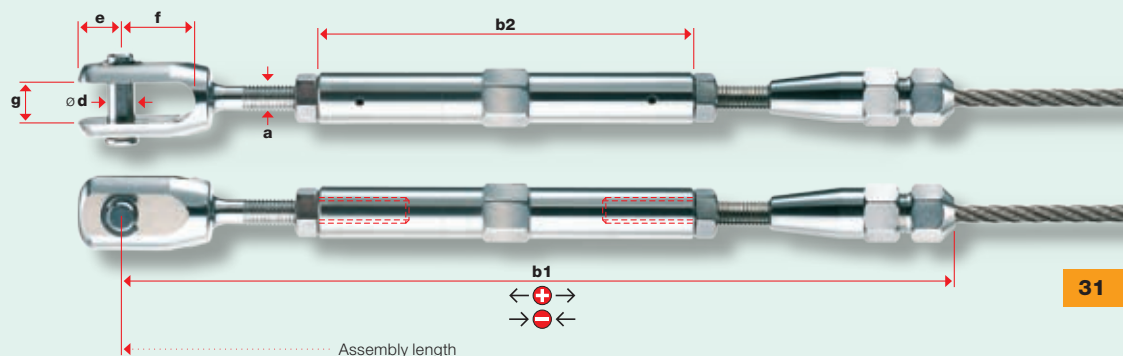

Suspension-rope clamp

AISI 316 material group

Part No.	a	c	ø d for rope
	mm	mm	mm
30858-0600-10	M8	15	6,0
30858-0600-25	M8	25	6,0
30858-0800-10	M8	15	8,0
30858-0800-25	M8	25	8,0
30858-1012-10	M12	20	10,0 – 12,0

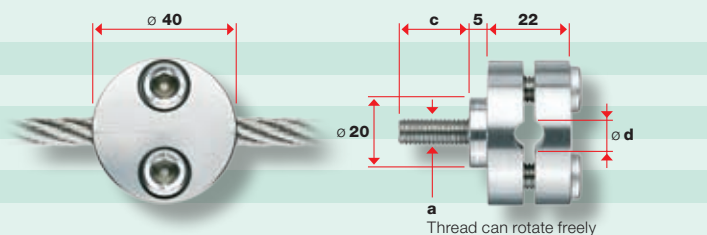

Adjustable suspension-rope clamp

AISI 316 material group

Part No.	b	c	ø d for rope connection
	mm	mm	with external threads
30858-0600-11	26,0	15	M8
30858-0600-13	26,0	25	M8
30858-0600-12	29,5	15	M10
30858-0600-14	29,5	25	M10

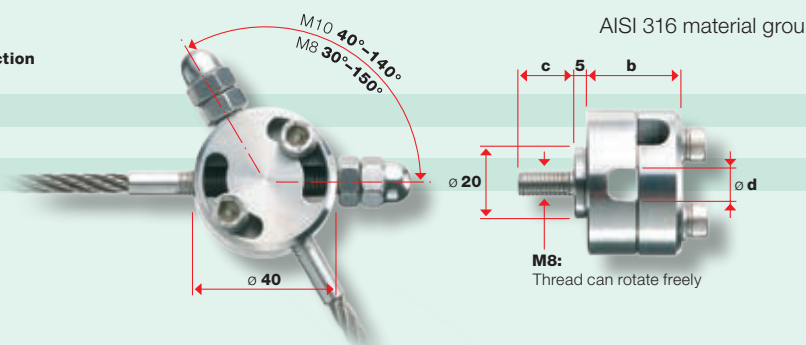

Webnet wire-rope clamp G1

For attachment to mounting structure without suspension rope

AISI 316 material group

Part No.	Hole type	For Webnet rope ø
		mm
30920-0400-00	Through hole for M8	1.5–3.0
30920-0400-05	For M5 screw with countersunk head	1.5–3.0

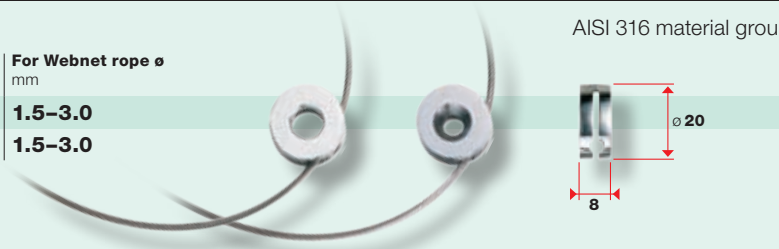

Tube, ground

Plug-in Webnet tubular frame for on-site assembly

AISI 316 material group

Part No.	b1	ø d1	k	Weight
	mm	mm	mm	kg/m
30924-0017-01	max. 2500	17.2	1.6	0,6
30924-0026-01	max. 2500	26.9	2.0	1,6
20800-0002	Costs for cut			



Tube elbow, ground

Plug-in Webnet tubular frame for on-site assembly

AISI 316 material group

Part No.	ø d1	ø d2	k	b2	b3
	mm	mm	mm	mm	mm
30924-0017-10	17.2	12	1.6	60	30
30924-0026-10	26.9	21.7	2.0	60	30

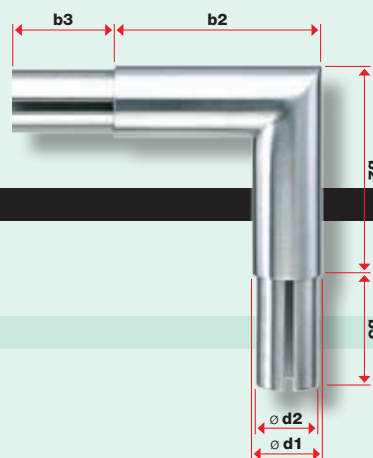

Tube connector

Connects two tubes, removable

AISI 316 material group

Part No.	For tube ø	b
	mm	mm
30924-0017-20	17.2	60
30924-0026-20	26.9	60

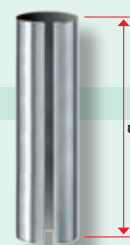

For the assembly of tubes or prefabricated tubular frames

AISI 316 material group

Part No.	Ø d for tube mm	b1 mm	b2 mm	b3 mm	c mm
30924-0017-30	17,2	68	58	20	Variable
30924-0017-31	17,2	85	75	20	Variable
30924-0017-32	17,2	110	100	20	Variable
30924-0026-30	26,9	73	58	25	Variable
30924-0026-31	26,9	90	75	25	Variable
30924-0026-32	26,9	115	100	25	Variable
30924-0017-33	17,2	A: Tube clamp, separate		20	
30924-0026-33	26,9	A: Tube clamp, separate		25	

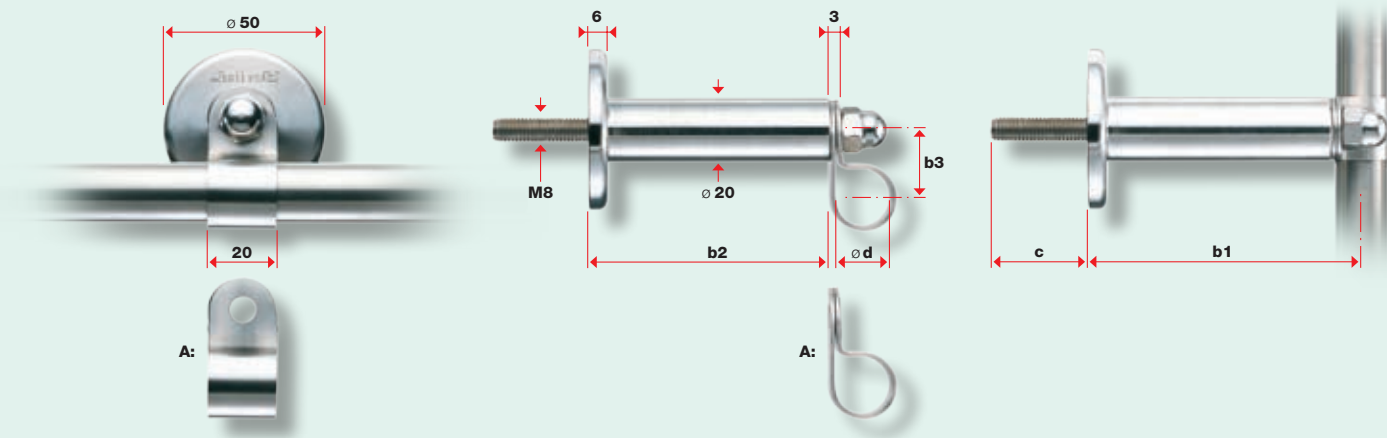

Welded Webnet tubular frame

Fully strung tubular frames according to your drawings

AISI 316 material group

Part No.	For tube Ø mm
30924-0017-40	17,2
30924-0026-40	26,9

Welded Webnet tubular frame

Fully strung tubular frames according to your needs, with the matching assembly accessories for attachment to mounting structure.

What we need from you:

- dimensioned drawing of frame with tube Ø 17.2 or 26.9 mm
- **Webnet** order No. with rope Ø and mesh aperture **W**, Type **A** or **B**
- vertical mesh **V** or horizontal mesh **H**
- number of tube holders and spacers
- description of mounting surface
- see ordering example on **page 19**

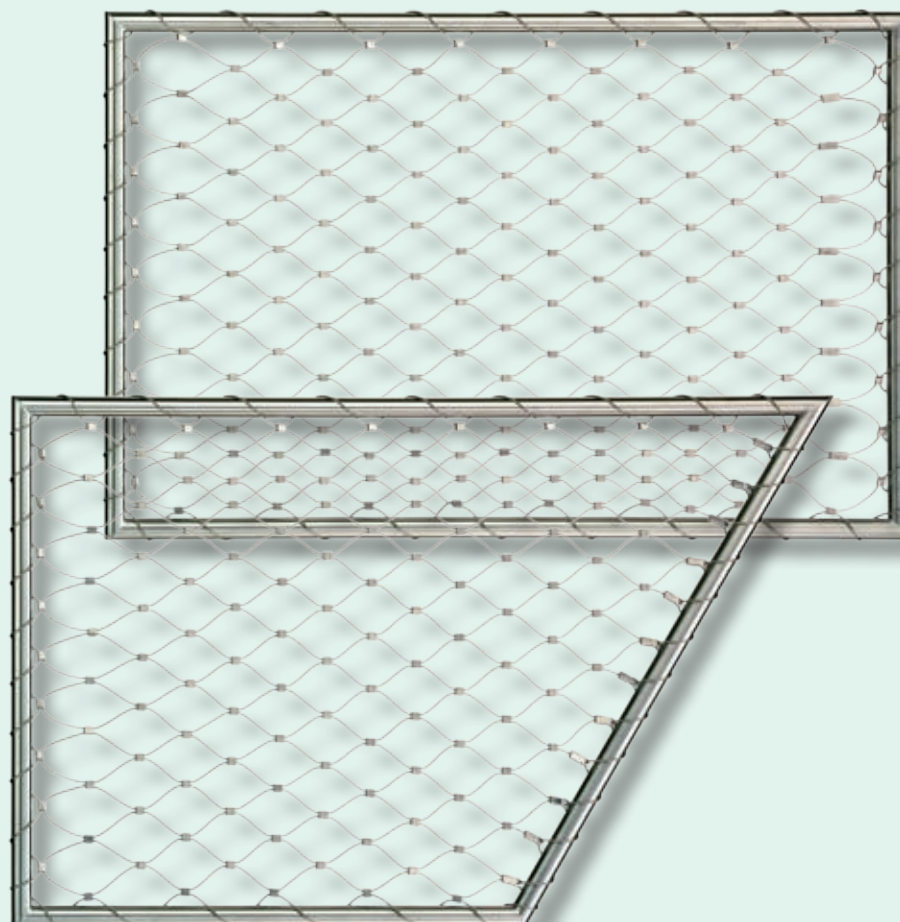

Connecting rod

Custom-made according to drilling template, see dimensions **b1**, **b2**, **b3**, **b4** and **b5**
 Round posts: indicate post diameter

AISI 316 material group

Part No.	$\varnothing d$ for rope connection with external threads	
30921-0800-20	M8	For flat posts
30921-0800-21	M8	With post fittings for round posts
30921-1000-20	M10	For flat posts
30921-1000-21	M10	With post fittings for round posts

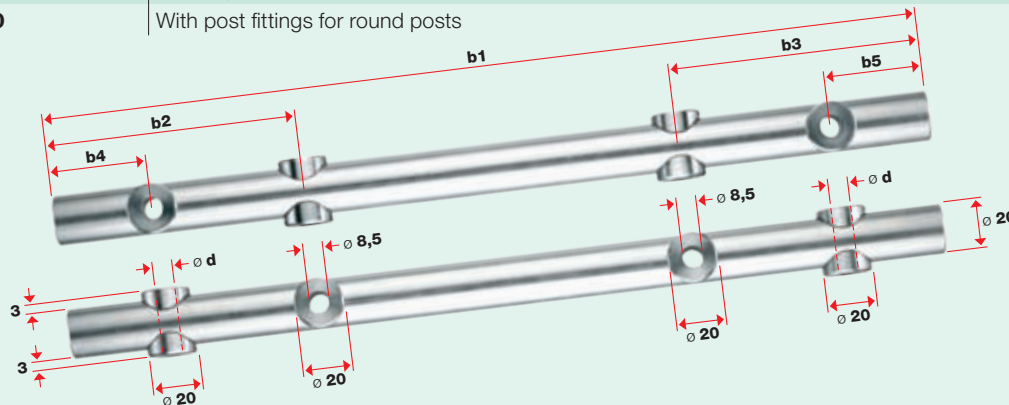

Spacer washers

To match connecting rod

AISI 316 material group

Part No.	k mm	
30922-0800-02	4	<p>Technical drawing of spacer washers. It shows three washers of different thicknesses (k) and one larger washer with an outer diameter of $\varnothing 20$ and an inner diameter of $\varnothing 8,2$.</p>
30922-0800-01	6	
30922-0800	12	

Rod $\varnothing 10$ mm

With or without external thread end M10, right-hand

AISI 316 material group

Part No.	b variable mm	Threaded mm	
30921-1000	Max. 2500	Not threaded	<p>Technical drawing of a rod with diameter $\varnothing 10$ mm and length b. A detail shows a threaded section with M10 threads and a length of 15 mm.</p>
32884-1000-011	Max. 2500	M10 \times 15 at one end	
32884-1000-012	Max. 2500	M10 \times 15 at both ends	
20800-0002	Costs for cut		

Rod connector with M10 internal threads

Connecting element for rod extensions

AISI 316 material group

Part No.	Internal threads mm	
32884-1000-03	2 \times M10 \times 19	<p>Technical drawing of a rod connector. It is a cylindrical component with a length of 38 mm and an outer diameter of $\varnothing 14$. It has two M10 internal threads.</p>

Rod articulation with M10 internal threads

Variable-angle rod-connecting element

AISI 316 material group

Part No.	Internal threads mm	
32884-1000-032	M10 \times 15	<p>Technical drawing of a rod articulation. It is an L-shaped component with a vertical leg of length 38 mm and a horizontal leg of length 34 mm. Both legs have an outer diameter of $\varnothing 14$ and an M10 internal thread.</p>

Rod holder

Matches rod \varnothing 10 mm

AISI 316 material group

Part No.

30921-1000-01

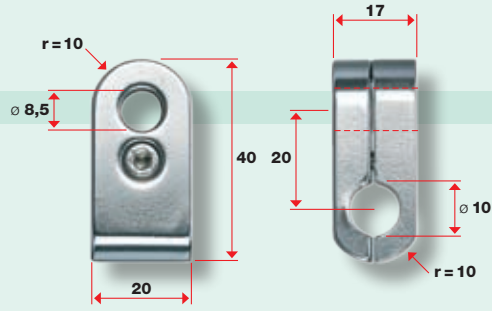

Rod holder with U-mount

Matches rod \varnothing 10 mm

AISI 316 material group

Part No.

30921-1000-10

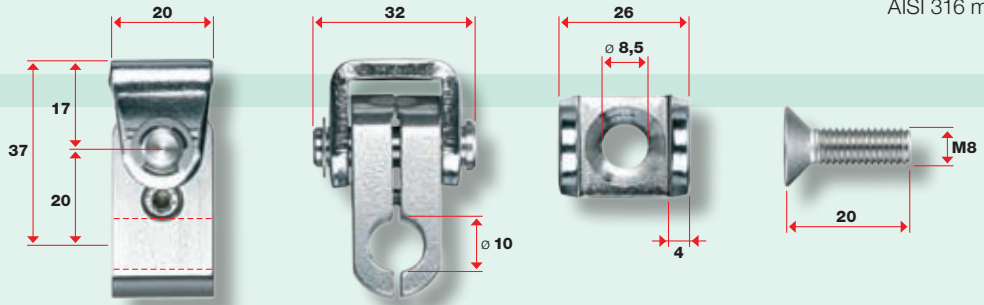

Rotating rod holder with counter washer

Matches rod \varnothing 10 mm

AISI 316 material group

Part No.

30921-1000-11

c
mm

30921-1000-13

14
29

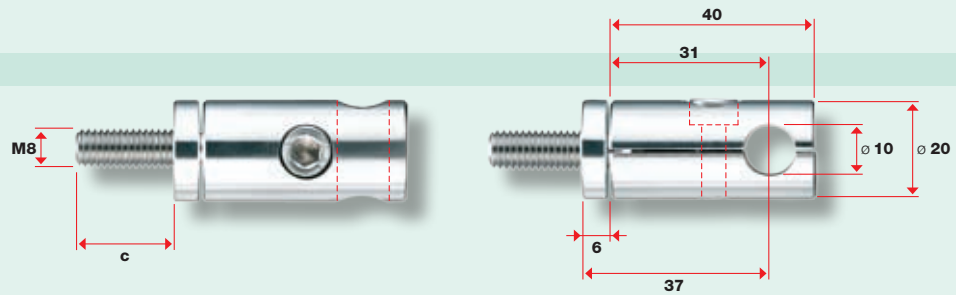

Rotating rod holder with support washer

Matches rod \varnothing 10 mm

AISI 316 material group

Part No.

30921-1000-12

c
mm

30921-1000-14

14
29

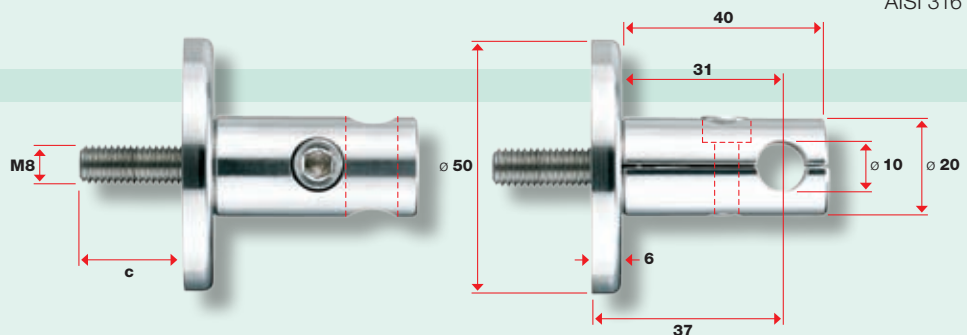

Rod holder, tensionable

Matches rod \varnothing 10 mm

AISI 316 material group

Part No.

30921-1000-15

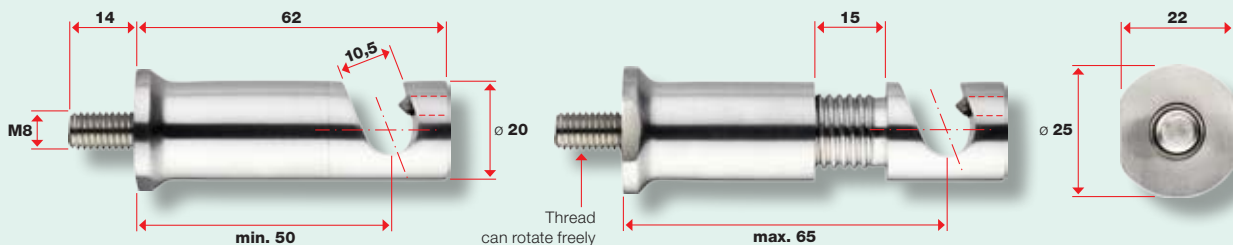

Spacer Ø 20/50

Matches rod holder No. **30921-1000-01**

AISI 316 material group

Part No.	b mm	c1 / c2 mm
30919-0058	58	Variable
30919-0075	75	Variable
30919-0100	100	Variable

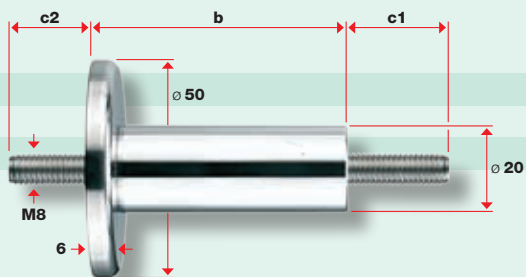

Support washer with threaded rod

Support washer with internal thread M8

AISI 316 material group

Part No.	c1 / c2 mm
30919-0050-01	Variable

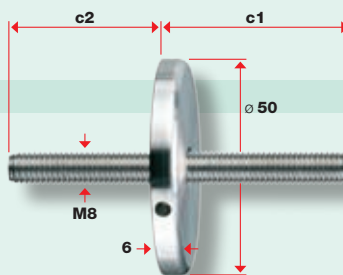

Lake of Geneva/Montreux (Switzerland)

Removable floating debris barrier

- Webnet rope Ø 3.0 mm, mesh aperture 50 mm
- Fully strung tubular frames



36.1

36.2

36.3

36.4

Eye nut

With internal thread M8, DIN 582

AISI 316 material group

Part No.

30838-0800

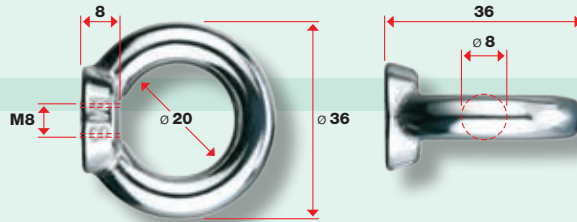

Quick coupling for suspension rope Ø 6 and 8 mm

Load data not guaranteed

AISI 316 material group

Part No.

30895-0700

Permissible load

kN

5

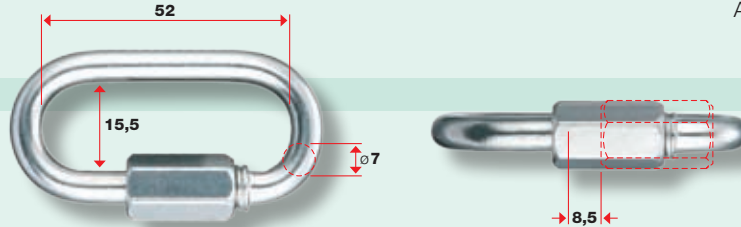

Webnet clip

Compatible with Webnet rail

AISI 316 material group

Part No.

30925-0001

For rope ø

mm

1.0 – 1.5

b

mm

15.5

h

mm

12

k

mm

8

30925-0002

2.0 – 3.0

15.5

12.5

8

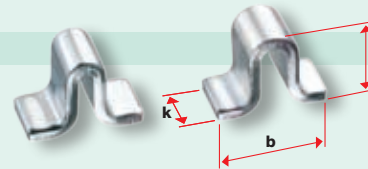

Webnet C rail

Compatible with Webnet clip

AISI 301–304 material group

Part No.

30925-0010

b

mm

max. 2500

Typ

A Webnet C rail

30925-0011

max. 2500

B Countersunk hole, ø 5.5 mm (positions according to your specifications)

30925-0012

max. 2500

C Welded flange (positions according to your specifications)

30925-0013

max. 2500

Separate flange

30925-0014

max. 2500

D Welded stud (positions according to your specifications)

30925-0015

max. 2500

Separate stud

20800-0002

Costs for cut

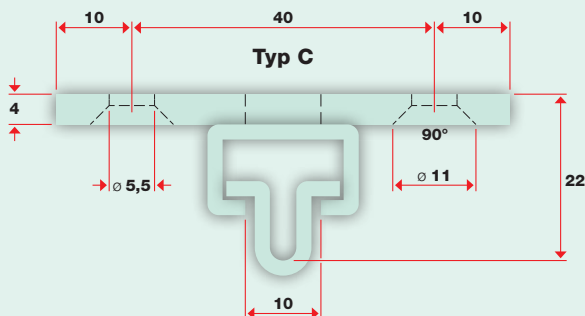
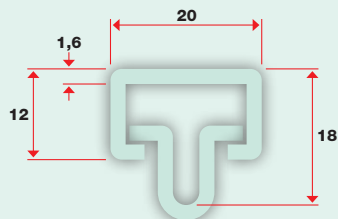
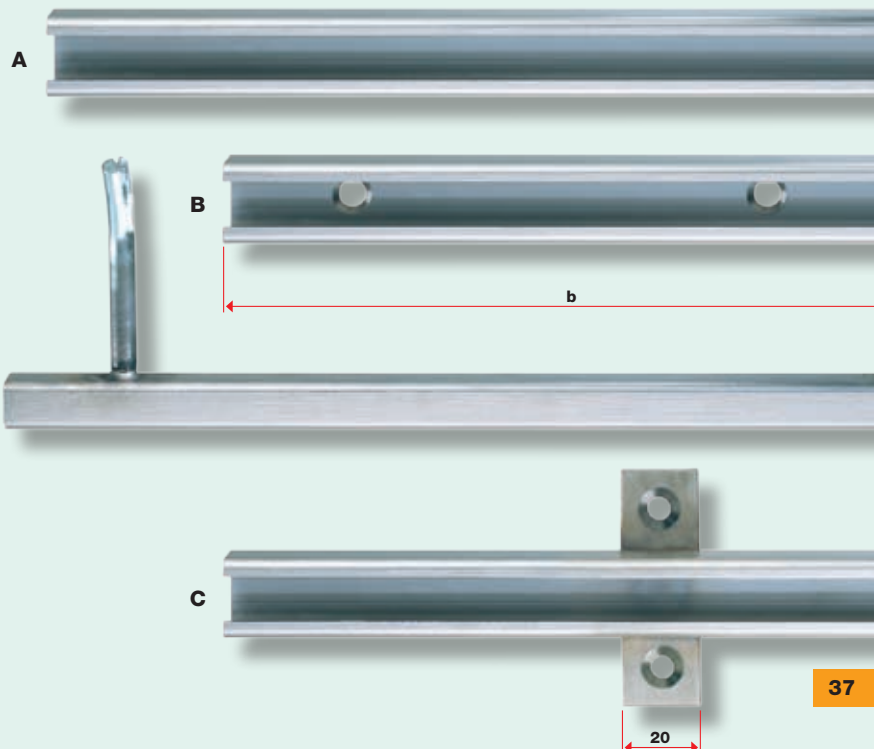

Webnet perimeter rope

Construction 6 × 7 + WC (* Ø 3 mm: 6 × 19 + WC)

AISI 316 material group

Part No.	Rope ø mm	Minimum breaking load kN	Weight kg/100 m
10820-0100-42	1.0	0.5	0.41
10820-0150	1.5	1.4	0.88
10820-0200	2.0	2.4	1.57
10830-0300	3.0 *	5.8	3.60



Webnet perimeter strand

Construction 1 × 19

AISI 316 material group

Part No.	Strand ø mm	Minimum breaking load kN	Weight kg/100 m
10810-0100	1.0	1.0	0.53
10810-0150	1.5	2.2	1.15
10810-0200	2.0	3.8	2.12
10810-0300	3.0	8.4	4.42



Wire-rope cutter

Part No.	Max. rope ø mm	Length mm
30740-0500-01	5.0	190
30740-0800	8.0	500

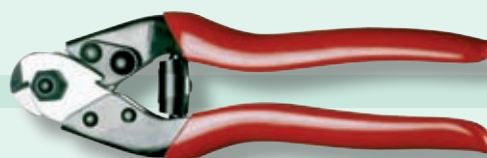

Webnet sleeves

Matches Webnet perimeter rope and Webnet perimeter strand, available in two materials

Materials: E-CU Sn (tin-plated copper) and AISI 316

AISI 316 sleeves can only be swaged with **Webnet swaging tool type 2**

Part No. Tin-plated copper	Part No. AISI 316	For wire rope and stranded wire ø mm	b mm	ø d mm
30582-0100	30584-0100	1.0	4	4
30582-0150	30584-0150	1.5	7.3	5.7
30582-0200	30584-0200	2.0	10	7
30582-0300	30584-0300	3.0	11	8.3
30582-0300-01	30584-0300-01	3.0	11	10.7

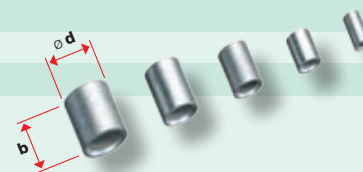

Webnet swaging tool type 1

For **on-site** swaging of Webnet sleeves made of tin-plated copper (see example on page 49)

Part No.	Max. rope ø mm	Length mm
30570-1500	1.5	250
30570-2000	2.0 – 3.0	300



On-site swaging and the choice of the correct rope or stranded-wire diameter with the matching Webnet sleeves and eye ends are the responsibility of the user. Full functionality is guaranteed only with **Jakob wire ropes and stranded wire** and **original Webnet swaging tools**.

Webnet eye ends

Matches Webnet rope and Webnet strand

AISI 316 material group

Part No. for one rope	Part No. for two ropes	For wire rope and stranded wire ϕ mm	b mm	ϕ d mm	h mm	k mm
30880-0100-02	30880-0100-01	1.0	13	2	5	2.5
30880-0150-02	30880-0150-01	1.5	16	3	8.3	3
30880-0200-02	30880-0200-01	2.0	20	4.5	10	3
30880-0300-02	30880-0300-01	3.0	30	5	14	5

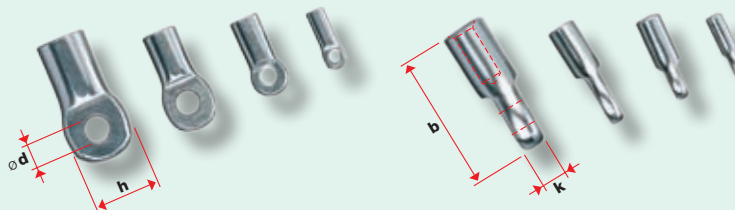

Webnet swaging tool type 2

For **on-site** swaging of AISI 316 Webnet sleeves and eye ends

Part No.	Max. rope ϕ sleeves mm	Max. rope ϕ eye ends mm	Length mm
30570-2001	1.0 – 3.0	1.0 – 2.0	400
30570-2001-01	Tool inserts		



Battery-powered swaging tool

For **on-site** swaging of Webnet eye ends
Tools must be ordered separately

Part No.	For rope ϕ mm	Type	Weight kg
30570-2004	1,0 – 1,5	EK 35/4	1,6
30570-2003	1,0 – 3,0	EK 22	4,2
Tool inserts for type EK 35/4:			
30570-0004-10	1,0		
30570-0004-15	1,5		
Tool inserts for type EK 22:			
30570-0003-10	1,0		
30570-0003-15	1,5		
30570-0003-20	2,0		
30570-0003-30	3,0		

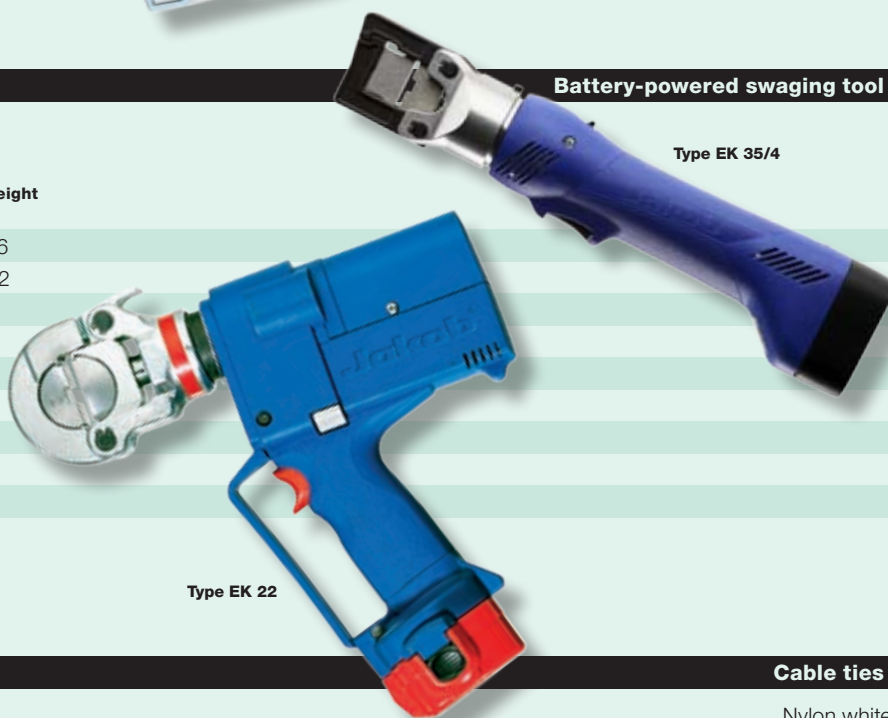

Type EK 35/4

Type EK 22

Cable ties

Webnet assembly accessories (see example on page 49)

Nylon white

Part No.	Length mm
30916-0001	120
30916-0002	160
30916-0003	270
30916-0004	330

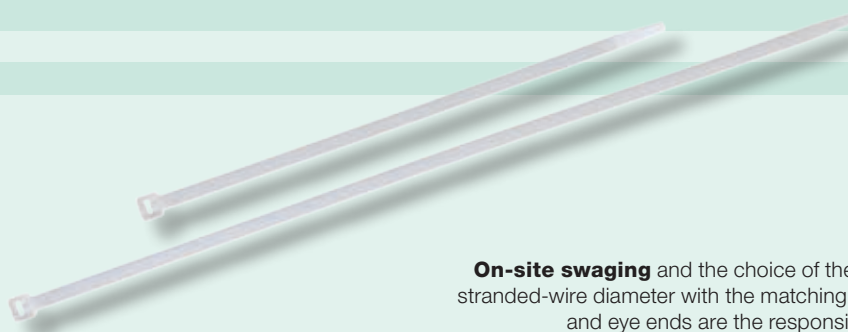

On-site swaging and the choice of the correct rope or stranded-wire diameter with the matching Webnet sleeves and eye ends are the responsibility of the user. Full functionality is guaranteed only with **Jakob wire ropes and stranded wire** and **original Webnet swaging tools**.

Hexagon head cap screw M8

DIN 933 AISI 316 material group

Part No.	c mm
30843-0800-016	M8 × 16
30843-0800-025	M8 × 25
30843-0800	M8 × 40

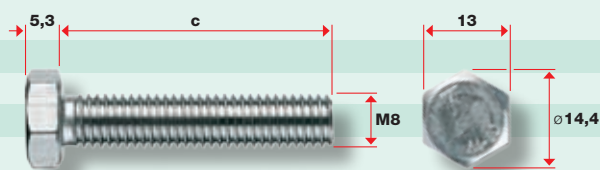

Socket head screw M8

DIN 912 AISI 316 material group

Part No.	c mm
30844-0800-016	M8 × 16
30844-0800-025	M8 × 25
30844-0800	M8 × 35

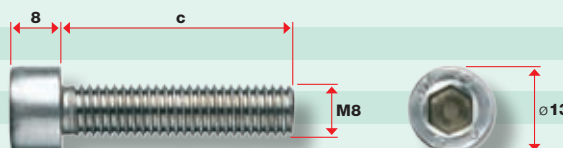

M8 threaded rod

AISI 316 material group

Part No.	c mm
30882-0800	M8 × variable

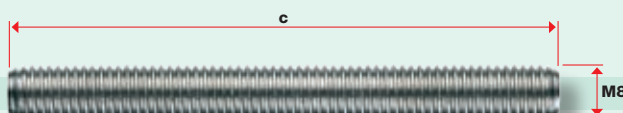

Dual thread screw M8

With Phillips head AISI 316 material group

Part No.	Length mm
30990-0010	50
30878-0800	100

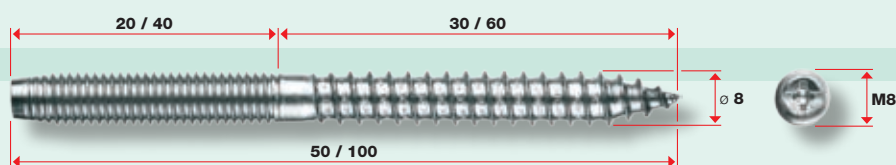

M8 nuts

AISI 316 material group

Part No.	Type
30892-0800-02	DIN 985 lock nut
30892-0800	DIN 934 hexagon nut
30894-0800	DIN 1587 dome nut

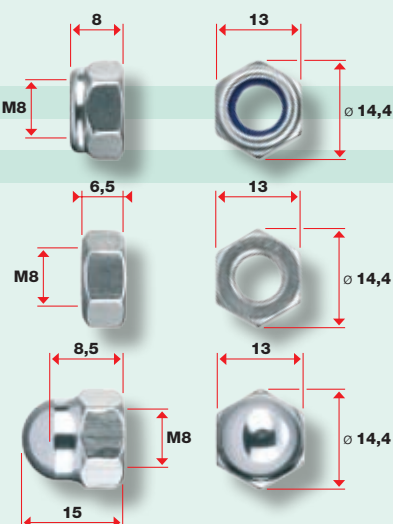

M8 washers

AISI 316 material group

Part No.	Type
30896-0800	ø d 15 mm, DIN 433
30896-0800-24	ø d 24 mm, DIN 9021 for wood

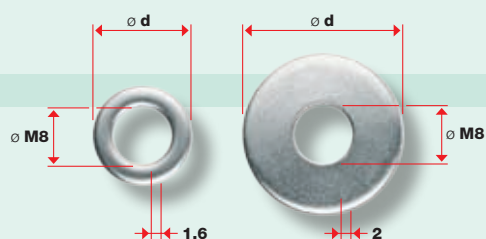

Wall anchor with internal thread RH M8

Suitable exclusively for concrete

Galvanized steel

Part No.	Internal threads
30803-0800-02	M8

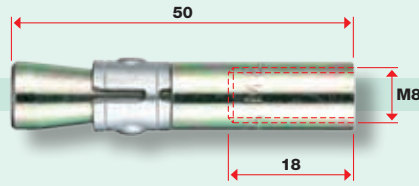

FIS VS 150 C injection mortar with perforated sleeve HK

For hollow and solid walls

Part No.	Product
30803-0800-05	1 cartridge 145 ml with plunger disc, 2 mixer nozzles, 6 perforated sleeves HK
30803-0800-052	Mixer nozzle, separate
30803-0800-053	HK perforated sleeve, separate
30803-0800-051	Dispenser gun

FIS VS 150 C injection mortar is a 2-component resin mortar. The perforated sleeve is needed only for hollow masonry. The threaded rod can be glued directly into the hole of a concrete wall.



Rampa screw-in nut for wood RH M8

With hex socket, type SK, ~DIN 7965

Galvanized steel

Part No.	Internal threads
30803-0800-04	M8



Thread lock fluid VC3

Protects screws and nuts against spontaneous loosening

Part No.
30879-0001

The thread flanks must be filled at least $\frac{2}{3}$ of the way.

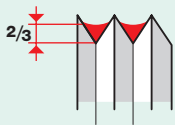

Thread lock fluid VC3 is a lacquer-like coating that contains two separate, microencapsulated components.

The safety function is activated when the fluid is compressed as the threaded fastener is closed. The fastener is then protected against vibration; screws and nuts can no longer work themselves loose.

41.1





42.1



Office building in Logrono (E)

- Webnet rope \varnothing 1.5 mm, mesh aperture 100 mm
- Webnet size total: 2200 m²



42.2

42.3





43.1



43.2

Enclosure at the Dublin Zoo (Ireland)
Webnet size 420 m²

- Periphery structure: stranded wire Ø 10.0 mm
- Webnet rope Ø 1.5 mm
- Webnet mesh aperture 40 mm

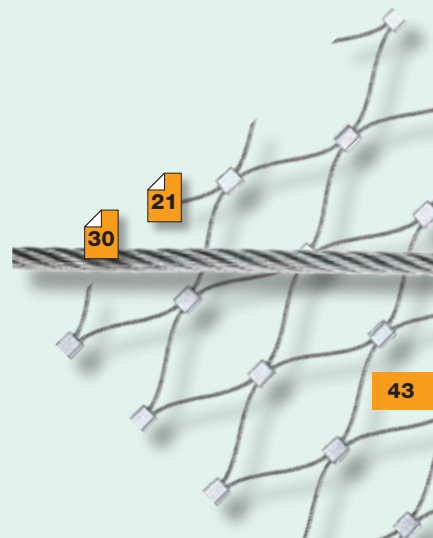

43



44.1 44.3



44.4



44.2



44.5

KNIE'S children's zoo, Rapperswil (Switzerland) Jungle zone, Webnet size 700 m²

- Periphery structure, stranded wire Ø 22.0 mm
- Webnet rope Ø 1.5 mm
- Webnet mesh aperture 40 mm

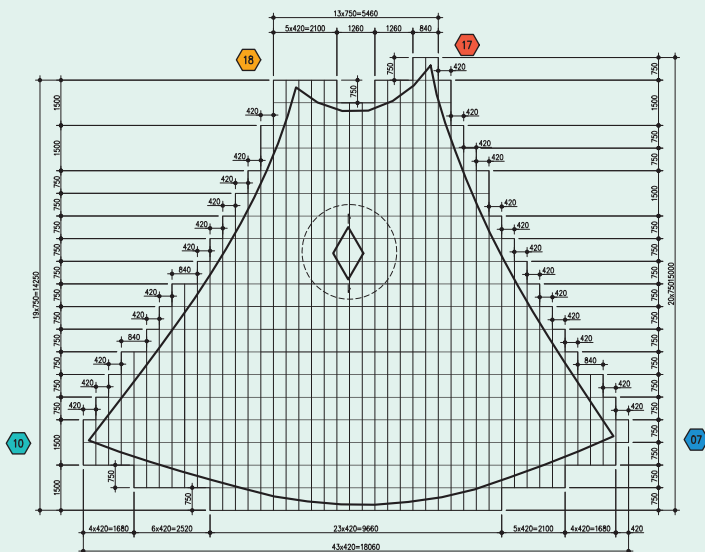
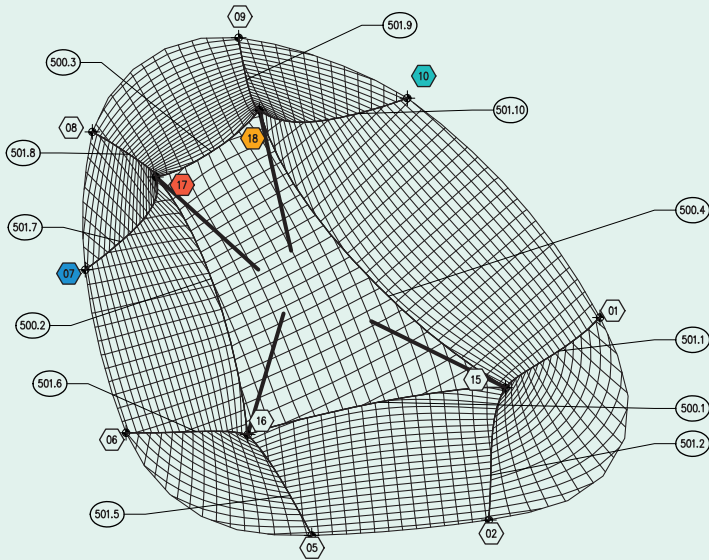
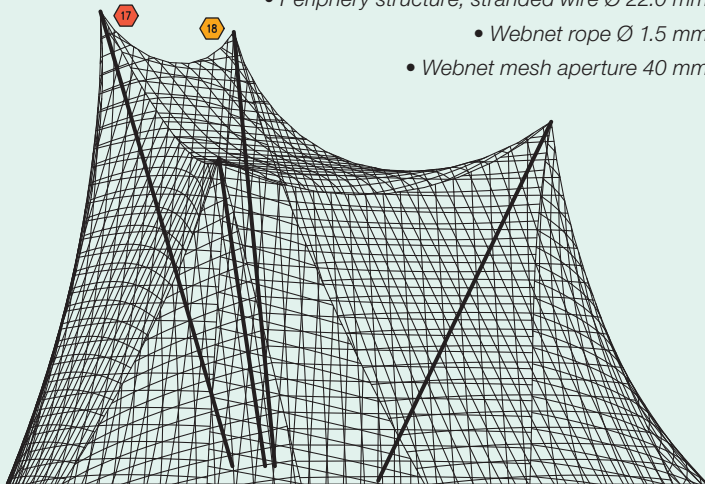

45.1



45.2



45.3



45.4



Webnet projections

Jakob AG can serve you with turnkey, all-in-one solutions. On request, you can also obtain separate services such as consulting and planning, engineering, or the assembly of complex wire-rope structures.

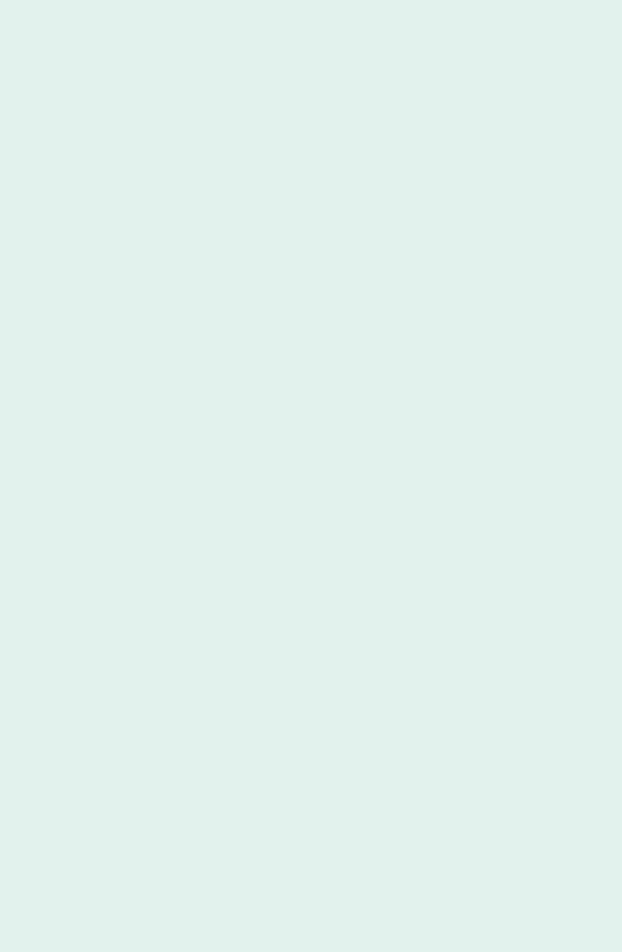

46.1

46.2

46.3



The **Jakob® INOX LINE Webnet** is ideal for **protective functions** and offers intelligent solutions for **attachment** and **perimeter design**.

Combined with architectural wire ropes and the acclaimed **Jakob® INOX LINE G1** greening system, its range of applications extends beyond protection and support, functioning as a **training system** for plants in façade greening applications. Additionally, the Webnet opens up completely new dimensions for the aesthetic design of multifunctional barriers or as “passive safety systems” wherever rugged but resilient fall-stopping nets are needed.

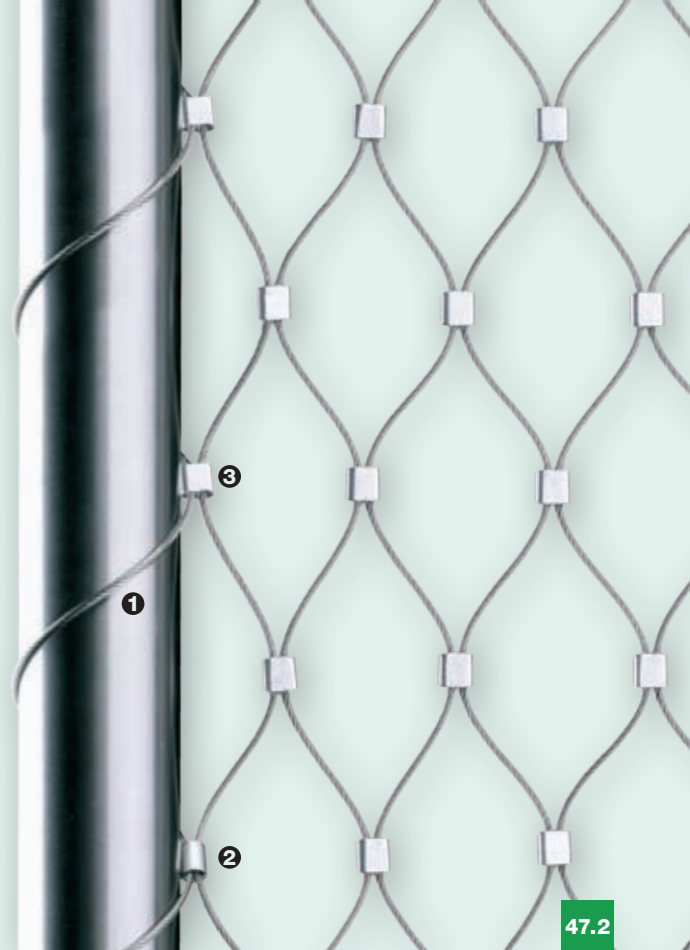

Left:

Webnet type A mounted on a tube with perimeter rope ① and hollow sleeves ②

The sleeves are swaged on site with a hand-operated tool ③



Rankhof Stadium, Basel (Switzerland)

- Webnet rope \varnothing 2.0 mm, mesh aperture 40 mm
- The Webnet can be retensioned in the horizontal direction

48.1



48.2



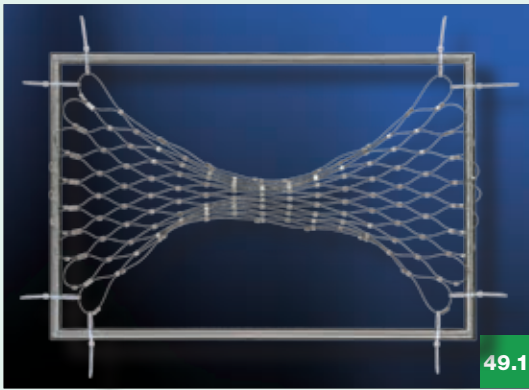

49.1

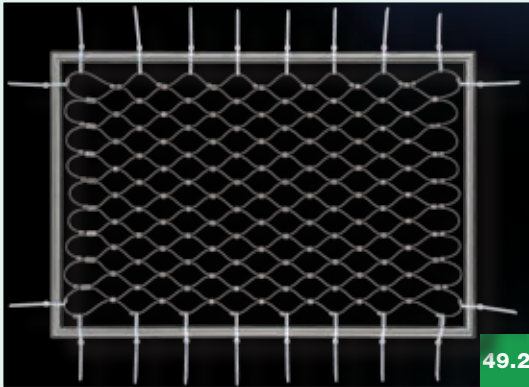

49.2



49.3



49.4



49.5



49.6

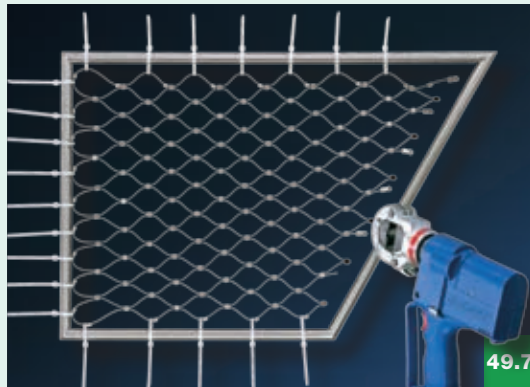

49.7



49.8

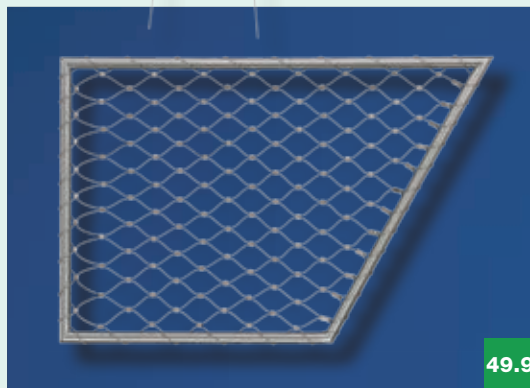

49.9

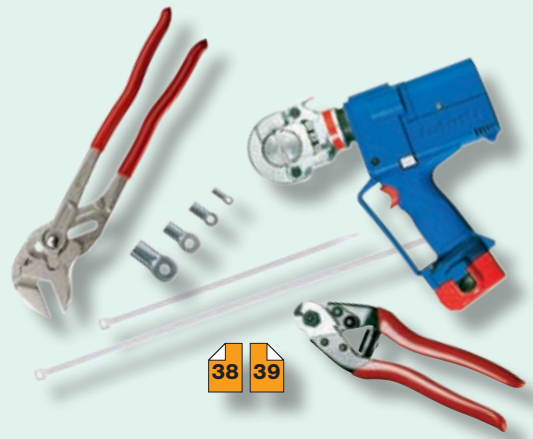

38 39

Webnet assembled in a rectangular tubular frame

Assembly example with horizontal meshes (**type A, H18**):

49.1 Center and attach Webnet at the four corners with cable ties.

49.2 Center and tension Webnet with cable ties.

49.3 On one half of the frame, thread perimeter rope from the middle of the top cross member to the middle of the bottom cross member, going through each Webnet sleeve and around the tubular frame opposite each sleeve. Thread in same direction throughout.

49.4 Thread perimeter rope on the other side of the frame as described in step 49.3. The ends of both perimeter ropes must be threaded through the last sleeve and then pulled taut. Now, all cable ties can be removed.

49.5 Swage the sleeves with the Webnet swaging tool, and cut off loose ends of the perimeter rope.

Webnet assembly in a trapezoidal tubular frame

Assembly example with horizontal meshes (**type A, H9**):

49.6 Center and tension Webnet with cable ties. Mark all cutoff points along and parallel to the skew side, and cut.

49.7 Use the battery-powered swaging tool to swage the Webnet eye ends onto the loose ends of the wire rope.

49.8 and 49.9 Same procedure as in figs. 49.4 and 49.5.



50.1

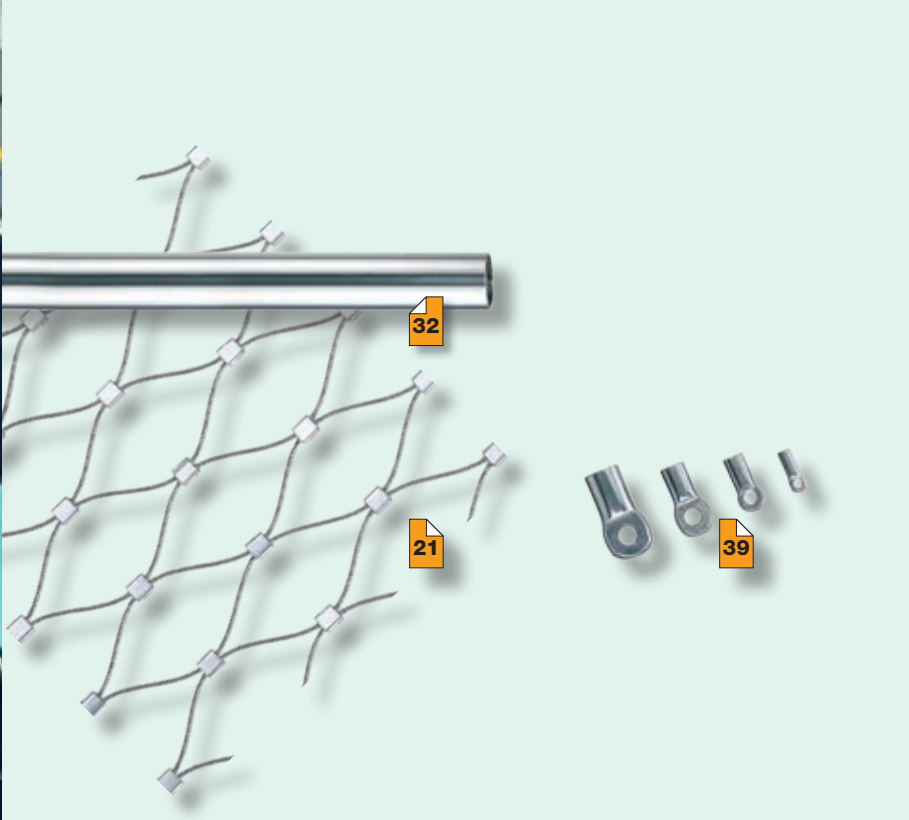

Diving tower, open-air pool in Burgdorf (Switzerland)

- Webnet rope \varnothing 1.5 mm, mesh aperture 100 mm



50.2

Welded Webnet tubular frame

Fully strung tubular frames according to your dimension sheets, with matching assembly accessories for attachment on the mounting structure.

What we need from you:

- dimensioned drawing of frame with tube \varnothing 17.2 or 269 mm
- Webnet order No. with rope \varnothing and mesh aperture **W**, type **A** or **B**
- vertical mesh **V** or horizontal mesh **H**
- number of tube holders and spacers
- description of mounting surface
- see ordering example on **page 19** and items on **page 33**



Fig. 51.1

Trapezoidal tubular frame with Webnet mesh **H**
Rope \varnothing 1.5 mm, mesh aperture 60 mm



Fig. 51.2

Rectangular tubular frame with Webnet mesh **H**
Rope \varnothing 1.5 mm, mesh aperture 60 mm



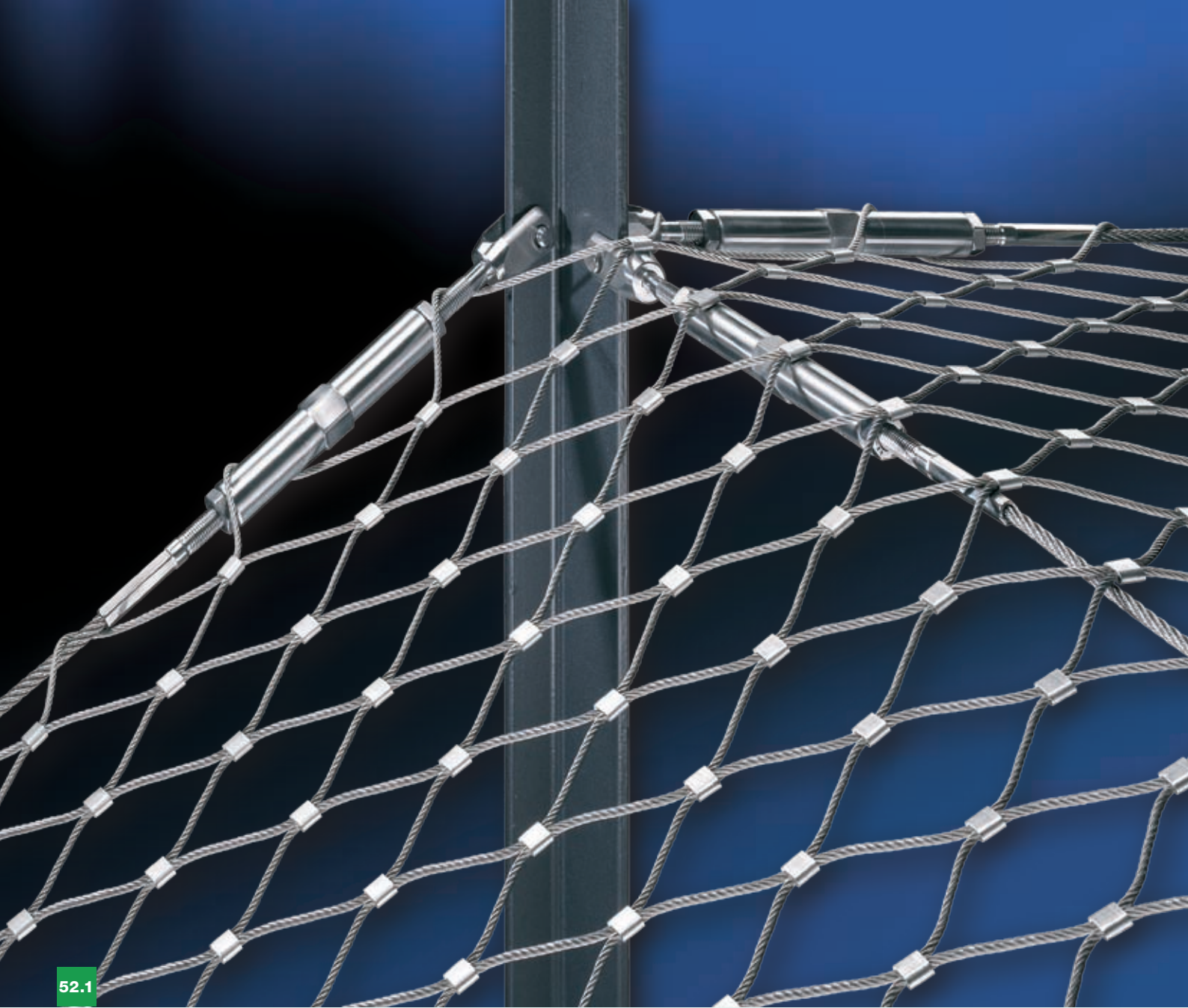

52.1

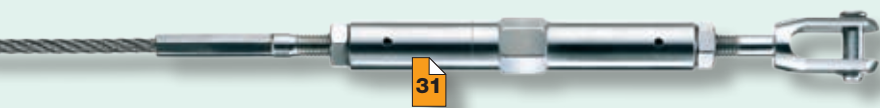

31

Design barriers, railings, and planar net structures with **Webnet**. The required periphery structure is created with suspension ropes and appropriate rope-end connectors. Further intelligent components such as suspension-rope clamps or connecting rods from the **Jakob**® INOX LINE series can be used to refine the Webnet periphery structure (see pages 30 to 36).



30

21

34

40

32

53.1

53.2



54.1



54.2

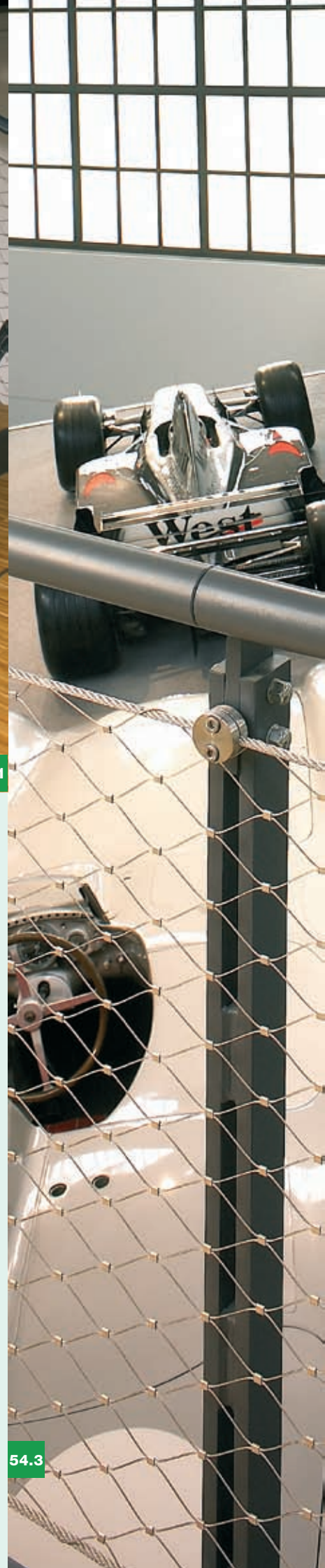

54.3

The **Jakob® INOX LINE Webnet** is ideal for elegant **protective nets** and offers intelligent solutions for **attachment** and **perimeter design**.



**Deutsches Museum, Transportation Center
Munich (Germany)**

- Suspension rope Ø 8.0 mm
- Webnet rope Ø 1.5 mm, mesh aperture 60 mm

55.1





56.1





57.1

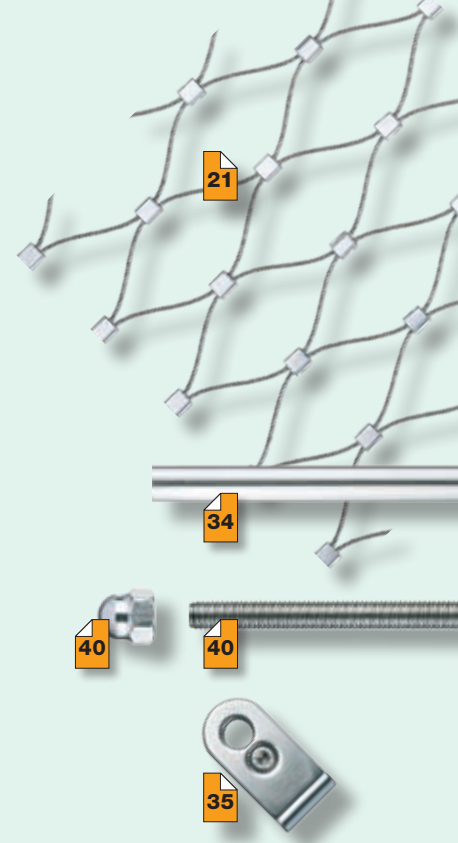

The **Webnet** can also be mounted along wavy and irregular surfaces, for instance quarry walls and natural stone walls. Loopholes can be prevented with contour adjustments.

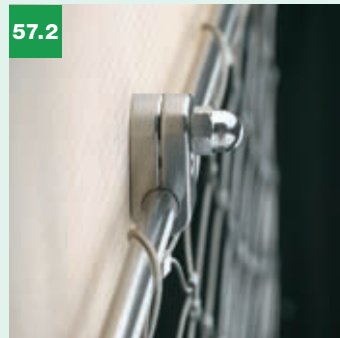
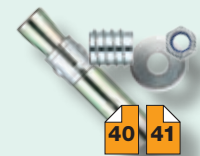

57.2



57.3



59.1



The Jakob® INOX LINE Webnet was tested pursuant to EN 1263-1 for its static and dynamic load-bearing capacity.

Test data:

- **Webnet** size: length 7 m × width 5 m
- **Webnet** rope Ø 3.0 mm, mesh aperture 60 and 100 mm (horizontal and vertical meshes)
- **Webnet** rope Ø 2.0 mm, mesh aperture 60 and 100 mm (horizontal and vertical meshes)
- suspension rope Ø 10.0 mm
- test object: 500-mm steel sphere, mass 100 kg
- drop height of test object: 7 m

*Historic city wall, Münsterplattform, Bern (Switzerland)
Safety net as a discreet passive safety system*



59.2

59

**Wooden bridge Sachseln-Kerns
(Switzerland)**

Safety net as a passive safety system

- Highest bridge of this type in Europe,
120 m above water level
- Suspension rope \varnothing 16.0 mm
- Webnet rope \varnothing 3.0 mm,
mesh aperture 100 mm

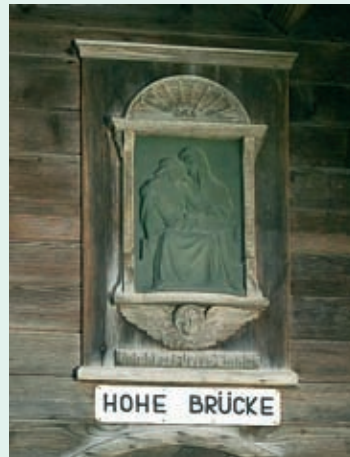

60.1



60.2



60.3

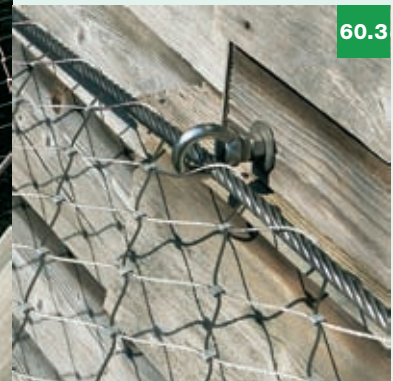

60.4



60.5





The **Jakob® INOX LINE rod system** in combination with **Webnet** sections offers a vast spectrum of configuration options that fulfill both technical and design requirements (see pages 34/35).

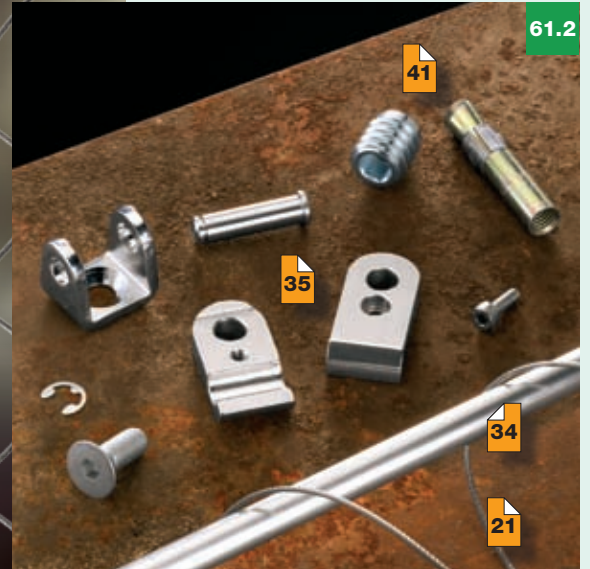



62.1





63.1

The **Jakob® INOX LINE rod system** in combination with **Webnet** sections offers a vast spectrum of configuration options that fulfill both technical and design requirements (see pages 34/35).

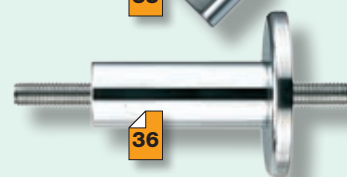
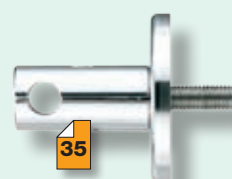
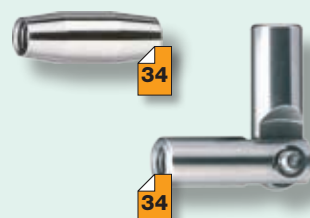

63.2





64.1

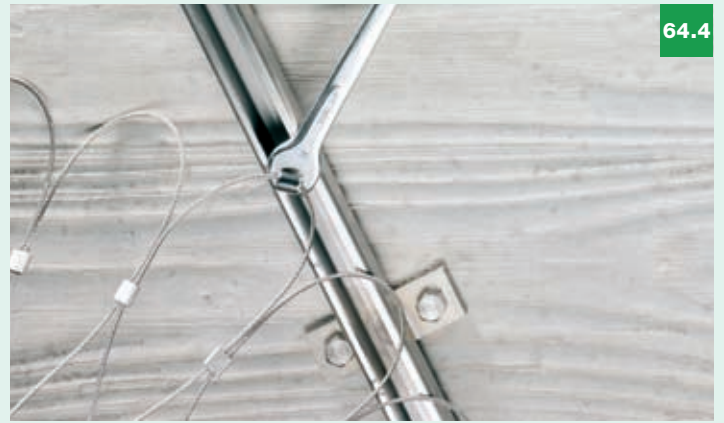

64.4

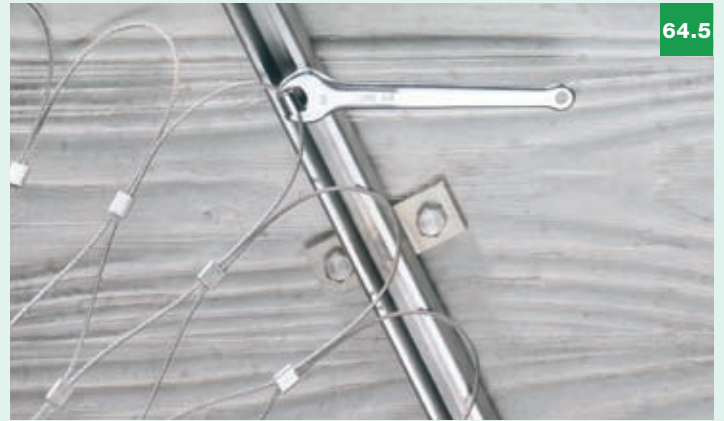

64.5



64.2



64.3



64.6

The **Jakob® INOX LINE C rail system** allows flush mounting of Webnet sections to structural surfaces. Four different C rail types are available for assembly on different kinds of substrates.

Combined with the **Jakob® INOX LINE rod system**, these rails allow the development of new and creative solutions with many configuration options (see pages 34 to 37).

**Overhead coverage
for Roman mosaic (CH)**

Protection device

- C rail, horizontal
- Holding rope \varnothing 6.0 mm, vertical
- Webnet rope \varnothing 2.0 mm,
Mesh aperture 140 mm
- Diagonal rod with clevis end M10

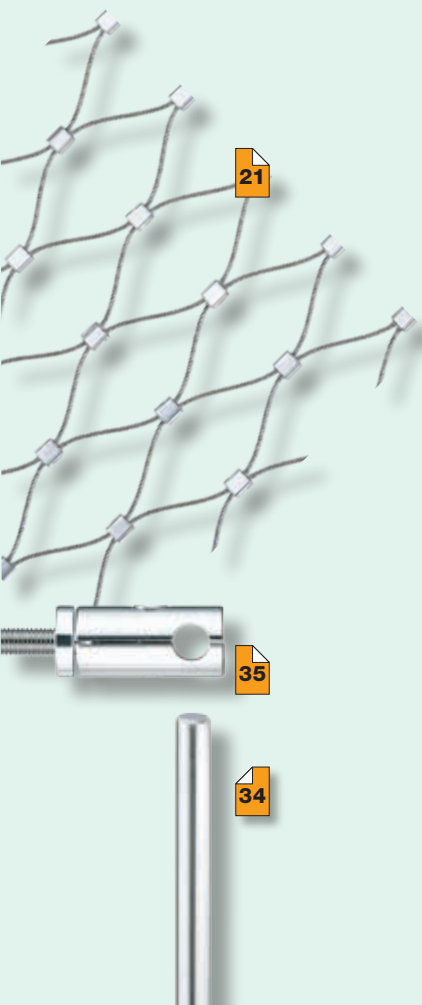

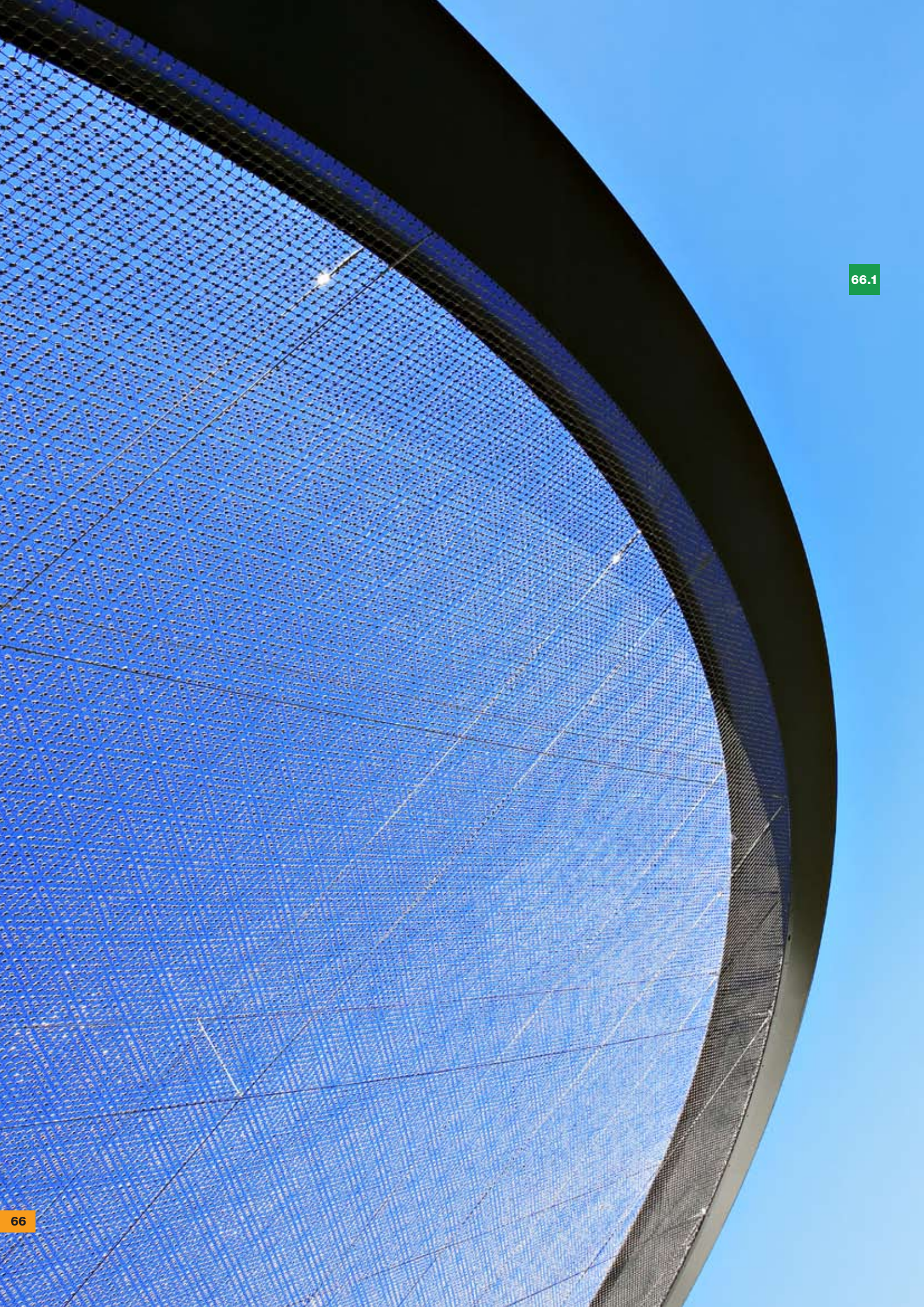

Wahlenpark, Zürich (CH)

Ball catcher net

- Webnet rope Ø 2,0 mm, mesh aperture 50 mm

Shading canopy

- Webnet rope Ø 1,5 mm, mesh aperture 30 mm
- Webnet size total: 600 m²



67.1



67.4

67.2

67.3



The so-called **moiré** (from French moirer: to marble) effect is achieved by superimposing two nets. It creates an interference pattern when two grids or sets of lines are overlaid at an angle.



68.1

68.2

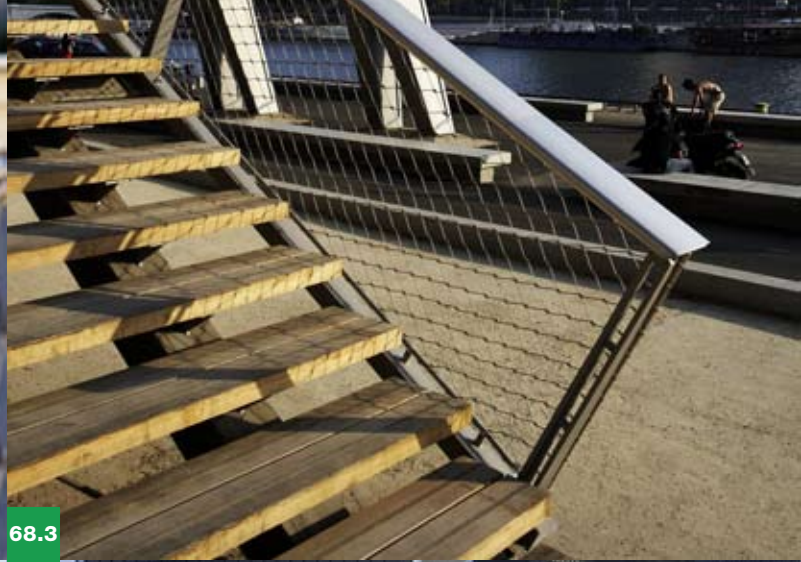

68.3

68.4



Pedestrian crossing Simone de Beauvoir, Paris (F)

- Webnet rope \varnothing 3.0 mm, mesh aperture 80 mm
- Webnet size total: 1000 m²



69.1

69.2





70.1



70.2



Eiffel Tower, Paris (F)

Protection against urban climbers

- Webnet rope-Ø 1.5 mm, mesh aperture 30 mm



70



70.3

Parking garage Sihlcity, Zürich (CH)

- Webnet rope \varnothing 1.5 mm, mesh aperture 40 mm
- Webnet size total: 1900 m²

71.1



71.3



71.2





72.1



72.2



72.4



72.3

Parking garage Sihlcity, Zürich (CH)

Webnet structure as a closed cylinder

- Webnet rope \varnothing 1.5 mm, mesh aperture 40 mm
- Webnet size total: 1900 m²



73.1

73.2

73.3





74.1

74.2



Staircase, Langnau i.E. (CH)

- Webnet rope Ø 1.5 mm, mesh aperture 40 mm
- Webnet size total: 57 m²



75.1



75.2



75.3



76.3

76.4

76.1

76.2

Krakow Zoo (PL)

Enclosures for animals

- Webnet rope Ø 2,0 und 3.0 mm, mesh aperture 80 mm
- Webnet size total: 1800 m²



77.1

77.3

77.2





78.1

79.2



79.3



Designers' Saturday, Langenthal (CH)

Webnet exhibit

- Webnet rope \varnothing 1.5 mm, mesh aperture 40 mm
- Webnet size total: 200 m²

79.1



The Crossnet by Jakob® INOX LINE

Crossnet stands for a sophisticated combination of stainless steel wire rope and connecting elements.

The new cross clamp is both elegant and unobtrusive. The ample configuration latitude provided by **Crossnet**, such as the variable mesh aperture in combination with our proven rope-end connectors, is a challenge to the imagination and will inspire new creations.

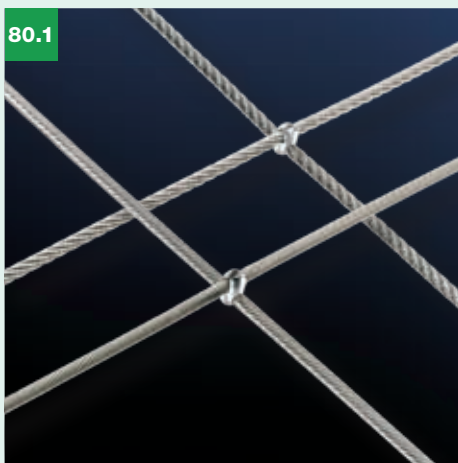

Crossnet 2 mm, No. 30586-0200

- Minimum mesh aperture: 40 mm
- Stainless steel stranded wire, \varnothing 2.0 mm, 1 x 19
- Stainless steel ropes, \varnothing 2.0 mm, 6 x 7 + WC or 6 x 19 + WC rope construction

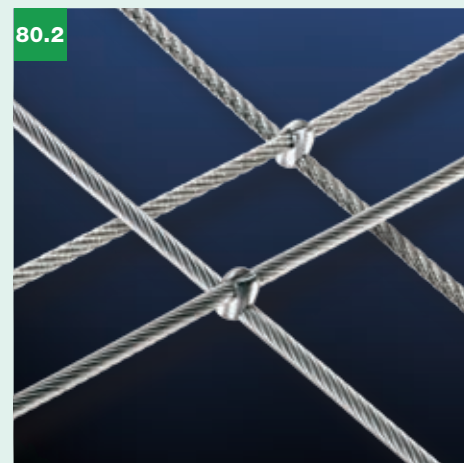

Crossnet 3 mm, No. 30586-0300

- Minimum mesh aperture: 40 mm
- Stainless steel stranded wire, \varnothing 3.0 mm, 1 x 19
- Stainless steel ropes, \varnothing 3.0 mm, 6 x 7 + WC or 6 x 19 + WC rope construction

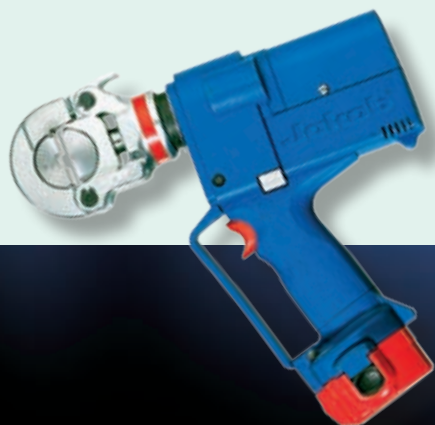

Crossnet frames

The wire-rope and stranded-wire sections can be combined with the extensive selection of end connectors featured in the **Jakob®** INOX LINE range.

80.3

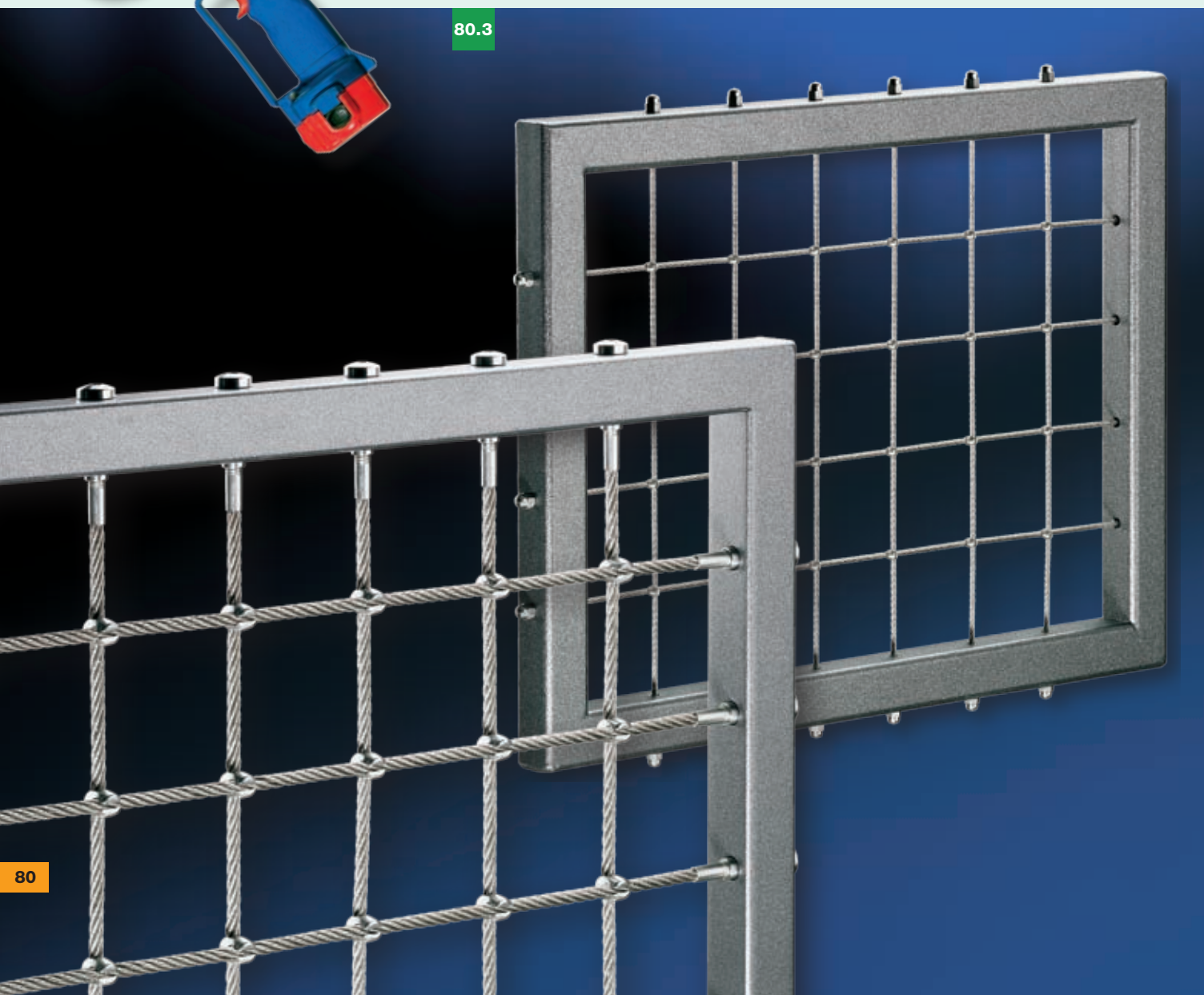

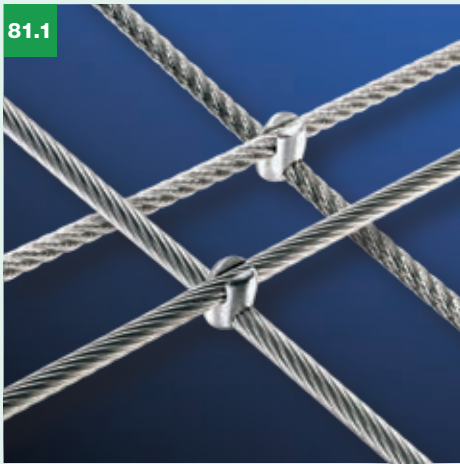

81.1

Crossnet 4 mm, No. 30586-0400

- Minimum mesh aperture: 60 mm
- Stainless steel stranded wire, Ø 4.0 mm, 1 × 19
- Stainless steel ropes, Ø 4.0 mm, 6 × 7 + WC or 6 × 19 + WC rope construction

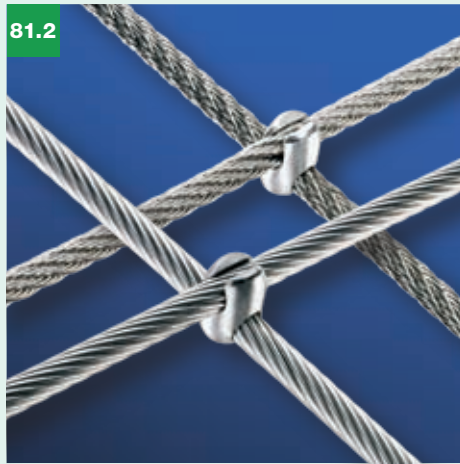

81.2

Crossnet 5 mm, No. 30586-0500

- Minimum mesh aperture: 60 mm
- Stainless steel stranded wire, Ø 5.0 mm, 1 × 19
- Stainless steel ropes, Ø 5.0 mm, 6 × 7 + WC or 6 × 19 + WC rope construction



81.3

Crossnet 6 mm, No. 30586-0600

- Minimum mesh aperture: 60 mm
- Stainless steel stranded wire, Ø 6.0 mm, 1 × 19
- Stainless steel ropes, Ø 6.0 mm, 6 × 7 + WC or 6 × 19 + WC rope construction

Special Crossnet designs

A combination of stainless steel ropes and stranded wire, with different rope and strand diameters.



81.4



81.5



82.3



82.1



82.2



82.4

82.5

Frankfurt Airport (D)
Projectile trap

- Crossnet rope \varnothing 2.0 mm, mesh aperture 50 mm
- Crossnet size total: 2600 m²

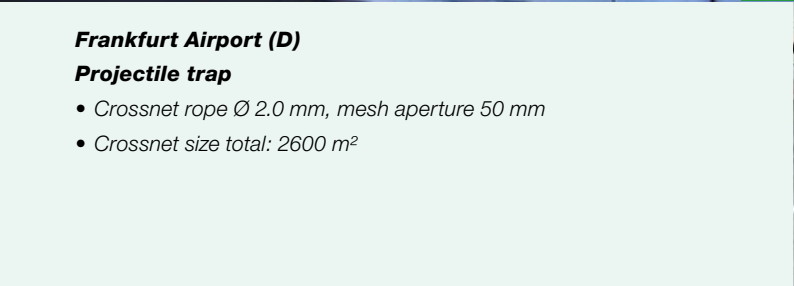

N₂

 Swiss
Quality

SINCE 1904



Basic

5.1



- D:** Ganz schön kreativ, was Sie mit **Jakob**® INOX LINE 5.1 gestalten können. In unserem 116-seitigen Hauptkatalog finden Sie die Lösung.
- F:** A peine croyable, tout ce que vous pouvez réaliser avec le catalogue **Jakob**® INOX LINE 5.1. Sur les 116 pages de notre catalogue général, vous trouverez la solution appropriée.
- E:** You can be so creative with **Jakob**® INOX LINE 5.1 and you'll find all the inspiration you need in our 116-page main catalogue.
- I:** Nessun limite alla vostra creatività, grazie a **Jakob**® INOX LINE 5.1. Le 116 pagine del nostro catalogo generale vi presentano allettanti proposte.

Green Solutions

G1



- D:** Die Fassadenbegrünung bekommt eine neue Dimension mit **Jakob**® INOX LINE G1. Auf 68 Seiten finden Sie moderne und ökologische Ideen.
- F:** La végétalisation des façades revêt une nouvelle dimension grâce à **Jakob**® INOX LINE G1. Des idées écologiques et modernes vous attendent sur les 68 pages conçues à votre attention.
- E:** **Jakob**® INOX LINE G1 creates a new dimension in the art of façade greening. You'll find contemporary and ecological ideas in this 68-page catalogue.
- I:** L'inverdimento delle facciate acquista una nuova dimensione con **Jakob**® INOX LINE G1. Il nostro catalogo vi propone 68 pagine ricche di idee moderne e ecologiche.

News

X



- D:** Neuheiten und sinnvolle Ergänzungen: Bestellen Sie den 68-seitigen NEWS-Katalog von **Jakob**® INOX LINE.
- F:** Nouveautés et suppléments judicieux sur 68 pages: commandez le catalogue NEWS de **Jakob**® INOX LINE.
- E:** New products and useful additions: Please order the 68-page NEWS catalogue from **Jakob**® INOX LINE.
- I:** 68 pagine di novità e significativi integrazioni: ordinate ancora oggi il catalogo NEWS di **Jakob**® INOX LINE.

Ihr **Jakob**® INOX LINE Partner
Votre partenaire **Jakob**® INOX LINE
Your **Jakob**® INOX LINE Distributor
Il vostro interlocutore **Jakob**® INOX LINE

Jakob® INOX LINE

... rostfreie Drahtseile
und Endverbindungen
mit den unendlichen
Kombinationsmöglichkeiten.

... câbles et éléments inox
pour une gamme d'utilisations
illimitées.

... stainless steel wire rope
products and connectors
for an unlimited range
of applications.

... funi di acciaio inossidabile
e terminali che consentono
un'innumerabile varietà di
combinazioni.

In über 50 Ländern sind wir für Sie da:
Nous sommes à votre disposition dans plus de 50 pays:
Worldwide presence in over 50 countries:
Siamo presenti in oltre 50 paesi:

Europe • Austria • Belgium • Bulgaria • Croatia • Cyprus • Denmark • Finland • France • Germany • Greece • Hungary • Ireland • Italy • Lithuania • Luxembourg • Macedonia • Netherlands • Norway • Poland • Portugal • Romania • Russia • Slovakia • Slovenia • Spain • Sweden • Switzerland • Turkey • United Kingdom • **Asia and Far East** • China • Hong Kong • India • Japan • Korea • Malaysia • Singapore • Taiwan • Thailand • **Australia** • Australia • **North America** • Canada • USA • **South America** • Argentina • Uruguay • El Salvador • **Mediterranean and Africa** • Dubai/UAE • Israel • Lebanon • South Africa

Für alle übrigen Informationen wenden Sie sich bitte an: / Pour de plus amples renseignements, veuillez s.v.p. contacter:
For any other information please contact: / Per qualsiasi informazione, vogliate rivolgervi a:

Jakob AG, Drahtseilfabrik, CH-3555 Trubschachen, Switzerland
Tel. +41 (0)34 495 10 10, Fax +41 (0)34 495 10 25
www.jakob.ch, eMail: inox@jakob.ch

Katalogbestellungen unter:
Commandez votre catalogue sous:
Order your catalogue under:
Per richiedere il catalogo basta accedere a:

www.jakob.ch

Printed in Switzerland, December 2007
© Copyright by Jakob AG, Switzerland 1988 / 2007
Idea & Conception by Atelier Jakob AG, CH-1763 Barberêche